

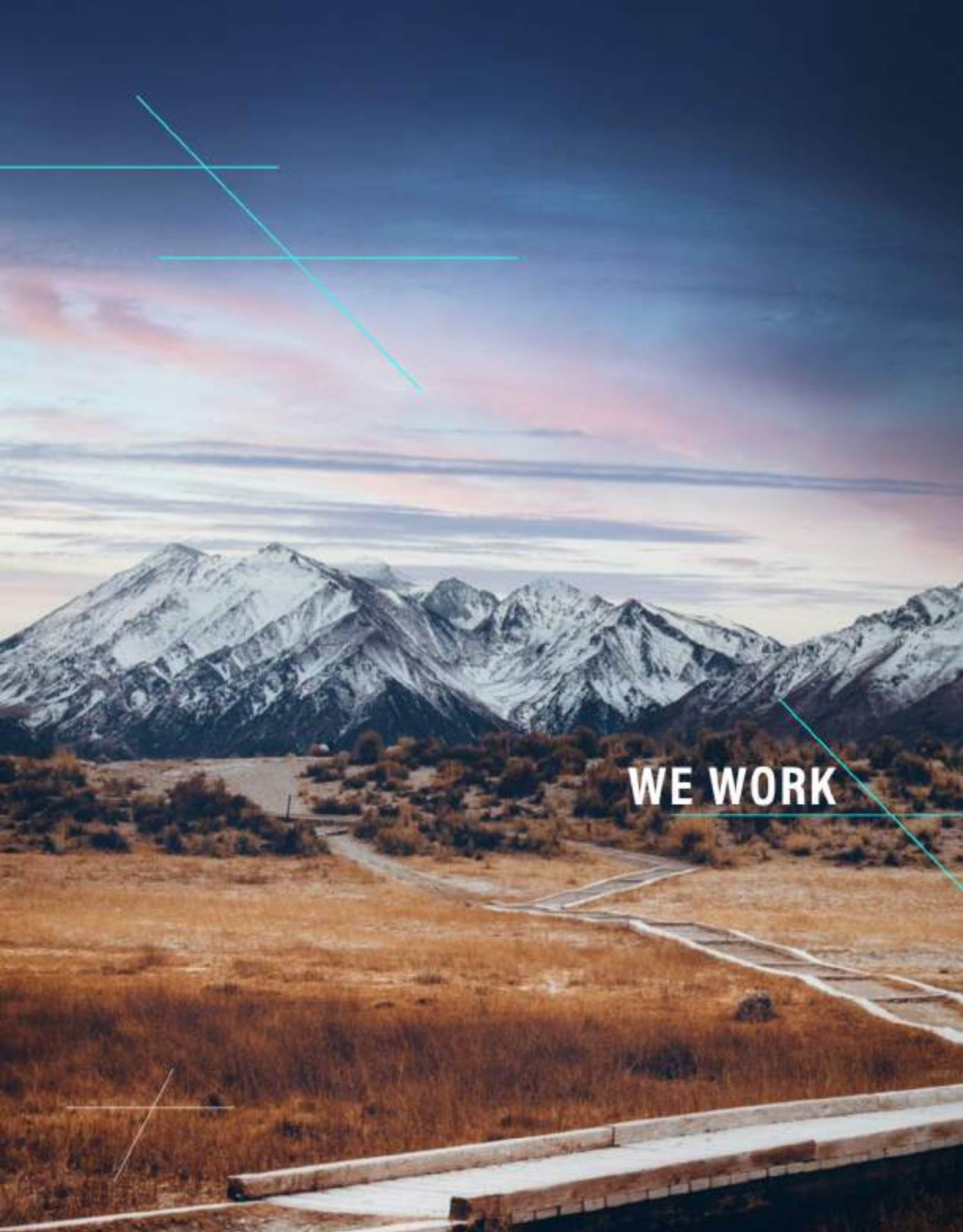

A M E R I C A N O U T D O O R
B R A N D S



W H O L E S A L E C A T A L O G
2 0 2 1



WE WORK

WHO WE ARE

We are passionate about the activities we pursue to the point that those around us cannot understand. As **VISIONARIES**, we lay at night under the stars, wondering if there are better views somewhere else, ready to take on the next adventure before the current one is even over. Reflecting from the top of mountains, we are left with pleasant exhaustion after an intense climb, **FEARLESSLY** planning the next one that will be a little more challenging.

We daydream about working the land in preparation for the next hunting season, continually finding ways to improve upon the previous year's results. We transition to **RELENTLESSLY** chasing that ever-elusive trophy that, even when faced with failure, somehow fuels the following year's daydreams.

We set out in pursuit, **INQUISITIVE** about the weather, geography, and what's around the next corner or over the next horizon to find the ideal spot. Questioning our judgment, regardless of the day's success, we watch the sun go down as our vessels head to shore, left believing tomorrow could be better.

We go to the range intent on improving our skills, for whatever our favored discipline may be, **AMBITIOUS** to become the most accurate and precise.

Regardless of the activity, the outdoors calls us in **COLLABORATION**, to share the moments that matter, in a way that delivers satisfaction through failures and success. A never-ending battle between us and our "hobbies" that always leaves us wanting....

WHERE WE PLAY!

Turning pursuit into passion, AOB delivers brands that move you because our success is measured by moments that matter.



TABLE OF CONTENTS

ADVENTURER

BUBBA
06

SCHRADE
45

IMPERIAL
108

 **ust**
120

HARVESTER

 **BOG**
164

 Hobymen
191

 **OLD TIMER**
215

Uncle Range
241

MARKSMAN

CALDWELL
262

 **FRANKFORD
ARSENAL**
297

Tipton
320

Wheeler
338

DEFENDER

 **CRIMSON TRACE**
384

 **S&W**
433

 **LOCKDOWN**
444

CUTLERY

 **M&P**
465

 **Smith & Wesson**
502

 **Performance
Center**
509

ACCESSORIES

 **Smith & Wesson**

575

 **M&P**
Smith & Wesson



BUBBA™

2021 NEW PRODUCTS

OUR STORY

Everyday we are living *The Ultimate Lifestyle*™ - making the most innovative, durable, and essential tools and gear designed for one thing alone: success on the water.

As creators of the iconic, *NON-SLIP GRIP* we're in relentless pursuit of consistently upping our game. That's why we continue to grow our versatility and offerings, while always staying true to our DNA.

2021 will be an exciting year as we continue to amplify BUBBA as a premium lifestyle brand through introduction of new tools and accessories, while also expanding into new and exciting categories, that were previously uncharted waters.



1135880

PRO SERIES LITHIUM ION ELECTRIC FILLET KNIFE



CONSTRUCTION

Blades:
TIN-Coated Premium Stainless Steel



Handle:
 Textured,
 Non-Slip Grip

FEATURES

- Brushless Motor
- 4 Blades Included
 7" E-FLEX
 9" 12" E-STIFF
- Aluminum & Polymer Construction
- Premium Hard Sided Carry Case
- Easy Clean Surface
- Includes 2 Standard 3,500 mAh Lithium Ion Batteries
- LED Battery Life Indicator



SPECS

Blade Lengths
 7" (17.78 cm)
 9" (22.86 cm)
 9" (22.86 cm)
 12" (30.48 cm)

UPC
 661120106166



8.5"

• ideal for **SM, MED & LG** size fish •



1142481

MAGNUM LITHIUM ION BATTERY PACK



CONSTRUCTION

Textured,
 Non-Slip Grip

FEATURES

- 50% More Power
- 7,000 mAh Lithium Ion
- 10V Output
- Premium Battery Life Indicator
- Compatible With All BUBBA EFK Models
- LED Battery Life Indicator



SPECS

RUNTIME
 1 Hour: Pro Series
 2 Hours: Lithium Ion

UPC
 661120106036



ELECTRIC FILLET KNIFE E-GLIDE BLADES

CONSTRUCTION	FEATURES	SPECS
TIN-Coated Premium Stainless Steel	<ul style="list-style-type: none"> • Less Aggressive Rounded Teeth Geometry • Serrated, Double-Cut Edge • Opposing, Bidirectional Blades • Precision-Ground • Dual-Rivet Blade Design on 8" Only 	Blade Lengths 7" (17.78 cm) 8" (20.32 cm)

• ideal for SM, MED & LG size fish •



1137448 7" (17.78 CM) E-GLIDE BLADE
UPC - 661120106128

1137449 8" (20.32 CM) E-GLIDE BLADE
UPC - 661120108135



• FLEX SCALE •
none ● extreme



• FLEX SCALE •
none ● extreme

1113227

220V ELECTRIC FILLET KNIFE



CONSTRUCTION

Blades:
TiN-Coated
Premium
Stainless Steel



Handle:
Textured,
Non-Slip Grip

FEATURES

- 4 Blades Included
7", 9" E-FLEX
9", 12" E-STIFF
- Dual-Rivet Blade Design on 9", 12" E-STIFF
- Ergonomic Trigger + Guard
- Premium EVA Case
- Easy Clean Surface
- Removable Blade Storage
- 8' Power Cord

SPECS

Blade Lengths
7" (17.78 cm)
9" (22.86 cm)
9" (22.86 cm)
12" (30.48 cm)

Handle Length
8.5" (21.59 cm)

UPC
661120080251

• ideal for SM, MED & LG size fish •



8" 8.5" (When Extended)



1113226

220V LITHIUM ION ELECTRIC FILLET KNIFE



CONSTRUCTION

Blades:
TiN-Coated
Premium
Stainless Steel



Handle:
Textured,
Non-Slip Grip

FEATURES

- 4 Blades Included
7", 9" E-FLEX
9", 12" E-STIFF
- Dual-Rivet Blade Design on 9", 12" E-STIFF
- Ergonomic Trigger + Guard
- Quiet Operation
- Ultra-Durable Construction
- Premium EVA Case
- Includes 2 Lithium Ion Batteries
- Includes Power-Charging Cord
- LED Battery Life Indicator



SPECS

Blade Lengths
7" (17.78 cm)
9" (22.86 cm)
9" (22.86 cm)
12" (30.48 cm)

Handle Length
8.5" (21.59 cm)

UPC
661120080288

• ideal for SM, MED & LG size fish •



8.5"



1134164

FRESHWATER MULTI-FLEX™ INTERCHANGEABLE SET



CONSTRUCTION

Blades:
TIN-Coated
High Carbon
Stainless Steel
Full-Tang

Handle:
Textured,
Non-Slip Grip



FEATURES

- 2 Blades Included
 7" Tapered Flex
 8" Ultra Flex
- Seamless Fixed Blade Performance
- Ergonomic Trigger + Guard
- Lanyard Hole
- Premium Hard Case Stores up to 4 Blades
- Flex-Change™ Locking System

SPECS

Blade Lengths
 7" (17.78 cm)
 8" (20.32 cm)

Handle Length
 6" (15.24 cm)

UPC
 661120106142

• Full-Tang, Flex-Change™ Locking System •



• ideal for **SM & MED** size fish •



6"



7" Tapered Flex



8" Ultra Flex

*Upgraded to a premium hard sided case

1134165

SALTWATER MULTI-FLEX™ INTERCHANGEABLE SET



CONSTRUCTION

Blades:
TIN-Coated
High Carbon
Stainless Steel
Full-Tang

Handle:
Textured,
Non-Slip Grip



FEATURES

- 2 Blades Included
 7" Tapered Flex
 9" Stiff
- Seamless Fixed Blade Performance
- Ergonomic Trigger + Guard
- Lanyard Hole
- Premium Hard Case Stores up to 4 Blades
- Flex-Change™ Locking System

SPECS

Blade Lengths
 7" (17.78 cm)
 9" (22.86 cm)

Handle Length
 6" (15.24 cm)

UPC
 661120106159

• Full-Tang, Flex-Change™ Locking System •



• ideal for **MED & LG** size fish •



6"



7" Tapered Flex



9" Stiff

*Upgraded to a premium hard sided case

MULTI-FLEX™ KNIFE BLADES

CONSTRUCTION	FEATURES	SPECS
TIN-Coated Premium Stainless Steel 	<ul style="list-style-type: none"> Serrated Double-Cut Edge Compatible with all Multi-Flex Handles Titanium-Nitride Coating Ultimate Corrosion Resistance Precision-Ground 	Blade Lengths 7" (17.78 cm) 8" (20.32 cm) 9" (22.86 cm)

• ideal for **SM & MED** size fish •



1138675 7" (17.78 CM) TAPERED FLEX BLADE

UPC - 661120106081

1138676 8" (20.32 CM) ULTRA FLEX BLADE

UPC - 661120106098

1138678 9" (22.86 CM) STIFF BLADE

UPC - 661120106111

1138677 9" (22.86 CM) SERRATED FLEX BLADE

UPC - 661120106104



• FLEX SCALE •



• FLEX SCALE •

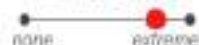

• FLEX SCALE •



• FLEX SCALE •





KITCHEN SERIES

BUBBA will begin establishing a presence within the kitchen through the continued commitment of superior quality and craftsmanship for cutlery products through the introduction of high-end kitchen knives for professional chefs and everyday culinary enthusiasts. BUBBA will expand its line of knives to include a range of professional quality traditional kitchen knives and an electric knife that are tastefully designed to match your kitchen décor through the quality craftsmanship of a G10 Handle and premium German Steel for an extremely sharp, long-lasting edge.



1135883

KITCHEN SERIES ELECTRIC KNIFE



CONSTRUCTION
Blades:
Premium Polished
Stainless Steel

Handle:
Textured

FEATURES

- 3 Blades Included
2 Meat Knives
1 Bread Knife
- Optimized Motor Output
- Integrated Lithium Ion Battery
- 5' Charging Cord Included
- LED Battery Life Indicator

SPECS

Blade Lengths
6" Carving (15.24 cm)
7" Carving (17.78 cm)
9" Bread (22.86 cm)

UPC
661120106203



6" CARVING BLADE

7" CARVING BLADE

9" BREAD BLADE

1137661

COMPLETE KITCHEN & STEAK KNIFE SET



CONSTRUCTION
Blades:
Premium German
Stainless Steel

Handle:
Expertly Crafted
G10 Material

Rockwell Hardness:
60

FEATURES

- 11 Blades Included
8" Honing Rod
8" Chef Knife
8" Serrated Knife
7" Santoku Knife
6.5" Nakiri Knife
6" Utility Knife
4.5" Steak Knives (4 total)
3.5" Paring Knife
- Stylish Knife Block
- Detachable Steak Knife Section
- Iconic BUBBA™ Quality Craftsmanship
- Extremely Sharp, Long-Lasting Edge

SPECS

Blade Lengths
3.5" (8.89 cm)
4.5" (11.43 cm)
6" (15.24 cm)
6.5" (16.51 cm)
7" (17.78 cm)
8" (20.32 cm)
9" (22.86 cm)

UPC
661120106197



1135891

KITCHEN KNIFE SET



CONSTRUCTION

Blades:
Premium German
Stainless Steel

Handle:
Expertly Crafted
G10 Material

Rockwell Hardness:
60

FEATURES

- 7 Blades Included
 - 9" Howing Rod
 - 8" Chef Knife
 - 8" Serrated Knife
 - 7" Santoku Knife
 - 6.5" Nakiri Knife
 - 6" Utility Knife
 - 3.5" Paring Knife
- Stylish Knife Block
- Iconic BUBBA™ Quality Craftsmanship
- Extremely Sharp, Long-Lasting Edge

SPECS

Blade Lengths
3.5" (8.89 cm)
6" (15.24 cm)
6.5" (16.51 cm)
7" (17.78 cm)
8" (20.32 cm)
9" (22.86 cm)

UPC
661120106227



1137660

STEAK KNIFE SET



CONSTRUCTION

Blades:
Premium German
Stainless Steel

Handle:
Expertly Crafted
G10 Material

Rockwell Hardness:
60

FEATURES

- 4 Blades Included
 - 4.5" Steak Knives
- Stylish Knife Storage
- Easily Attaches to the Kitchen Knife Block
- Iconic BUBBA™ Quality Craftsmanship
- Extremely Sharp, Long-Lasting Edge

SPECS

Blade Lengths
4.5" (11.43 cm)

UPC
661120106258



INDIVIDUAL KITCHEN KNIVES

CONSTRUCTION

Blades:
Premium German
Stainless Steel

Handle:
Expertly Crafted G10
Material

Rockwell Hardness:
60

FEATURES

- Perfectly Balanced Weighted for Cutting & Dicing
- Iconic BUBBA™ Quality Craftsmanship
- Extremely Sharp, Long-Lasting Blade Edge



1114266 3.5" (8.89 CM) PARING KNIFE
UPC - 661120106234



1114268 6" (15.24 CM) UTILITY KNIFE
UPC - 661120106265



1151297 6.5" (16.51 CM) NAKIRI KNIFE
UPC - 661120263326



1114265 7" (12.70 CM) SANTOKU KNIFE
UPC - 661120106180



1114253 8" (20.32 CM) CHEF KNIFE
UPC - 661120106173



1114267 8" (20.32 CM) SERRATED CHEF KNIFE
UPC - 661120106241



1135889 9" (22.86 CM) HONING ROD
UPC - 661120106210



SEAKER™ BAG SERIES

BUBBA will begin offering a collection of premium dry and travel bags constructed for maximum durability and minimal weight, making these bags the perfect companion for any angler hitting the water or simply hitting the road for the next adventure.



1116740

SEAKER™ 10L HIP PACK



CONSTRUCTION
 TPU Laminates
 600D Waterproof/
 PU Coated 210D
 Water Resistant
 Polyester

**Waterproof Base
 Construction**

**Adjustable Padded
 Hip/Shoulder
 Strap, Removable**

FEATURES

- Technically Advanced, Purpose-Built Dry Pack
- Specifically Built for Multiple Days on the Water
- Strategically Placed Waterproof Features, Water-Resistant Throughout
- Multiple Storage Components Specifically Built for BUBBA™ Products
- Molded EVA Front Storage Compartment (Hook Keeper on Inside)
- Magnetic, Double YKK® Zippered Closure for Main Compartment
- Coated Loops for Carabiner Attachments
- Extra Storage Pouches for Smaller Items
- Beer/Water Bottle Storage

SPECS

CAPACITY
 10L (810.237
 Cubic Inches)

UPC
 601120080200



*Does not include physical tackle box storage

1114247

SEAKER™ 10L SLING PACK



CONSTRUCTION

TPU Laminate
600D Waterproof/
PU Coated 210D
Water Resistant
Polyester

Waterproof Base
Construction

Adjustable Padded
Strap

FEATURES

- Technically Advanced, Purpose-Built Dry Pack
- Specifically Built for Multiple Days on the Water
- Strategically Placed Waterproof Features, Water-Resistant Throughout
- Multiple Storage Components Specifically Built for BUBBA™ Products
- Adjustable Padded Shoulder Strap
- Water-Resistant, Outside YKK® Zipper
- Coated Loops for Carabiner Attachments
- Extra Storage Pouches for Smaller Items
- Beer/Water Bottle Storage
- Rod Holder Loop

SPECS

CAPACITY
10L (610.237
Cubic Inches)

UPC
661120080213



*Does not include physical tackle box storage

1114250

SEAKER™ 62L DUFFEL PACK



CONSTRUCTION

TPU Laminate
600D Waterproof/
PU Coated 210D
Water Resistant
Polyester

Waterproof Base
Construction

Quick-Detach
Adjustable Padded
Backpack Straps
+ Storage Sleeve
in Lid

FEATURES

- Ideal for Travel
- Technically Advanced, Purpose-Built Portable Fishing Dry Duffel
- Specifically Built for Multiple Days on the Water
- Strategically Placed Waterproof Features, Water-Resistant Throughout
- Multiple Storage Components Specifically Built for BUBBA™ Products
- Padded Carry Handles on All Sides
- Mesh Side Pocket with Expandable Zippered Space for Shoes/Dirty/Wet Items
- Cut-Resistant, EVA Molded BUBBA™ Grip on Bottom
- "Daisy-Chain" Loops for Securing Additional Gear
- Quick-Access Lid + Oversized YKK® Zippers + Rainguard Protection (Covers Zippers for Rain Protection)

SPECS

CAPACITY
62L (3783.47
Cubic Inches)

UPC
661120080237



*Does not include physical tackle box storage



RETURNING PRODUCTS



1111856

PADDOC™ SHUCKING KNIFE



CONSTRUCTION	FEATURES	SPECS
Blade: High-Strength 440C Steel Full-Tang	<ul style="list-style-type: none"> • Curved Tip for Maximum Leverage • Designed for Comfort 	Blade Length 2.5" (6.35 cm) Overall Length 6.5" (16.51 cm) UPC 661120079927
Handle: Textured, Non-Slip Grip		



• ideal for oysters •



UTILITY

1989606

PROTEUS™ ULU KNIFE



CONSTRUCTION

Blade:
TIN-Coated
Full-Tang



Handle:
Textured,
Non-Slip Grip

FEATURES

- Designed for Maximum Comfort
- Curved Blade for Effortless Cuts
- Thumb Grip for Sheath Removal
- Integrated Bottle Opener

SPECS

Blade Width
5.75" (14.6 cm)
Overall Height
5" (12.7 cm)
UPC
661120079842



• ideal for **SM, MED & LG** size fish and culinary preparation •



1116742

BUBBA™ TAPE



CONSTRUCTION

Iconic,
Non-Slip Grip

Resilient Material

FEATURES

- Endless Utility
- Easy Application

SPECS

Overall Length
96" (243.84 cm)
UPC
661120080244

1107806



SCOUT™ SERIES

3.5" POINTED SCOUT™ KNIFE

CONSTRUCTION

Blade:
TiN-Coated **TiN**
 Marine-Grade
 Stainless Steel
 Full-Tang
 Handle:
 Textured,
 Non-Slip Grip
 Extreme
 Durability
 Sheath:
 Quick Lock &
 Release Design
 Lanyard Stow
 Notches

FEATURES

- Pointed-Style Piercing Tip
- Fast Cutting Serrated Edge
- Multi-Function Sharp Edge
- Line Cutter
- Spear Shaft Retrieval Notch
- Full-Tang Tank Tappers
- Dual Lanyard Holes (Lanyard Included)
- Contoured Sheath for on Body Comfort
- Adjustable Body Straps Included

SPECS

Blade Length
 3.5" (8.89 cm)
 Overall Length
 7.5" (19.05 cm)
 UPC
 661120079538



• ideal for diving/utility purposes •

1107809



SCOUT™ SERIES

4" BLUNT SCOUT™ KNIFE

CONSTRUCTION

Blade:
TiN-Coated **TiN**
 Marine-Grade
 Stainless Steel
 Full-Tang
 Handle:
 Textured,
 Non-Slip Grip
 Extreme
 Durability
 Sheath:
 Quick Lock &
 Release Design
 Lanyard Stow
 Notches

FEATURES

- Blunt-Style Utility Tip
- Fast Cutting Serrated Edge
- Multi-Function Sharp Edge
- Line Cutter
- Spear Shaft Retrieval Notch
- Full-Tang Tank Tappers
- Dual Lanyard Holes (Lanyard Included)
- Contoured Sheath for on Body Comfort
- Adjustable Body Straps Included

SPECS

Blade Length
 4" (10.16 cm)
 Overall Length
 9" (22.86 cm)
 UPC
 661120079521



• ideal for diving/utility purposes •

1112805



WIRE CUTTERS

CONSTRUCTION

Jaws:
TIN-Coated 
Stainless Steel

Body:
Corrosion-
Resistant

Handle:
Textured,
Non-Slip Grip

FEATURES

- Cut Through Wire, Leaders or Cable with Ease
- Strong, Durable
- Spring-Loaded
- Lanyard Hole

SPECS

Blade Length
2" (5.08 cm)
Overall Length
7" (17.78 cm)
UPC
661120079941



• ideal for cutting wire, leaders or cable •

1099913



SMALL SHEARS

CONSTRUCTION

Blades:
TIN-Coated 
Full-Tang

Handle:
Textured,
Non-Slip Grip

FEATURES

- Micro-Serrated Blades
- Grip Support
- Split Shot Crimper
- Bottle Opener
- Lanyard Hole

SPECS

Blade Length
2" (5.08 cm)
Overall Length
6" (15.24 cm)
UPC
661120079906



• ideal for cutting monocrystal, fluorocarbon and braided line •

1099914

MEDIUM SHEARS



CONSTRUCTION

Blades:
TiN-Coated
Full-Tang
Removable



Handle:
Textured,
Non-Slip Grip

FEATURES

- Micro-Serrated Blades
- Fish Descaler
- Hook Eye Cleaner
- Hook Sharpener
- Crimper Tool
- Bottle Opener
- Lanyard Hole

SPECS

Blade Length
3" (7.62 cm)
Overall Length
7.5" (15.24 cm)
UPC
661120080008



--- 3" ---

--- 7.5" ---

• ideal for cutting monocrabon, flurocarbon and braided line •

1099915

LARGE SHEARS



CONSTRUCTION

Blades:
TiN-Coated
Full-Tang
Removable



Handle:
Textured,
Non-Slip Grip

FEATURES

- Micro-Serrated Blades
- Extra Sharp for Precision
- Bottle Opener
- Integrated Carabiner

SPECS

Blade Length
3" (7.62 cm)
Overall Length
8.5" (21.59 cm)
UPC
661120080015

CUTTING EDGE

BELLYPOCKET CLIP SHEATH

- Molded Polymer
- Lightweight
- Water-Resistant



--- 3" ---

--- 8.5" ---

• ideal for cutting rope, monocrabon, flurocarbon and braided line •

1121112



LINE NIPPER & TETHER COMBO

CONSTRUCTION

Corrosion-Resistant

Durable Finish



FEATURES

- Mechanical Design to Increase Leverage and Cutting Power
- Serrated Nipper Edge
- Non-Slip Finger Pads
- Spring-Loaded
- Integrated Carabiner
- Hook Eye Cleaner
- Tether Lanyard System

SPECS

Overall Length
6" (15.24 cm)
Tether Extended
42" (106.68 cm)
UPC
661120080183

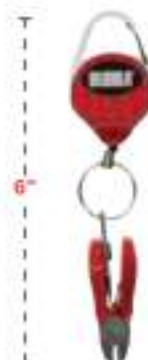

• ideal for cutting **monocarbon, fluocarbon and braided line** •

1116530



TOOL TETHER

CONSTRUCTION

Corrosion-Resistant

Durable Finish

FEATURES

- Fish Scale Accent
- Swivel for Line Attachment
- Integrated Carabiner
- Portable
- Durable

SPECS

Overall Length
3.5" (8.89 cm)
Tether Extended
30" (90.06 cm)
UPC
661120080275



• ideal for **gear security** •

1095704

110V ELECTRIC FILLET KNIFE



CONSTRUCTION

Blades:
TIN-Coated
Premium
Stainless Steel

TIN

Handle:
Textured,
Non-Slip Grip



FEATURES

- 4 Blades Included
7", 9" E-FLEX
9", 12" E-STIFF
- Dual-Rivet Blade Design
on 9", 12" E-STIFF
- Ergonomic Trigger + Guard
- Premium EVA Case
- Easy Clean Surface
- Removable Blade
Storage
- 8' Power Cord

SPECS

Blade Lengths
7", 9", 9", 12"
Handle Length
8.5" (21.59 cm)
Handle Weight
1.11 lbs.
Package Weight
7.63 lbs
UPC
061120410111

• Ideal for **SM, MED & LG** size fish •



8' 8.5"
(When Extended)



1095705

LITHIUM ION ELECTRIC FILLET KNIFE



CONSTRUCTION

Blades:
TiN-Coated
Premium
Stainless Steel

TIN

Handle:
Textured,
Non-Slip Grip

FEATURES

- 4 Blades Included
7", 9" E-FLEX
9", 12" E-STIFF
- Dual-Rivet Blade Design
on 9", 12" E-STIFF
- Ergonomic Trigger + Guard
- Quiet Operation
- Ultra-Durable Construction
- Premium EVA Case
- Includes 2 Lithium Ion Batteries
- Includes Power-Charging Cord
- LED Battery Life Indicator

LED

SPECS

Blade Lengths
7", 9", 9", 12"
Handle Length
8.5" (21.59 cm)
Handle Weight
1.11 lbs.
Package Weight
7.63 lbs.
UPC
061120410128

• Ideal for **SM, MED & LG** size fish •



8.5"



ELECTRIC FILLET KNIFE BLADES

CONSTRUCTION	FEATURES	SPECS
TIN-Coated Premium Stainless Steel	<ul style="list-style-type: none"> Serrated, Double-Cut Edge Opposing Bidirectional Blades Precision-Ground Dual-Rivet Blade Design on 9", 12" E-STIFF 	Blade Lengths 7" (17.78 cm) 9" (22.86 cm) 9" (22.86 cm) 12" (30.48 cm)

• ideal for **SM, MED & LG** size fish •



1099591 7" (17.78 CM) E-FLEX BLADE

UPC - 661120418825

1099592 9" (22.86 CM) E-FLEX BLADE

UPC - 661120418832

1099593 9" (22.86 CM) E-STIFF BLADE

UPC - 661120418849

1099594 12" (30.48 CM) E-STIFF BLADE

UPC - 661120418856



• FLEX SCALE •
 none —●— extreme



• FLEX SCALE •
 none —●— extreme



• FLEX SCALE •
 none —●— extreme



• FLEX SCALE •
 none —●— extreme



GAFFS

1116733

SMALL PORTABLE GAFF



CONSTRUCTION

17-FH
High-Strength
Stainless Steel

Textured,
Non-Slip Grip

Carbon Fiber
Handle

FEATURES

- Offset Hook Design
- Designed to Fit Most Rod Holders
- Detachable Hook Cover



SPECS

Overall Length
3" Hook (7.62 cm)
3' (91.44 cm)

UPC
061120079934



• ideal for SM, MED & LG size fish •



BUBBA™ GAFFS

CONSTRUCTION

Hook:
Nitronic 50
Stainless Steel

Handle:
Textured,
Non-Slip Grip

FEATURES

- Offset Hook Design
- 3.5mm Thick, Carbon Fiber Shaft
- Designed to Fit Most Rod Holders

SPECS

Overall Lengths
3" Hook, 5' (7.62 cm, 152.4 cm)
4" Hook, 5' (10.16 cm, 152.4 cm)
3" Hook, 7' (7.62 cm, 213.36 cm)
4" Hook, 7' (10.16 cm, 213.36 cm)

• Ideal for **SM, MED & LG** size fish •



• FLEX SCALE •



1095935 **3" HOOK, 5' GAFF**

UPC - 661120418351

1099741 **4" HOOK, 5' GAFF**

UPC - 661120418368

1099742 **3" HOOK, 7' GAFF**

UPC - 661120418771

1099743 **4" HOOK, 7' GAFF**

UPC - 661120418788



BUBBA™ FISHING NETS



CONSTRUCTION

Hoop:
Reinforced
Aerospace
Aluminum

Handle:
Textured,
Non-Slip Grip
2mm Thick,
Carbon Fiber
Handle

FEATURES

- 30-lb. Weight-Rated (SM)
- 50-lb. Weight-Rated (MED & LG)
- Corrosion-Resistant
- Designed to Fit Most Rod Holders
- No Structural Plastic

SPECS

Net Lengths
4" (121.92 cm)
5.5" (167.64 cm)
6" (182.88 cm)

Net Widths
16" (40.64 cm)
20" (50.8 cm)
24" (60.96 cm)

• Ideal for **SM, MED & LG** size fish •



• FLEX SCALE •



- 1096052** **16" (40.64 CM) SMALL NET**
UPC - 661120418780
- 1098489** **20" (50.8 CM) MEDIUM NET**
UPC - 661120418901
- 1098490** **24" (60.96 CM) LARGE NET**
UPC - 661120418818



1116730

MEDIUM EXTENDABLE NET



CONSTRUCTION

Carbon Fiber and Reinforced Aluminum Handle

Textured, Non-Slip Grip



FEATURES

- PVC-Coated Nylon Net Material
- 50-lb. Weight-Rated (Extended Load)
- Corrosion-Resistant
- Designed to Fit Most Rod Holders
- Lightweight, Portable, Telescoping

SPECS

Net Length Extended
61"-79"
(154.94 cm-200.66 cm)
Net Width
20" (50.8 cm)
UPC
661120080180

↑
↓
20"
↑
↓



↑
↓
61"-79"
↑
↓



• ideal for **SM & MED** size fish •



1122182

LARGE EXTENDABLE NET



CONSTRUCTION

Carbon Fiber and Reinforced Aluminum Handle

Textured, Non-Slip Grip



FEATURES

- PVC-Coated Nylon Net Material
- 50-lb. Weight-Rated (Extended Load)
- Corrosion-Resistant
- Designed to Fit Most Rod Holders
- Lightweight, Portable, Telescoping

SPECS

Net Length Extended
66"-84"
(167.64 cm-213.36 cm)
Net Width
24" (60.96 cm)
UPC
661120080282

↑
↓
24"
↑
↓



↑
↓
66"-84"
↑
↓



• ideal for **MED & LG** size fish •





BUBBA™ ULTIMATE FILLET GLOVES

CONSTRUCTION

Strategically Placed Kevlar®
Protection Against Cuts/Punctures
Neoprene Back

FEATURES

- Non-Slip/Cut-Resistant Grip
- Highly-Visible, Reflective Paneling
- Touch-Screen Responsive Index Finger and Thumb

1105775 FILLET SM/MED

UPC - 661120076544

1099916 FILLET MED

UPC - 661120076551

1099917 FILLET LG

UPC - 661120076568

1099918 FILLET XL

UPC - 661120076575

1099919 FILLET XXL

UPC - 661120076681



BUBBA™ ULTIMATE FISHING GLOVES

CONSTRUCTION

Reinforced Kevlar®
Construction for Maximum Protection
Neoprene Back
Padded Palms

FEATURES

- Quick-Sweat Wipe, Terry Cloth Thumb
- Highly-Visible, Reflective Paneling
- Touch-Screen Responsive Index Finger and Thumb

1105776 FISHING SM/MED

UPC - 661120076698

1099920 FISHING MED

UPC - 661120076704

1099921 FISHING LG

UPC - 661120076711

1099922 FISHING XL

UPC - 661120076728

1099923 FISHING XXL

UPC - 661120076735

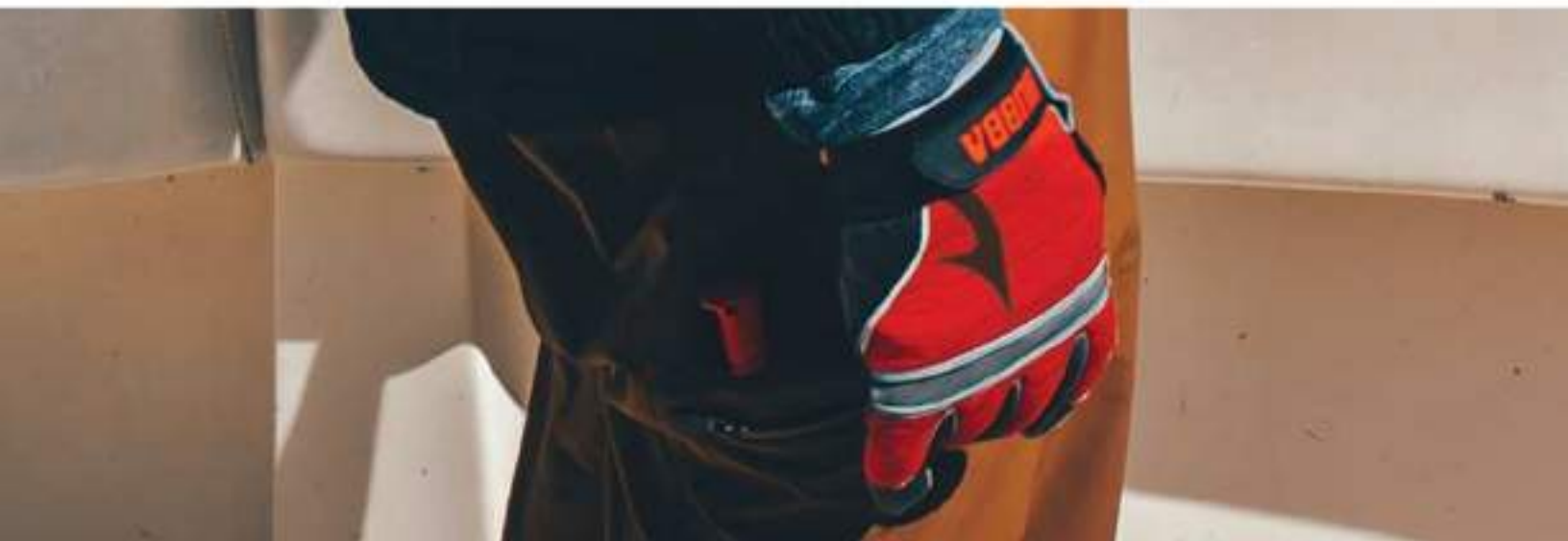



PLIERS

1085872

6.5" FISHING PLIERS



CONSTRUCTION

Jaws:
8Cr13MoV
Ti-Nitride 
Bonded, High
Carbon S.S.

Body:
Corrosion-
Resistant
Aluminum

Handle:
Textured,
Non-Slip Grip

FEATURES

- Split Ring Tip
- Carbide Cutters
- Crimper Tool
- Spring-Loaded
- Coiled Lanyard
- Lanyard Hole
- Synthetic Sheath

SPECS

Jaw Length
3" (7.62 cm)
Overall Length
6.5" (16.51 cm)
Weight
3.4 oz.
UPC
061120412050



6.5"

1085874

8.5" FISHING PLIERS



CONSTRUCTION

Jaws:
8Cr13MoV
Ti-Nitride 
Bonded, High
Carbon S.S.
Body:
Corrosion-
Resistant
Aluminum

Handle:
Textured,
Non-Slip Grip

FEATURES

- Carbide Cutters
- Side Cutter
- Crimper Tool
- Spring-Loaded
- Coiled Lanyard
- Lanyard Hole
- Synthetic Sheath

SPECS

Jaw Length
4" (10.16 cm)
Overall Length
8.5" (21.59 cm)
Weight
6.2 oz.
UPC
061120413271



8.5"

BB1-FP

7.5" FISHING PLIERS



CONSTRUCTION

Jaws:
8Cr13MoV
Ti-Nitride 
Bonded, High
Carbon S.S.
Body:
Corrosion-
Resistant
Aluminum

Handle:
Textured,
Non-Slip Grip

FEATURES

- Side Cutter
- 3-Set Crimper Tool
- Spring-Loaded
- Coiled Lanyard
- Lanyard Hole
- Synthetic Sheath

SPECS

Jaw Length
2" (5.08 cm)
Overall Length
7.5" (19.05 cm)
Weight
5.5 oz.
UPC
019962430848



7.5"

1085969

6.5" PISTOL GRIP PLIERS



CONSTRUCTION

Jaws:
8Cr13MoV **TiN**
Ti-Nitride
Bonded, High
Carbon S.S.

Body:
Corrosion-
Resistant
Aluminum

Handle:
Textured,
Non-Slip Grip

FEATURES

- Ring Splitter Tip
- Carbide Cutters
- Crimper Tool
- Spring-Loaded
- Coiled Lanyard
- Lanyard Hole
- Synthetic Sheath

SPECS

Jaw Length
3" (7.62 cm)
Overall Length
6.5" (16.51 cm)
Weight
3.7 oz.
UPC
661120414377



1085970

8.5" PISTOL GRIP PLIERS



CONSTRUCTION

Jaws:
8Cr13MoV **TiN**
Ti-Nitride
Bonded, High
Carbon S.S.

Body:
Corrosion-
Resistant
Aluminum

Handle:
Textured,
Non-Slip Grip

FEATURES

- Carbide Cutters
- Crimper Tool
- Spring-Loaded
- Coiled Lanyard
- Lanyard Hole
- Synthetic Sheath

SPECS

Jaw Length
4" (10.16 cm)
Overall Length
8.5" (21.59 cm)
Weight
7 oz.
UPC
661120414384



1099906

6.5" STAINLESS STEEL FISHING PLIERS



CONSTRUCTION

Jaws:
TiN-Coated 
High-Strength
Stainless Steel

Body:
Corrosion-
Resistant

Handle:
Textured,
Non-Slip Grip

FEATURES

- Carbide Cutters
- Crimper Tool
- Spring-Loaded
- Coiled Lanyard
- Lanyard Hole

CUTTING EDGE

SELF-POCKET CLIP SHEATH

- Molded Polymer
- Lightweight
- Water-Resistant

SPECS

Jaw Length:
2.5" (6.35 cm)
Overall Length:
6.5" (16.51 cm)
UPC:
661120079958



6.5"

1099910

8.5" STAINLESS STEEL FISHING PLIERS



CONSTRUCTION

Jaws:
TiN-Coated 
High-Strength
Stainless Steel

Body:
Corrosion-
Resistant

Handle:
Textured,
Non-Slip Grip

FEATURES

- Side Cutters
- Crimper Tool
- Spring-Loaded
- Coiled Lanyard
- Lanyard Hole

CUTTING EDGE

SELF-POCKET CLIP SHEATH

- Molded Polymer
- Lightweight
- Water-Resistant

SPECS

Jaw Length:
3.5" (8.89 cm)
Overall Length:
8.5" (21.59 cm)
UPC:
661120079965



8.5"

1099911

6.5" STAINLESS STEEL PISTOL GRIP PLIERS



CONSTRUCTION

Jaws:
TiN-Coated 
High-Strength
Stainless Steel

Body:
Corrosion-
Resistant

Handle:
Textured,
Non-Slip Grip

FEATURES

- Offers 90° Angle for Leverage in Hook Removal
- Carbide Cutters
- Spring-Loaded
- Crimper Tool
- Coiled Lanyard
- Lanyard Hole

CUTTING EDGE BELT/POCKET CLIP SHEATH

- Molded Polymer
- Lightweight
- Water-Resistant

SPECS

Jaw Length
2.5" (6.35 cm)
Overall Length
6.5" (16.51 cm)
UPC
661120079972



1099912

8.5" STAINLESS STEEL PISTOL GRIP PLIERS



CONSTRUCTION

Jaws:
TiN-Coated 
High-Strength
Stainless Steel

Body:
Corrosion-
Resistant

Handle:
Textured,
Non-Slip Grip

FEATURES

- Offers 90° Angle for Leverage in Hook Removal
- Carbide Cutters
- Spring-Loaded
- Crimper Tool
- Coiled Lanyard
- Lanyard Hole

CUTTING EDGE BELT/POCKET CLIP SHEATH

- Molded Polymer
- Lightweight
- Water-Resistant

SPECS

Jaw Length
3.5" (8.89 cm)
Overall Length
8.5" (21.59 cm)
UPC
661120079989



1109761

6" HOOK EXTRACTOR



CONSTRUCTION

Anodized
Aluminum Exterior
Stainless Steel
Interior

Textured,
Non-Slip Grip

FEATURES

- Marine Grade Stainless Steel Hook Extractor
- Ergonomically Designed for Comfort

SPECS

Handle Length
4.5" (11.43 cm)
Overall Length
10.5" (38.1 cm)
UPC:
661120079897



• ideal for **SM & MED** size fish •



1112867

12" HOOK EXTRACTOR



CONSTRUCTION

Anodized
Aluminum Exterior
Stainless Steel
Interior

Textured,
Non-Slip Grip

FEATURES

- Marine Grade Stainless Steel Hook Extractor
- Ergonomically Designed for Comfort

SPECS

Handle Length
4.5" (11.43 cm)
Overall Length
16.5" (41.91 cm)
UPC:
661120079873



• ideal for **MED & LG** size fish •



1112554

7" TAPERED FLEX FOLDING KNIFE

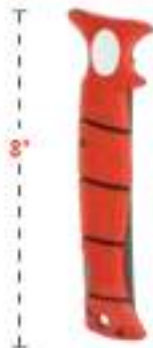

CONSTRUCTION

Blade:
TiN-Coated
High Carbon
Stainless Steel



Handle:
Textured,
Non-Slip Grip

FEATURES

- Flexible Blade
- Safety Guards
- Trigger Grip
- Lockback
- Lanyard Hole
- Synthetic Sheath

SPECS

Blade Length
7" (17.78 cm)
Overall Length
15" (38.1 cm)
UPC
601120079903

• Ideal for **MED & LG** size fish •



• FLEX SCALE •

none extreme



BB1-5FK

5" LUCKY LEW



CONSTRUCTION

Blade:
8Cr13MoV
Ti-Nitride
Bonded High
Carbon S.S.



Handle:
Textured,
Non-Slip Grip

FEATURES

- Lockback
- Safety Guards
- Trigger Grip
- Lanyard Hole
- Synthetic Sheath

SPECS

Blade Length
5" (12.7 cm)
Overall Length
11" (27.94 cm)
Weight
7.1 oz.
UPC
019962430947

• Ideal for **SM** size fish •



• FLEX SCALE •

none extreme



BB-CL-FK

4" SCULPIN



CONSTRUCTION

Blade:
8Cr13MoV,
Bonded High
Carbon S.S.

Handle:
G-10 Textured/S.S.

FEATURES

- Thin Profile
- Finger Flipper
- Liner Lock
- Pocket Clip
- Lanyard Hole

SPECS

Blade Length
4" (10.16 cm)
Overall Length
8.46" (21.5 cm)
Weight
5.3 oz.
UPC
853341606402

• Ideal for **SM, MED & LG** size fish •





1991724

MULTI-FLEX™ FULL-TANG INTERCHANGEABLE SET



CONSTRUCTION

Blades:
 TiN-Coated
 High Carbon
 Stainless Steel
 Full-Tang

Handle:
 Textured,
 Non-Slip Grip

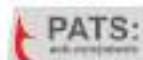

FEATURES

- Seamless Fixed Blade Performance
- 4 Blades Included
 7" Tapered Flex
 8" Ultra Flex
 9" Serrated Flex
 9" Stiff
- Ergonomic Trigger + Guard
- Lanyard Hole
- Premium EVA Case

SPECS

Blade Lengths
 7", 8", 9", 9"
 Handle Length
 6" (15.24 cm)
 UPC
 681120078545

• Full-Tang, Flex-Change™ Locking System •



• Ideal for SM, MED & LG size fish •



6"



7" Tapered Flex



8" Ultra Flex



9" Serrated Flex



9" Stiff

1085876

6" ULTRA FLEX



CONSTRUCTION	FEATURES	SPECS
Blade: 8Cr13MoV Ti-Nitride Bonded High Carbon S.S.	<ul style="list-style-type: none"> • Ultra-Thin Blade • Extreme Flex • Safety Guards • Trigger Grip • Lanyard Hole • Synthetic Sheath 	Blade Length 6" (15.24 cm) Overall Length 11" (27.94 cm) Weight 4.5 oz. UPC 601120414261

• Ideal for **SM** size fish •



• FLEX SCALE •



1085875

8" ULTRA FLEX



CONSTRUCTION	FEATURES	SPECS
Blade: 8Cr13MoV Ti-Nitride Bonded High Carbon S.S.	<ul style="list-style-type: none"> • Ultra-Thin Blade • Extreme Flex • Safety Guards • Trigger Grip • Lanyard Hole • Synthetic Sheath 	Blade Length 8" (20.32 cm) Overall Length 14.5" (36.83 cm) Weight 5.5 oz. UPC 601120414254

• Ideal for **MED & LG** size fish •



• FLEX SCALE •



BB1-7F

7" TAPERED FLEX



CONSTRUCTION

Blade:
8Cr13MoV
Ti-Nitride
Bonded High
Carbon S.S.
Handle:
Textured,
Non-Slip Grip



FEATURES

- Flexible Blade
- Safety Guards
- Trigger Grip
- Lanyard Hole
- Synthetic Sheath

SPECS

Blade Length
7" (17.78 cm)
Overall Length
13" (33.02 cm)
Weight
5.7 oz.
UPC
794504877731



• ideal for MED & LG size fish •



• FLEX SCALE •



BB1-9F

9" FLEX



CONSTRUCTION

Blade:
8Cr13MoV
Ti-Nitride
Bonded High
Carbon S.S.
Handle:
Textured,
Non-Slip Grip



FEATURES

- Moderate Flex
- Safety Guards
- Trigger Grip
- Lanyard Hole
- Synthetic Sheath

SPECS

Blade Length
9" (22.86 cm)
Overall Length
15" (38.1 cm)
Weight
6.6 oz.
UPC
794504877830



• ideal for MED & LG size fish •



• FLEX SCALE •



BB1-9S

9" STIFF



CONSTRUCTION

Blade:
8Cr13MoV
Ti-Nitride
Bonded High
Carbon S.S.
Handle:
Textured,
Non-Slip Grip



FEATURES

- Rigid Structure
- Safety Guards
- Trigger Grip
- Lanyard Hole
- Synthetic Sheath

SPECS

Blade Length
9" (22.86 cm)
Overall Length
15" (38.1 cm)
Weight
7.6 oz.
UPC
606859308291



• ideal for MED & LG size fish •



• FLEX SCALE •



BB1-9TF

9" TAPERED FLEX



CONSTRUCTION

Blade:
8Cr13MoV
Ti-Nitride
Bonded High
Carbon S.S.
Handle:
Textured,
Non-Slip Grip



FEATURES

- Flexible Blade
- Safety Guards
- Trigger Grip
- Lanyard Hole
- Synthetic Sheath

SPECS

Blade Length
9" (22.86 cm)
Overall Length
15" (38.1 cm)
Weight
5.9 oz.
LPC
606850308444



• Ideal for MED & LG size fish •



• FLEX SCALE •



BB1-12F

12" FLEX



CONSTRUCTION

Blade:
8Cr13MoV
Ti-Nitride
Bonded High
Carbon S.S.
Handle:
Textured,
Non-Slip Grip



FEATURES

- Moderate Flex
- Safety Guards
- Trigger Grip
- Lanyard Hole
- Synthetic Sheath

SPECS

Blade Length
12" (30.48 cm)
Overall Length
18" (45.72 cm)
Weight
7 oz.
LPC
606850308437



• Ideal for LG size fish •



• FLEX SCALE •



1112553

9" SERRATED FLEX



CONSTRUCTION

Blade:
TiN-Coated
High Carbon
Stainless Steel
Full-Tang
Handle:
Textured,
Non-Slip Grip



FEATURES

- Moderate Flex
- Serrated Edges
- Safety Guards
- Trigger Grip
- Lanyard Hole
- Synthetic Sheath

SPECS

Blade Length
9" (22.86 cm)
Overall Length
15" (38.1 cm)
UPC
601120079910



• Ideal for MED & LG size fish •



• FLEX SCALE •



1982314



ATLUS™ KNIFE SHARPENER

CONSTRUCTION

Stone:
180 Grit,
400 Grit

Case:
Sticks to Surface
for Ultimate
Security When
Sharpening

FEATURES

- Non-Slip Grip Case
- 2 Locking Positions: 19°, 26°
- Manual
- Portable

SPECS

Locking System
19-26 Degrees

UPC
661120079859



• ideal for all knife sharpening needs •

BB1-ST-BP

10" SHARPENING STEEL



CONSTRUCTION

Steel:
8Cr13MoV
High Carbon S.S.
Hard Chromium
Plated

Handle:
Textured,
Non-Slip Grip

FEATURES

- Magnetic Steel
Attracts Metal
Fibers
- Safety Guards
- Trigger Grip
- Lanyard Hole
- Synthetic Sheath

SPECS

Steel Length
10" (25.4 cm)
Overall Length
16" (40.64 cm)
Weight
12 oz.
UPC
019962035418



• HOW-TO •

- Start with Edge of the Blade at Steel Base
- Drag Blade Down & Away from Yourself at a 20° Angle
- Repeat 5-10 Times and/or as Needed
- Wipe with Clean Cloth As Needed



SCHRADE[®]

2021 NEW PRODUCTS

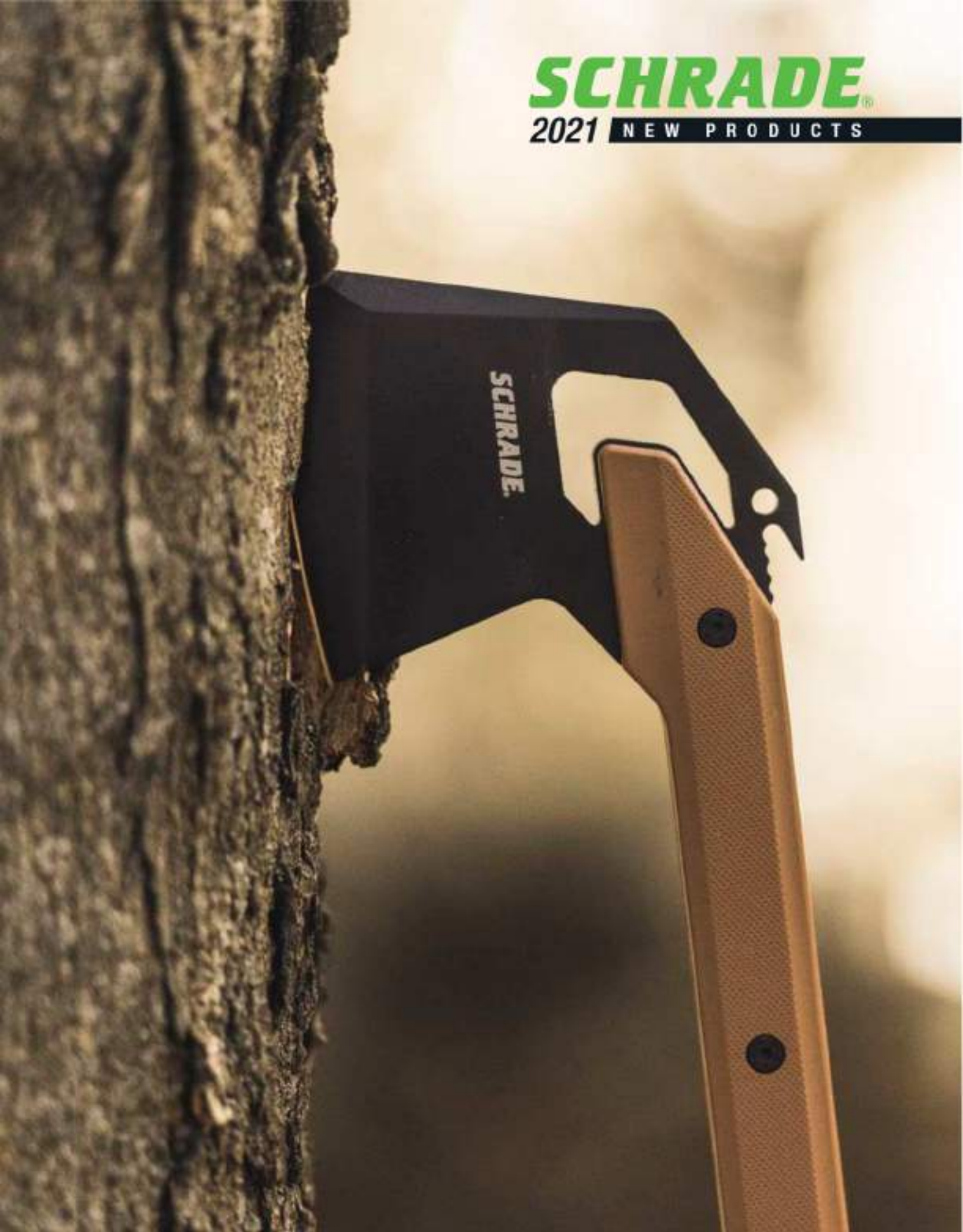

I-BEAM™

FIXED BLADE

- Black Oxide Modified Drop Point Blade
- FDE G10 Handle
- AUS-8 Stainless Steel
- Polyester Sheath Included

Item #: 1136029

UPC: 661120106418

Blister Size: TBD

Case Pack: 3



REGIME™

FIXED BLADE

- Powder Coated Gray Tanto Blade
- Black G10 Handle
- AUS-8 Stainless Steel
- Polyester Sheath Included

Item #: 1136036

UPC: 661120106432

Blister Size: TBD

Case Pack: 3



STEEL DRIVER™

FIXED BLADE

- Black Oxide Modified Drop Point Blade
- Black G10 Handle
- AUS-8 Stainless Steel
- Polyester Sheath Included

Item #: 1136030

UPC: 661120106425

Blister Size: TBD

Case Pack: 3



SENTIMENT™

FOLDING KNIFE

- Black Oxide Drop Point Blade
- Black G10 Handle
- AUS-8 Stainless Steel
- Ultra Glide Opening

Item #: 1136031 UPC: 661120106449

Blister Size: TBD Case Pack: 3



DIVERGENT™

FOLDING KNIFE

- Powder Coated Gray Drop Point Blade
- Black G10 Handle
- AUS-8 Stainless Steel
- Ultra Glide Opening

Item #: 1136032 UPC: 661120106456

Blister Size: TBD Case Pack: 3



KINETIC™

FOLDING KNIFE

- Clip Point Style Blade
- Black G10 Handle
- AUS-8 Stainless Steel
- Ultra Glide Opening

Item #: 1136039 UPC: 661120106784

Blister Size: TBD Case Pack: 3



FANATIC™ FOLDING KNIFE

- Black Oxide Drop Point Blade
- Black G10 Handle
- AUS-8 Stainless Steel
- Ultra Glide Opening

Item #: 1136034 UPC: 661120106463
Blister Size: TBD Case Pack: 3



TORSION™ FOLDING KNIFE

- Brushed Stainless Sheepfoot Blade
- Black G10 Handle
- AUS-8 Stainless Steel
- Ultra Glide Opening

Item #: 1136037 UPC: 661120106470
Blister Size: TBD Case Pack: 3



SCHRADE®



SCHRADE

RETURNING PRODUCTS

12" AXE

Blade Length
4.12" (10.47 cm)
Overall Length
12" (30.48 cm)

3CR13 STEEL BLADE, GLASS FIBER NYLON HANDLE

- Lightweight
- Sheath included
- Lanyard hole
- Black oxide blade



1121076 12" AXE BOX
UPC - 661120081494

1121077 12" AXE CLAM
UPC - 661120081500



19.5" AXE

Blade Length
5.5" (13.97 cm)
Overall Length
19.5" (49.53 cm)

3CR13 STEEL BLADE, GLASS FIBER NYLON HANDLE

- Lightweight
- Sheath included
- Lanyard hole
- Black oxide blade



1121078 19.5" AXE BOX
UPC - 661120081517

1121079 19.5" AXE CLAM
UPC - 661120081524



17" MACHETE

Blade Length
10.75" (27.31 cm)
Overall Length
17" (43.18 cm)

3CR13 STEEL BLADE, GLASS FIBER NYLON HANDLE

- Lightweight
- Lanyard hole
- Sheath included
- Black oxide blade



1121080 17" MACHETE BOX
UPC - 661120081531

1121081 17" MACHETE CLAM
UPC - 661120081548

3.3" ULTRA GLIDE®

Blade Length
3.3" (8.38 cm)
Overall Length
8" (20.32 cm)

3CR13 STEEL BLADE, CARBON FIBER & G10 SCALE HANDLE

- Finger flipper
- Dual thumb studs
- Pocket clip
- Black oxide blade



1121082 3.3" ULTRA GLIDE BOX
UPC - 661120081555

1121083 3.3" ULTRA GLIDE CLAM
UPC - 661120081562

3.5" ULTRA GLIDE®

Blade Length
3.5" (8.89 cm)
Overall Length
8" (20.32 cm)



3CR13 STEEL BLADE, G10 SCALE HANDLE

- Finger flipper
- Dual thumb studs
- Pocket clip
- Black oxide blade



1121084 3.5" ULTRA GLIDE BOX
UPC - 661120081579

1121085 3.5" ULTRA GLIDE CLAM
UPC - 661120081586

4" FIXED BLADE

Blade Length
4" (10.16 cm)
Overall Length
8.86" (22.5 cm)

3CR13 STEEL BLADE, GLASS FIBER NYLON HANDLE

- Lightweight
- Lanyard hole
- Sheath included
- Black oxide blade



1121086 4" FIXED BLADE BOX
UPC - 661120081593

1121087 4" FIXED BLADE CLAM
UPC - 661120081609

4.5" FIXED BLADE

Blade Length
4.5" (11.43 cm)
Overall Length
8.86" (22.5 cm)

3CR13 STEEL BLADE, GLASS FIBER NYLON HANDLE

- Lightweight
- Lanyard hole
- Sheath included
- Black oxide blade



1124284 4.5" FIXED BLADE BOX
UPC - 661120081616

1124285 4.5" FIXED BLADE CLAM
UPC - 661120081623

4" FIXED DROP POINT

Blade Length
4" (10.16 cm)
Overall Length
8.96" (22.5 cm)

9CR18MOV STEEL BLADE, INJECTION PP & TPR HANDLE

- Lightweight
- Lanyard hole
- Sheath included
- Black oxide blade



1124286 4" FIXED DROP POINT BOX
UPC - 661120081630

1124287 4" FIXED DROP POINT CLAM
UPC - 661120081647

3.25" ULTRA GLIDE[®]

Blade Length
3.25" (8.26 cm)
Overall Length
7.5" (28.8 cm)



9CR18MOV STEEL BLADE, GLASS FIBER NYLON HANDLE

- Liner lock
- Dual thumb studs
- Lanyard hole
- Stonewash finish blade



11.34"



1124290 3.25" ULTRA GLIDE BOX
UPC - 661120081678

1124291 3.25" ULTRA GLIDE CLAM
UPC - 661120081685

4.25" FIXED BLADE

Blade Length
4.25" (10.8 cm)
Overall Length
8.5" (21.59 cm)

3CR13 STEEL BLADE, GLASS FIBER NYLON HANDLE

- Lightweight
- Lanyard hole
- Hard polymer sheath included
- Black oxide blade



8.5"



1124288 4.25" FIXED BLADE BOX
UPC - 661120081654

1124289 4.25" FIXED BLADE CLAM
UPC - 661120081661

SHOVEL SAW COMBO

Shovel Length
6.5" (11.43 cm)

Shovel Overall Length
16.7" (42.42 cm)

Saw Blade Length
7.6" (19.3 cm)

Saw Overall Length
18.7" (47.5 cm)

3CR13 STEEL BLADE, ALUMINUM HANDLE

- Lightweight
- Lanyard hole
- Sheath included
- Black oxide blade



1124292

SHOVEL SAW COMBO BOX

LPC - 861120081892



QUALITY SINCE 1904

SHIZNIT™ SERIES

SHIZNIT™

ASSISTED OPENING

Blade Length
3.4" (8.7 cm)
Overall Length
7.7" (19.6 cm)
Weight
3.8 oz.



AUS-8 HIGH CARBON S.S. BLADE, ALUMINUM HANDLE

- Dual Thumb Knobs
- Liner Lock
- Safety Lock
- Finger Actuator
- Pocket Clip



7.7"

SCHA13B KUKRI POINT BLACK BLADE BLACK HANDLE BOX
UPC - 044358226103



4.46"

24/7® SERIES

24/7® SERIES

ASSISTED OPENING

Blade Length
3.2" (8.1 cm)
Overall Length
7.5" (19.1 cm)
Weight
4.9 oz.



AUS-8 STEEL BLADE, ALUMINUM HANDLE

- Dual Thumb Knobs
- Liner Lock
- Safety Lock
- Finger Actuator
- Pocket Clip



7.5"

SCHA8B CLIP POINT BLACK BLADE BLACK/GREY HANDLE BOX
UPC - 044358222877

SCHA8BS CLIP POINT SERRATED BLACK BLADE BLACK/GREY HANDLE BOX
UPC - 044358222884



Serrated Blade Option



4.4"

SHIZZLE® SERIES

SHIZZLE®

ASSISTED OPENING

Blade Length
3.4" (8.7 cm)
Overall Length
7.7" (19.4 cm)
Weight
4.4 oz.



AUS-8 HIGH CARBON S.S. BLADE, ALUMINUM HANDLE

- Dual Thumb Knobs
- Liner Lock
- Safety Lock
- Finger Actuator
- Repositionable Pocket Clip
(Tip-Up/Down & Left/Right Options)



SCHA11B DROP POINT BLACK BLADE BLACK HANDLE BOX

UPC - 044356224697

SCHA11B\$ DROP POINT SERRATED BLACK BLADE BLACK HANDLE BOX

UPC - 044356224703



Serrated Blade Option



SCHA7 SERIES

SCHA7 SERIES

ASSISTED OPENING

Blade Length
3.3" (8.4 cm)
Overall Length
7.6" (19.3 cm)
Weight
4.8 oz.



AUS-8 STEEL BLADE, COARSE POWDER COATED ALUMINUM HANDLE

- Dual Thumb Knobs
- Liner Lock
- Safety Lock
- Finger Actuator
- Pocket Clip



SCHA7GR CLIP POINT BLACK BLADE NEON GREEN HANDLE BOX

UPC - 044356221085



Neon Green Handle

SCHA7 SERIES ASSISTED OPENING

Blade Length
3.3" (8.4 cm)
Overall Length
7.6" (19.3 cm)
Weight
4.8 oz.



7.6"



Black Handle

4.3"

SCHA7B CLIP POINT BLACK BLADE BLACK HANDLE BOX
UPC - 044356220837

LAND SHARK® SERIES

LAND SHARK® ASSISTED OPENING

Blade Length
3" (7.6 cm)
Overall Length
7" (17.7 cm)
Weight
2.8 oz.



AUS-8 STEEL BLADE, ALUMINUM HANDLE

- ▶ Thumb Plate
- ▶ Liner Lock
- ▶ Safety Lock
- ▶ Finger Actuator
- ▶ Pocket Clip



7"



Grey Handle

4"

SCHA9 CLIP POINT GREY BLADE GREY HANDLE BOX
UPC - 044356223294

SCHA3BSCP

ASSISTED OPENING

Blade Length
2.9" (7.3 cm)
Overall Length
7.3" (18.5 cm)
Weight
4.9 oz.
UPC
044356218876

4034 S.S. BLADE, ALUMINUM HANDLE

- Thumb Plates
- Finger Actuator
- Liner Lock
- Pocket Clip
- Safety Lock



7.3"



4.4"

SCHA3CBS

ASSISTED OPENING

Blade Length
2.9" (7.3 cm)
Overall Length
7.3" (18.5 cm)
Weight
4.9 oz.
UPC
044356216777



colorshift



7.3"



Colorshift® Handle

4.4"

AUS-8 STEEL BLADE, ALUMINUM HANDLE

- Mode Selector Switch
- Dual Thumb Knobs
- Liner Lock
- Finger Actuator
- Pocket Clip

DUAL ASSIST OPENING

Blade Length
3.4" (8.7 cm)
Overall Length
8.1" (20.6 cm)
Weight
5.3 oz.



8.1"



4.67"



Dual-Sided Clip Placement



SCHA12B DROP POINT BLACK BLADE BLACK HANDLE BOX

UPC - 044356225793

SCHA12BS DROP POINT SERRATED BLACK BLADE BLACK HANDLE BOX

UPC - 044356225809



VIPER® SCHOTF3 SERIES

4034 S.S. BLADE, ALUMINUM HANDLE

- Blade Release
- Blade Slider
- Safety Lock
- Pocket Clip
- Glass Breaker



BLADE SLIDER

VIPER®

OTF ASSISTED OPENING

Blade Length
3.5" (8.8 cm)
Overall Length
8.8" (22.4 cm)
Weight
4.9 oz.



Black Blade

8.8"



ASSISTED
OPENING



Blade Slider



5.3"

SCHOTF3B STILETTO POINT BLACK BLADE BLACK HANDLE BOX

UPC - 044356214001 No Ship CA, NY, MA

SCHOTF3BS STILETTO POINT SERRATED BLACK BLADE BLACK HANDLE BOX

UPC - 044356214605 No Ship CA, NY, MA

SCHOTF3CB STILETTO POINT SCALLOPED BLACK BLADE BLACK HANDLE BOX

UPC - 044356222471 No Ship CA, NY, MA

SCHOTF3S STILETTO POINT SERRATED WHITE BLADE BLACK HANDLE BOX

UPC - 044356214599 No Ship CA, NY, MA

SCHOTF3C STILETTO POINT SCALLOPED WHITE BLADE BLACK HANDLE BOX

UPC - 044356222464 No Ship CA, NY, MA



Black Serrated Blade



Black Scalloped Blade



White Serrated Blade



White Scalloped Blade



VIPER® SCHOTF8 SERIES

VIPER®

OTF ASSISTED OPENING

Blade Length
3.4" (8.5 cm)
Overall Length
8.5" (21.6 cm)
Weight
4.4 oz.



AUS-8 STEEL BLADE, ALUMINUM HANDLE

- Blade Release
- Safety Lock
- Finger Actuator
- Blade Slider
- Pocket Clip
- Glass Breaker



8.5"

SCHOTF8TB TANTO POINT BLACK BLADE BLACK HANDLE BOX

UPC - 044356222624

SCHOTF8TBS TANTO POINT SERRATED BLACK BLADE BLACK HANDLE BOX

UPC - 044356222631

SCHOTF8B STILETTO POINT BLACK BLADE BLACK HANDLE BOX

UPC - 044356222600 No Ship CA, NY, MA

SCHOTF8BS STILETTO POINT DOUBLE SERRATED BLACK BLADE BLACK HANDLE BOX

UPC - 044356222617 No Ship CA, NY, MA



5.15"



TANTO Serrated Blade



Stiletto Blade



Stiletto Double Serrated Blade

VIPER®

OTF ASSISTED OPENING

Blade Length
3.8" (9.1 cm)
Overall Length
9.1" (23.1 cm)
Weight
6.2 oz.



AUS-8 STEEL BLADE, ALUMINUM HANDLE

- Blade Release
- Safety Lock
- Blade Slider
- Pocket Clip
- Glass Breaker



9.1"

SCHOTF7BS CLIP POINT SERRATED BLACK BLADE BLACK HANDLE BOX

UPC - 044356219846



5.5"



SCHSA3DBCP

SIDE ASSISTED OPENING

Blade Length

2.7" (6.3 cm)

Overall Length

6.2" (15.8 cm)

Weight

2.6 oz.

UPC

044356216883

**ASSISTED
OPENING**



4034 S.S. BLADE, ALUMINUM HANDLE

- » Blade Release
- » Punch Hole
- » Safety Lock
- » Pocket Clip



6.2"



3.65"





STRAP CUTTER

SCH911 SERIES

4034 S.S. BLADE
NYLON FIBER HANDLE

- Dual Thumb Knobs
- Safety/Liner Lock
- Strap Cutter
- Glass Breaker
- Oxygen Tank Wrench
- Finger Actuator
- Pocket Clip

SCH911

ASSISTED OPENING

Blade Length
3.4" (8.6 cm)
Overall Length
8.4" (21.3 cm)
Weight
5.6 oz.
UPC
044358202930



8.4"



5"



SCH911DBS

ASSISTED OPENING

Blade Length
3.5" (9.0 cm)
Overall Length
8.3" (21 cm)
Weight
5.6 oz.
UPC
044358205023



8.3"



5"



SCMF

SCHRADE® BALISONG MANILLA FOLDER® #10 Shop CA, NY, MA



D2 HIGH CARBON BLADE, S.S. HANDLE

Blade Length
4" (10.2 cm)
Overall Length
9" (22.8 cm)
Weight
7.9 oz.
UPC
044356229135



9"



4.6"



SC600T

FOLDING KNIFE

Blade Length
3.3" (8.3 cm)
Overall Length
7.8" (19.9 cm)
Weight
3.7 oz.
UPC
044356225892

4116 STEEL BLADE, ALUMINUM HANDLE

- » Push Button Lock
- » Glass Breaker
- » Safety Lock
- » Reversible Pocket Clip



SC60B

FOLDING KNIFE

Blade Length
3.3" (8.3 cm)
Overall Length
7.8" (19.9 cm)
Weight
3.7 oz.



- SC60B** DROP POINT BLACK BLADE BLACK HANDLE BOX
UPC - 044358202091
- SC60BS** DROP POINT SERRATED BLACK BLADE BLACK HANDLE BOX
UPC - 044358202107
- SC60BT** TANTO BLADE BLACK HANDLE BOX
UPC - 044358202114
- SC60BTS** TANTO SERRATED BLACK BLADE BLACK HANDLE BOX
UPC - 044358202121



SC60MB

FOLDING KNIFE

Blade Length
2.4" (6.1 cm)
Overall Length
6.1" (15.5 cm)
Weight
2.3 oz.
UPC
044356219372

4116 STEEL BLADE, ALUMINUM HANDLE

- » Push Button Lock
- » Safety Lock
- » Glass Breaker
- » Reversible Pocket Clip



SC90B

FOLDING KNIFE

AUS-8 HIGH CARBON S.S. BLADE, ALUMINUM HANDLE

- » Push Button Lock
- » Glass Breaker
- » Safety Lock
- » Reversible Pocket Clip

Blade Length
3.2" (8.0 cm)
Overall Length
7.8" (19.9 cm)
Weight
3.5 oz.



SC90B CLIP POINT BLACK BLADE BLACK HANDLE BOX

UPC - 044356226080

SC90BS CLIP POINT SERRATED BLACK BLADE BLACK HANDLE BOX

UPC - 044356226097



1084293

FOLDING KNIFE

**9Cr18MoV BEAD BLAST SATIN HIGH CARBON S.S. BLADE
ABS & KRATON W/ANODIZED ALUMINUM INSERT HANDLE**

- » Dual Thumbstuds
- » Liner Lock
- » Pocket Clip
- » Lanyard Hole



Blade Length
3.15" (8 cm)
Overall Length
7.28" (18.5 cm)
Weight
3.3 oz.

7.28"



4.25"

1084293 TANTO POINT BLADE RUBBERIZED HANDLE BOX

UPC - 661120413547

1084294 TANTO POINT BLADE RUBBERIZED HANDLE CLAM

UPC - 661120413554

1084289

FOLDING KNIFE

9Cr18MoV BEAD BLAST SATIN HIGH CARBON S.S. BLADE, ANODIZED ALUMINUM W/RUBBER INLAY HANDLE

- » Dual Thumbstuds
- » Liner Lock
- » Pocket Clip
- » Lanyard Hole

Blade Length
3.35" (8.5 cm)
Overall Length
7.68" (19.5 cm)
Weight
4 oz.



7.68"



4.53"

1084289 CLIP POINT BLADE GREY/BLACK HANDLE BOX

UPC - 661120413509

1084290 CLIP POINT BLADE GREY/BLACK HANDLE CLAM

UPC - 661120413516

SCH107

FOLDING KNIFE

8Cr13MoV HIGH CARBON S.S. BLADE, TEXTURED G-10 HANDLE

- Dual Thumb Studs
- Liner Lock
- Pocket Clip

Blade Length
2.5" (6.3 cm)
Overall Length
6" (15.2 cm)
Weight
2.1 oz
UPC
044358218870



SCH224

FOLDING KNIFE

8Cr13MoV TITANIUM COATED HIGH CARBON S.S. BLADE, ALUMINUM HANDLE

- Thumb Stud
- Liner Lock
- Pocket Clip

Blade Length
2.8" (7 cm)
Overall Length
6.6" (16.8 cm)
Weight
2.9 oz.



SCH224

DROP POINT BLADE ALUMINUM HANDLE BOX

UPC - 044358227209

SCH107ALBK

FOLDING KNIFE

8Cr13MoV HIGH CARBON S.S. BLADE, ALUMINUM HANDLE

- » Dual Thumb Knobs
- » Liner Lock
- » Pocket Clip

Blade Length
2.5" (6.3 cm)

Overall Length
6" (15.2 cm)

Weight
1.8 oz.

UPC
044356223317



6"



3.5"

SCH107ALOR

UPC
044356223324



SCH501

FOLDING KNIFE

9Cr18MoV STONEWASHED HIGH CARBON S.S. BLADE G-10 W/ALUMINUM HANDLE

- » Dual Thumb Studs
- » Liner Lock
- » Glass Breaker
- » Index Flipper
- » Pocket Clip

Blade Length
3.2" (8.1 cm)

Overall Length
7.8" (19.8 cm)

Weight
5.1 oz.



7.8"



Serrated Blade Option



4.6"

SCH501 DROP POINT BLADE MOTTLED/BLACK HANDLE BOX

UPC - 044358220996

SCH501S DROP POINT SERRATED BLADE MOTTLED/BLACK HANDLE BOX

UPC - 044356219631

SCH501SCP DROP POINT SERRATED BLADE MOTTLED/BLACK HANDLE CLAM

UPC - 044358219648

POCKET PROTECTOR®

SCH222BK

POCKET PROTECTOR®

8Cr13MoV HIGH CARBON S.S. BLADE, ALUMINUM & S.S. HANDLE

- » Dual Thumb Studs
- » Frame Lock
- » Carabiner Clip
- » Money/Pocket Clip

Blade Length

2.6" (6.5 cm)

Overall Length

5.8" (14.7 cm)

Weight

1.4 oz.

SCH222BK DROP POINT BLADE BLACK HANDLE BOX

UPC - 044356225519

SCH222BKCP DROP POINT BLADE BLACK HANDLE CLAM

UPC - 044356226394



(Black Handle)

5.8"



3.25"

CLIP INCLUDED

SCH002

FOLDING KNIFE

8Cr13MoV HIGH CARBON S.S. BLADE, ABS & TPR HANDLE

- » Dual Thumb Studs
- » Index Flipper
- » Liner Lock
- » Pocket Clip

Blade Length

3.4" (8.5 cm)

Overall Length

7.9" (19.9 cm)

Weight

3.7 oz.



7.9"



4.55"

SCH002 DROP POINT BLADE BLACK HANDLE BOX

UPC - 044356225663

SCH002CP DROP POINT BLADE BLACK HANDLE CLAM

UPC - 044356228534

SCH109

FOLDING KNIFE

9Cr18MoV HIGH CARBON S.S. BLADE, TEXTURED G-10 HANDLE

- » Dual Thumb Studs
- » Liner Lock
- » Index Flipper
- » Pocket Clip

Blade Length

3.5" (8.9 cm)

Overall Length

8.2" (20.8 cm)

Weight

5.3 oz.

UPC

044356222211



DOUBLE LOCKBACK

SCH0050LD

SCHRADE® DOUBLE LOCKBACK

8Cr13MoV HIGH CARBON S.S. BLADE, RUBBER COATED ALUMINUM HANDLE

- » Thumb Holes
- » Double Lockback
- » Pocket Clip

Blade Length

2.9" (7.3 cm)

Overall Length

9.5" (24.0 cm)

Weight

3.3 oz.

UPC

044356229036



ULTRA GLIDE® SERIES

BALL BEARING PIVOT PIN TECH ALLOWS FOR ULTRA SMOOTH OPENING



1084281

ULTRA GLIDE® FOLDING KNIFE



9Cr18MoV TITANIUM COATED HIGH CARBON S.S. BLADE
TI-NITRIDE STEEL HANDLE

- ▶ Carbon Fiber Slab on One Side
- ▶ Finger Flipper
- ▶ Frame Lock
- ▶ Pocket Clip
- ▶ Lanyard Hole

Blade Length
2.76" (7 cm)
Overall Length
6.5" (16.5 cm)
Weight
2.3 oz.



6.5"



3.94"

1084281 DROP POINT BLADE CARBON FIBER HANDLE BOX
UPC - 661120413424

SCH305

ULTRA GLIDE® FOLDING KNIFE

9Cr18MoV HIGH CARBON S.S. BLADE
S.S. W/G-10 HANDLE

- ▶ Dual Thumb Studs
- ▶ Liner Lock
- ▶ Pocket Clip

Blade Length
3.5" (8.9 cm)
Overall Length
8.2" (20.8 cm)
Weight
5.3 oz.



8.2"



4.75"

SCH305 DROP POINT BLADE ALUMINUM/BLACK HANDLE BOX
UPC - 044358228992

SCH306

ULTRA GLIDE® FOLDING KNIFE

9Cr18MoV HIGH CARBON S.S. BLADE
ALUMINUM HANDLE

- » Dual Thumb Studs
- » Liner Lock
- » Pocket Clip

Blade Length
3.5" (8.8 cm)
Overall Length
8.1" (20.7 cm)
Weight
5.2 oz.



8.1"



4.74"

SCH306 CLIP POINT BLADE ALUMINUM HANDLE CLAM
UPC - 044356229074

1084292

ULTRA GLIDE® FOLDING KNIFE

9Cr18MoV TITANIUM COATED HIGH CARBON S.S. BLADE
TI-NITRIDE STEEL W/CARBON FIBER INLAY HANDLE

- » Thumbstuds
- » Liner Lock
- » Pocket Clip
- » Lanyard Hole

Blade Length
2.95" (7.5 cm)
Overall Length
6.5" (16.5 cm)
Weight
2.4 oz.



6.5"



3.94"

1084292 DROP POINT BLADE CARBON FIBER HANDLE CLAM
UPC - 681120413530

1084279

ULTRA GLIDE® FOLDING KNIFE



9Cr18MoV TITANIUM COATED HIGH CARBON S.S. BLADE
RUBBERIZED ALUMINUM HANDLE

- » Finger Flipper
- » Liner Lock
- » Pocket Clip
- » Lanyard Hole

Blade Length
3.54" (9 cm)
Overall Length
8" (20.5 cm)
Weight
4.2 oz.



8"



4.72"

1084279 CLIP POINT BLADE RUBBERIZED HANDLE BOX

UPC - 661120413400

1084280 CLIP POINT BLADE RUBBERIZED HANDLE CLAM

UPC - 661120413417

1084283

ULTRA GLIDE® FOLDING KNIFE



9Cr18MoV TITANIUM COATED HIGH CARBON S.S. BLADE
TI-NITRIDE STEEL MACHINED W/G10 INLAY HANDLE

- » Thumb Hole
- » Finger Flipper
- » Frame Lock
- » Pocket Clip

Blade Length
2.76" (7 cm)
Overall Length
6.5" (16.5 cm)
Weight
2.3 oz.



6.5"



3.74"

1084283 CLIP POINT BLADE CAGE HANDLE BOX

UPC - 661120413448

1084284 CLIP POINT BLADE CAGE HANDLE CLAM

UPC - 661120413455

SCHRADE | FOLDING KNIVES

SCH301

FOLDING KNIFE

9Cr18MoV TITANIUM COATED HIGH CARBON S.S. BLADE
TITANIUM COATED S.S. HANDLE

- » Dual Thumb Knobs
- » Frame Lock
- » Index Flipper
- » Pocket Clip

Blade Length
3.7" (9.3 cm)

Overall Length
8.6" (21.8 cm)

Weight
10.6 oz.

UPC
044356217361



8.6"



4.9"

SCH303M

FOLDING KNIFE

9Cr18MoV TITANIUM COATED HIGH CARBON S.S. BLADE
TITANIUM COATED S.S. HANDLE

- » Dual Thumb Knobs
- » Frame Lock
- » Pocket Clip

Blade Length
2.6" (6.6 cm)

Overall Length
6" (15.2 cm)

Weight
2.5 oz.

UPC
044356219693



6"



3.4"

SCH304

FOLDING KNIFE

9Cr18MoV TITANIUM COATED HIGH CARBON S.S. BLADE
TITANIUM COATED S.S. HANDLE

- » Dual Thumb Knobs
- » Frame Lock
- » Pocket Clip

Blade Length
3.7" (9.3 cm)

Overall Length
8.5" (21.6 cm)

Weight
9.7 oz.

UPC
044356217422



8.5"



4.8"

SCHF1 & SCHF2

EXTREME SURVIVAL™

SAE-1070 HIGH CARBON STEEL BLADE & HANDLE

- Waterproof Hollow Handle
- Interchangeable Magnetic
- Tipped Tool
- Ballistic Sheath

Blade Length
7.5" (19 cm)

Overall Length
12.7" (32.3 cm)

Weight
1 lb. 1.8 oz.



SCHF1 DROP POINT GREY SERRATED BLADE GREY HANDLE BOX

UPC - 044356202320

SCHF2 BOWIE POINT GREY SERRATED BLADE GREY HANDLE BOX

UPC - 044356202336



Bowie Blade



Ballistic Sheath

SCHF21

EXTREME SURVIVAL™

SAE-1070 HIGH CARBON STEEL BLADE & HANDLE

- Glass Breaker
- Waterproof Hollow Handle
- Glass-Filled Nylon Boot/Belt Sheath

Blade Length
4.5" (11.4 cm)

Overall Length
9" (22.8 cm)

Weight
5.1 oz.

UPC
044356219518

No Ship CA, NY, MA.



WATERPROOF HOLLOW HANDLE
Accessories Not Included



SCHF3H

EXTREME SURVIVAL™

**8Cr13MoV HIGH CARBON S.S. BLADE
MICARTA HANDLE**

- Full Tang
- Ballistic Sheath

Blade Length
6.4" (16.2 cm)

Overall Length
12" (30.4 cm)

Weight
1 lb. 6 oz.

UPC
044356207393



SCHF55LM

FIXED BLADE

1095 HIGH CARBON STEEL BLADE, MICARTA HANDLE

- Full Tang
- Thermoplastic Belt Sheath

Blade Length
4.4" (11.1 cm)

Overall Length
9.2" (23.3 cm)

Weight
9.3 oz.

UPC
044356228619



SCHF55L

FIXED BLADE

1095 HIGH CARBON STEEL BLADE, TPE HANDLE

- Full Tang
- Polyester Belt Sheath

Blade Length
4.4" (11.1 cm)

Overall Length
9.1" (23.2 cm)

Weight
8.4 oz.

UPC
044356227674



SCHF16

NECK KNIFE

9Cr18MoV HIGH CARBON S.S. BLADE, G-10 HANDLE

- Full Tang Neck Knife
- Lanyard Hole
- Thermoplastic Sheath

Blade Length
3.1" (7.8 cm)
Overall Length
7" (17.7 cm)
Weight
4.6 oz.
UPC
044358217460



SCHF46

NECK KNIFE

9Cr18MoV HIGH CARBON S.S. BLADE

- Full Tang Neck Knife
- 550 Paracord Wrapped Handle
- Nylon Fiber Neck Sheath

Blade Length
2.4" (6.2 cm)
Overall Length
8" (15.2 cm)
Weight
1.9 oz.
UPC
044356225212



SCH406K

NECK KNIFE

8Cr13MoV HIGH CARBON S.S. BLADE

- Full Tang Neck Knife
- 550 Paracord Wrapped Handle
- Nylon Fiber Neck Sheath

Blade Length
2.3" (5.8 cm)
Overall Length
5.2" (13.2 cm)
Weight
1.9 oz.
UPC
044356224000



SCHF61**FIXED BLADE****8Cr13MoV HIGH CARBON S.S. BLADE
MICARTA HANDLE**

- Full Tang
- Ballistic Belt Sheath

Blade Length
4.1" (10.5 cm)
Overall Length
8.7" (22.1 cm)
Weight
6.9 oz.



8.7"

SCHF61CP DROP POINT GREY BLADE MICARTA HANDLE CLAM PACK
UPC - 044356227971

**SCHF36M****FRONTIER®****8Cr13MoV POWDER COATED HIGH CARBON S.S. BLADE
MICARTA HANDLE**

- Full Tang
- Polyester Belt Sheath

Blade Length
5" (12.8 cm)
Overall Length
10.4" (26.4 cm)
Weight
13.4 oz.
UPC
044356222914



10.4"

Ferro Rod &
Sharpening Stone
Included

**SCHF37M****FRONTIER®****8Cr13MoV POWDER COATED HIGH CARBON S.S. BLADE
MICARTA HANDLE**

- Full Tang
- Polyester Belt Sheath

Blade Length
7" (17.8 cm)
Overall Length
12.4" (31.4 cm)
Weight
15.9 oz.
UPC
044356222921



12.4"

Ferro Rod &
Sharpening Stone
Included



SCHF36

FRONTIER®

Blade Length
5" (12.8 cm)
Overall Length
10.4" (26.4 cm)
Weight
12.3 oz.



**POWDER COATED 1095 HIGH CARBON BLADE
TPE HANDLE**

- Full Tang
- Polyester Belt Sheath

10.4"



Ferro Rod &
Sharpening Stone
Included

SCHF36 DROP POINT BLACK BLADE BLACK HANDLE BOX

UPC - 044358222556

SCHF36CP DROP POINT BLACK BLADE BLACK HANDLE CLAM

UPC - 044358222557

SCHF37

FRONTIER®

Blade Length
7" (17.8 cm)
Overall Length
12.4" (31.4 cm)
Weight
14.5 oz.
UPC
044358222563



12.4"



Ferro Rod &
Sharpening Stone
Included

SCHF38

FRONTIER®

Blade Length
5.8" (14.7 cm)
Overall Length
11.2" (28.3 cm)
Weight
13.4 oz.
UPC
044358222570



11.2"



Ferro Rod &
Sharpening Stone
Included

SCHF51M**FRONTIER®****1095 HIGH CARBON STEEL BLADE
MICARTA HANDLE**

Blade Length
5.1" (12.8 cm)
Overall Length
10.9" (27.6 cm)
Weight
14.8 oz.
UPC
044356225748



10.9"

Ferro Rod &
Sharpening Stone
Included

**SCHF52M****FRONTIER®****1095 HIGH CARBON STEEL BLADE
MICARTA HANDLE**

Blade Length
7" (17.9 cm)
Overall Length
13" (33.0 cm)
Weight
1 lb. 1.4 oz.
UPC
044350225755



13"

Ferro Rod &
Sharpening Stone
Included

**SCHF51****FRONTIER®****1095 HIGH CARBON STEEL BLADE
TPE HANDLE**

Blade Length
5.1" (12.8 cm)
Overall Length
10.9" (27.6 cm)
Weight
13.5 oz.
UPC
044356225182



10.9"

Ferro Rod &
Sharpening Stone
Included

**SCHF52****FRONTIER®****1095 HIGH CARBON STEEL BLADE
TPE HANDLE**

Blade Length
7" (17.9 cm)
Overall Length
13" (33.0 cm)
Weight
1 lb.
UPC
044356225199



13"

Ferro Rod &
Sharpening Stone
Included



SCHF55**FRONTIER®****1095 HIGH CARBON BLADE
GRIVORY HANDLE**

- Full Tang
- Leather Sheath

Blade Length
3.8" (9.0 cm)
Overall Length
7.8" (19.4 cm)
Weight
6 oz.
UPC
044356226424

**SCHF26****EXTREME SURVIVAL™****8Cr13MoV HIGH CARBON S.S. BLADE
TPE HANDLE**

- Full Tang
- Polyester Belt Sheath

Blade Length
5.4" (13.7 cm)
Overall Length
10.8" (27.4 cm)
Weight
13.6 oz.

**SCHF26 KUKRI POINT BLACK BLADE BLACK HANDLE BOX**

UPC - 044356220002

SCHF26CP KUKRI POINT BLACK BLADE BLACK HANDLE CLAM

UPC - 044356219990

**SCHF9****EXTREME SURVIVAL™****1095 HIGH CARBON STEEL BLADE
TPE HANDLE**

- Full Tang
- Ballistic Sheath

Blade Length
6.4" (16.3 cm)
Overall Length
12.1" (30.7 cm)
Weight
15.7 oz.

**SCHF9 KUKRI POINT GREY BLADE BLACK HANDLE BOX**

UPC - 044356207201

SCHF9CP KUKRI POINT GREY BLADE BLACK HANDLE CLAM

UPC - 044356216913



SCHF57

FIXED BLADE

65MN HIGH CARBON STEEL BLADE
G-10 HANDLE

- Full Tang
- Thermoplastic Bell Sheath (Compatible w/FR4 Removable Ferro Rod Attachment)

Blade Length
2.6" (6.7 cm)
Overall Length
6.3" (15.9 cm)
Weight
4 oz
UPC
044356227285



SCHF59

FIXED BLADE

65MN HIGH CARBON STEEL BLADE
G-10 HANDLE

- Full Tang
- Thermoplastic Bell Sheath (Compatible w/FR4 Removable Ferro Rod Attachment)

Blade Length
3.8" (9.7 cm)
Overall Length
8.4" (21.3 cm)
Weight
6.2 oz
UPC
044356227308



Removable Ferro Rod Attachment w/ Ferro Rod SOLD SEPARATELY



FERRO ROD ATTACHMENT

FR4 (Sold Separately) UPC - 044356227760

SCHF20

FIXED BLADE

8Cr13MoV HIGH CARBON S.S. BLADE

TPE HANDLE

- Full Tang
- Thermoplastic Sheath

Blade Length
4.9" (12.5 cm)
Overall Length
9.7" (24.6 cm)
Weight
6.3 oz
UPC
044356222501



SCHRADE® WATER RAT® SERIES

WR3

SCHRADE WATER RAT®

7Cr17MoV HIGH CARBON S.S. BLADE

PHOSPHORESCENT TPR HANDLE

- Full Tang
- Lanyard Hole
- Line Cutter
- PP Vest/Belt/Leg Sheath w/Open Drain Hole

Blade Length
4.7" (11.9 cm)
Overall Length
9.4" (23.8 cm)
Weight
4.4 oz
UPC
044356220583
No Ship CA, NY, MA



Vest Attachment Included



SCHF31

FIXED BLADE

8Cr13MoV HIGH CARBON S.S. BLADE
TPE HANDLE

- Full Tang
- Thermoplastic Sheath

Blade Length
4.5" (11.4 cm)
Overall Length
9.7" (24.7 cm)
Weight
7.6 oz.



SCHF31 DROP POINT GREY BLADE BLACK HANDLE BOX

UPC - 044356224376

SCHF31S DROP POINT SERRATED GREY BLADE BLACK HANDLE BOX

UPC - 044356224949



Serrated Blade Option



SCHF66

FIXED BLADE

7Cr17MoV HIGH CARBON S.S. BLADE
TPR HANDLE

- Full Tang
- Polyester Belt Sheath

Blade Length
2.9" (7.4 cm)
Overall Length
6.4" (16.3 cm)
Weight
3.2 oz.
UPC
044356229913



SCHF66 DROP POINT GREY BLADE BLACK HANDLE BOX

UPC - 044356229913

SCHF66CP DROP POINT GREY BLADE BLACK HANDLE CLAM

UPC - 044356229920



8Cr13MoV TITANIUM COATED HIGH CARBON S.S. BLADE
TPE HANDLE

SCHF28

LITTLE RICKY®

Blade Length
7.9" (20.2 cm)
Overall Length
14.1" (35.7 cm)
Weight
1 lb. 4.8 oz.
UPC
044356222235

- Full Targ
- Thermoplastic Belt Sheath



SCHF45

LEROY®

Blade Length
10.4" (26.3 cm)
Overall Length
16.5" (41.9 cm)
Weight
1 lb. 7.6 oz.
UPC
044356224796



SCHF48

JETHRO®

Blade Length
11.9" (30.2 cm)
Overall Length
18" (45.8 cm)
Weight
1 lb. 9.9 oz.
UPC
044356225205



SCHF27

FIXED BLADE

Blade Length	6.6" (16.7 cm)	Weight	9.9 oz.
Overall Length	11.5" (29.2 cm)	LPC	044356221160

8Cr13MoV TITANIUM COATED HIGH CARBON S.S. BLADE TPE HANDLE

- Full Tang
- Pry Tool Locking Pin/Lanyard
- Multiple Carry Option Nylon Filled Glass Fiber Sheath



STAINLESS STEEL TITANIUM COATED PRY TOOL

- 4.5" (11.4 cm) Overall Length
- Flat Head Screwdriver
- Strap Cutter
- Bottle Opener
- 1/4" Hex Wrench
- Wrench Driver



SCHF55M

MINI NECK KNIFE

7Cr17MoV HIGH CARBON S.S. BLADE

- Full Tang Neck Knife
- Lanyard Hole
- Bottle Opener
- Neck Sheath w/Breakaway Chain

Blade Length
2.1" (5.2 cm)
Overall Length
4.3" (11.0 cm)
Weight
0.7 oz.
UPC
044356224505

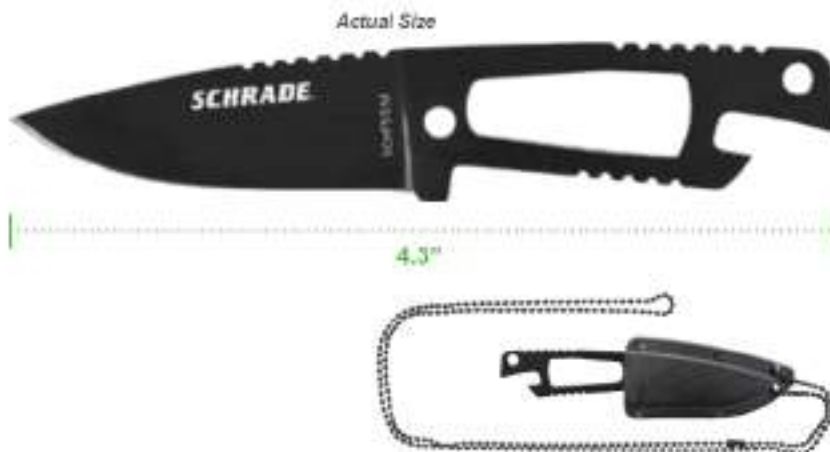

SCH110

FOLDING KARAMBIT

9Cr18MoV HIGH CARBON S.S. BLADE

G-10 HANDLE

- Dual Thumb Studs
- Liner Lock
- Pocket Clip (Additional Clip for Tip-Up Carry)

Blade Length
3.2" (8.0 cm)
Overall Length
7.8" (19.7 cm)
Weight
6.3 oz.
UPC
044356222259



Tip-Down Carry



Tip-Up Carry



SCH111**KARAMBIT NECK KNIFE**

Designed by Joshua Waggoner

9Cr18MoV HIGH CARBON

S.S. BLADE

- Full Tang Neck Knife
- Thermoplastic Sheath

Blade Length

3" (7.5 cm)

Overall Length

6.3" (16.1 cm)

Weight

2.3 oz.

UPC

044356228431

**SCH112****SHASTA MC'NASTY®**

8Cr13MoV HIGH CARBON S.S. BLADE

TPE HANDLE

- Full Tang
- Dual Edge Blade
- Thermoplastic Sheath

Blade Length

5.2" (13.2 cm)

Overall Length

8.4" (21.3 cm)

Weight

8.2 oz.

UPC

044356228448

No Shp CA, NY, MA



SCHF54

PUSH DAGGER

**8Cr13MoV HIGH CARBON S.S. BLADE
TPE HANDLE**

- Full Tang
- Multi-Carry Option Nylon Fiber Sheath

Blade Length
3.2" (8.2 cm)
Overall Length
6.5" (16.4 cm)
Weight
2.7 oz.
UPC
044358226387
No Ship CA, NY, MA



Multi-Carry Option Nylon Fiber Sheath



SCHF50

KEYCHAIN DAGGER

9Cr16MoV HIGH CARBON S.S. BLADE, TPE HANDLE

- Fully Serrated/Fine Edge
Spear Point Blade
- T-Handle w/Palm Jimping
- ABS Neck Sheath
w/Carabiner Clip

Blade Length
1.3" (3.2 cm)
Overall Length
2.8" (7.0 cm)
Weight
0.5 oz.
UPC
044358225137
No Ship CA, NY, MA



Actual Size

SCHCC1

CREDIT CARD KNIFE

8Cr13MoV HIGH CARBON S.S. BLADE

- Full Tang
- Thermoplastic Belt Sheath/
Money Clip

Blade Length
1.9" (4.8 cm)

Overall Length
3.6" (9.1 cm)

Weight
1 oz.

UPC
044356226240

SCHCC1CP CLAM

UPC 044356230520



Actual Size

SCHF19

SMALL BOOT KNIFE

7Cr17MoV HIGH CARBON S.S. BLADE

TPE HANDLE

- Lanyard Hole
- Leather Sheath w/Belt & Boot Clip

Blade Length
3.6" (9.1 cm)

Overall Length
7" (17.7 cm)

Weight
2.1 oz.

UPC
044356219464

No Ship CA, NY, MA



7"



SCHF44LS

NEEDLE® BOOT KNIFE

Blade Length
7.6" (19.4 cm)

Overall Length
12.7" (32.2 cm)

Weight
5.1 oz

UPC
044356224840

No Ship CA, NY, MA



12.7"



**SCHF13M****MINI NECK KNIFE****8Cr13MoV STONEWASH HIGH CARBON S.S. BLADE
G-10 HANDLE**

- Full Tang
- Lanyard Hole
- Kydex® Neck Sheath w/Breakaway Chain

Blade Length
2.1" (5.2 cm)
Overall Length
4.7" (12.0 cm)
Weight
1.4 oz.
UPC
044356224420



4.7"

**SCHF13****FIXED BLADE****8Cr13MoV STONEWASH HIGH CARBON S.S. BLADE
G-10 HANDLE**

- Full Tang
- Lanyard Hole
- Multi-Carry Option
Kydex® Belt Sheath

Blade Length
3.7" (9.4 cm)
Overall Length
8.5" (21.6 cm)
Weight
7.4 oz.
UPC
044356217217



8.5"



SCHF14

FIXED BLADE

Blade Length
3.4" (8.6 cm)
Overall Length
7.9" (20.0 cm)
Weight
5.6 oz



7.9"

8Cr13MoV STONWASH HIGH CARBON S.S. BLADE
G-10 HANDLE

- Full Tang
- Multi-Carry Option Kydex® Sheath

SCHF14 DROP POINT STONWASHED BLADE BLACK HANDLE BOX

UPC - 044356217224

SCHF14CP DROP POINT STONWASHED BLADE BLACK HANDLE CLAM

UPC - 044356217866



SCHF15

FIXED BLADE

Blade Length
3.4" (8.6 cm)
Overall Length
7.9" (20.0 cm)
Weight
6 oz
UPC
044356217231



7.9"



SCHF20

FIXED BLADE

8CR13MOV STONWASH HIGH CARBON S.S. BLADE
G-10 HANDLE

- Full Tang
- Multi-Carry Option
Kydex® Belt Sheath

Blade Length
4.4" (11.2 cm)
Overall Length
8.5" (21.6 cm)
Weight
5.5 oz
UPC
044356219495
No Ship CA, NY, MA



8.5"



SCHBOLO

BOLO FIXED BLADE

STAINLESS STEEL TITANIUM COATED S.S. BLADE
SAFE-T-GRIP® HANDLE

- » Lanyard Hole
- » Polyester Sheath w/Removable Storage Pouch Shoulder Strap/ Leg Strap/Belt Loop

Blade Length
14" (35.5 cm)
Overall Length
20.2" (51.2 cm)
Weight
1 lb. 10.8 oz.
UPC
044356210814



20.2"

Ferro Rod & Sharpening Stone Included



SCHMBSCP

PRISCILLA BRUSH SWORD

Designed by Joshua Waggoner

STAINLESS STEEL POWDER COATED BLADE
TPE HANDLE

- » Full Tang
- » Thermoplastic Sheath w/Shoulder Strap

Blade Length
16.1" (40.8 cm)
Overall Length
22.6" (57.5 cm)
Weight
19.8 oz.
UPC
044356229009



Only Available in Clam Pack



22.6"



SCHPRICP

PARANG MACHETE

STAINLESS STEEL BLADE
TPE HANDLE

- » Full Tang
- » Polyester Sheath w/Removable Shoulder Strap/Leg Strap/Belt Loop

Blade Length
13.7" (34.8 cm)
Overall Length
19.6" (49.8 cm)
Weight
21.3 oz.
UPC
044356220732



Only Available in Clam Pack



19.6"



SCHKM1

KUKRI MACHETE

STAINLESS STEEL POWDER COATED BLADE
SAFE-T-GRIP® HANDLE

- » Ferro Rod
- » Sharpening Stone
- » Lanyard Hole
- » Polyester Sheath with Removable Storage Pouch/Shoulder Strap/Leg Strap/Belt Loop

Blade Length
13.3" (33.8 cm)
Overall Length
19.7" (50.0 cm)
Weight
1 lb. 6.6 oz.



SCHKM1 KUKRI BLACK BLADE BLACK HANDLE BOX
UPC - 044358220545
SCHKM1CP KUKRI BLACK BLADE BLACK HANDLE CLAM
UPC - 044358220590

Ferro Rod &
Sharpening Stone
Included



SCHGKI

GURKHA KUKRI MACHETE

STAINLESS STEEL BLADE
TPE HANDLE

- » Lanyard Hole
- » Polyester Sheath w/Removable Shoulder Strap/ Leg Strap/Belt Loop

Blade Length
12.8" (32.5 cm)
Overall Length
18.3" (46.5 cm)
Weight
15.9 oz.
UPC
044358225229



SCMACH1CP MACHETE

STAINLESS STEEL BLADE

TPR HANDLE

- ✦ Full Tang
- ✦ Lanyard Hole
- ✦ Polyester Belt Sheath

Blade Length
12" (30.5 cm)

Overall Length
18.3" (46.4 cm)

Weight
13.2 oz.

UPC
044356224987

Only Available in Clam Pack



SCMACH2CP MACHETE

STAINLESS STEEL BLADE

TPR HANDLE

- ✦ Full Tang
- ✦ Lanyard Hole
- ✦ Polyester Belt Sheath

Blade Length
14.9" (37.7 cm)

Overall Length
20.9" (53.1 cm)

Weight
15.3 oz.

UPC
044356224994

Only Available in Clam Pack



SCHF64CP FROE FIXED BLADE

1070 HIGH CARBON STEEL BLADE

TPE HANDLE

- ✦ Full Tang
- ✦ Polyester Belt Sheath w/Leg Strap

Blade Length
8.5" (21.6 cm)

Overall Length
14.7" (37.4 cm)

Weight
15.6 oz.

UPC
044356229043

Only Available in Clam Pack



1084299

OUTDOOR KIT

STEEL WITH WRAPPED TEXTURED SILICONE HANDLES

- » Interchangeable Tool System
- » INCLUDES: Saw Blade, Pick, Axe, Shovel
- » Saw, Pick, Axe and Shovel Handles Expand from 9"-27"
- » Steel Handles Wrapped in Textured Silicone
- » Polyester Case
- » Safety Lock Icon

Weight
3 lb. 8.3 oz.
UPC
661120413608



SCAXE9CP

AXE/SAW

Blade Length
3.3" (8.3 cm)
Overall Length
18" (45.9 cm)
Weight
2 lb. 1.3 oz.
UPC
044356224246
Only Available
in Clam Pack

STAINLESS STEEL TITANIUM COATED BLADE GLASS FIBER FILLED PA & TPR HANDLE

- » 12.5" Fully Extending Saw Blade (Stores Inside Handle)
- » Polyester Belt Sheath

18"



SCAXE2L

LARGE SURVIVAL AXE

Blade Length
4.2" (10.6 cm)
Overall Length
15.7" (39.9 cm)
Weight
1 lb. 15 oz.

STAINLESS STEEL TITANIUM COATED BLADE GLASS FIBER FILLED PA & TPR RUBBER MATERIAL COLD-RESISTANT FLEXIBILIZER HANDLE

- » Dual Grit Round Disc Sharpening Stone
- » Ferro Rod (Stores in Shaft)
- » Polyester Belt Sheath

15.7"



SCAXE2L

LARGE AXE BLACK HANDLE BOX

UPC - 044356220941

SCAXE2LCP

LARGE AXE BLACK HANDLE CLAM

UPC - 044356220958

SCAXE2

SCAXE2 SERIES

STAINLESS STEEL TITANIUM COATED BLADE
GLASS FIBER FILLED PA & TPR RUBBER MATERIAL
COLD-RESISTANT FLEXIBILIZER HANDLE

- » Ferro Rod (Stores in Shaft)
- » Thermoplastic Belt Sheath

Blade Length
3.8" (9.6 cm)
Overall Length
11.8" (30.0 cm)
Weight
1 lb. 6.4 oz.



SCAXE2 SMALL AXE BLACK HANDLE BOX
UPC - 044356216821
SCAXE2CP SMALL AXE BLACK HANDLE CLAM
UPC - 044356217873

SCAXE10

HATCHET

Blade Length 3.6" (9.0 cm) Weight 1 lb. 5.9 oz.
Overall Length 11.1" (28.1 cm)

STAINLESS STEEL BLADE
TPR HANDLE

- » Full Targ
- » Hammer Pommel
- » Thermoplastic Belt Sheath



SCAXE10 HATCHET BLACK HANDLE BOX
UPC - 044356225502
SCAXE10CP HATCHET BLACK HANDLE CLAM
UPC - 044356227315

SCHCOM6CP

HATCHET/MINI MACHETE COMBO

STAINLESS STEEL BLADE

TPR HANDLE

- » Full Tang
- » Individual Belt Sheaths

HATCHET

Blade Length
3.6" (9.0 cm)
Overall Length
11.1" (28.1 cm)
Weight
1 lb. 5.9 oz.



MACHETE

Blade Length
8.5" (21.5 cm)
Overall Length
14.6" (37.0 cm)
Weight
12 oz.
UPC
044356229968
*Only Available
in Clam Pack*



SCAXE5

TACTICAL HATCHET

SK-5 HIGH CARBON STEEL BLADE
NYLON FIBER HANDLE

Blade Length 3.1" (7.9 cm) Weight 1 lb. 9 oz.
Overall Length 12.8" (32.5 cm) UPC 044356220422

- Nail Pull/Pry Bar
- Spike Pommel
- Nylon Belt Sheath w/Belt Loop



SCSH1

TELESCOPING SHOVEL

1055 CARBON STEEL SHOVEL
PP HANDLE

- T-Handle for Better Leverage
- 19" Telescoping Handle
- Sharpened Edges
- Polyester Sheath

Blade Length 7.4" (18.9 cm)
Overall Length 16.6" (42.1 cm)
Weight 1 lb. 15.7 oz.
UPC 044356223768



16.6"



Folds for Easy Storage

SCP18X**PRY BAR**

Overall Length 7.5" (19.1 cm)
 Weight 4.1 oz.
 UPC 044356222433

- » Powder Coated SK-5 High Carbon Steel
- » Bending Strength: 394 lbf (179 kgf)

**ST12****KEYCHAIN MULTI-TOOL****9 FUNCTIONS**

- » Keychain Lanyard
- » Pliers
- » Wire Stripper
- » Bottle Opener
- » Scissors
- » Screwdriver
- » Phillips Head Screwdriver
- » Tweezers
- » Drop Point Knife

Closed Length 2.6" (6.5 cm)
 Overall Length 4.2" (10.5 cm)
 Weight 2.1 oz.



ST12 MULTI-TOOL GREEN HANDLE BOX
 UPC - 044356229975
ST12CP MULTI-TOOL GREEN HANDLE CLAM
 UPC - 044356229982

ST12TSACP

KEYCHAIN MULTI-TOOL

NOTICE: Before traveling with this product, be sure to check the rules and regulations applicable to your mode of transportation for any restrictions regarding this product.

9 FUNCTIONS

- » Keychain Lanyard
- » Pliers
- » Wire Stripper
- » Bottle Opener
- » Scissors
- » Screwdriver
- » Phillips Head Screwdriver
- » Tweezers
- » File



Closed Length
2.6" (6.5 cm)

Overall Length
4.2" (10.5 cm)

Weight
2.1 oz.

UPC
044356229999

Only Available in Clam Pack



ST11

TOUGH MULTI-TOOL

9 FUNCTIONS

- » Needle Nose Pliers
- » Regular Pliers
- » Wire Cutter
- » Fine Edge Blade
- » Small Phillips Head Screwdriver
- » Small Flat Head Screwdriver
- » Fine Grit File
- » Bottle Opener
- » Heavy-Duty Scissors
- » Pocket Clip
- » Molded Polyester Belt Sheath



ST11CP CLAM
UPC 044356226479

Steel
Closed Length
Overall Length
Weight
LPC

2Cr13 Steel
4.1" (10.4 cm)
6.2" (15.8 cm)
6.3 oz.
044356227605



ST10
TOUGH MULTI-TOOL
14 FUNCTIONS

- » Needle Nose Pliers
- » Regular Pliers
- » Wire Cutter
- » Fine Edge Blade
- » Small Phillips Head Screwdriver
- » Can Opener
- » Ruler
- » Fine Grit File
- » Hexagon Wrench - 3 Sizes
- » Large Screwdriver
- » Small Screwdriver
- » Bottle Opener
- » Nail Puller
- » Saw
- » Spring-Loaded
- » Molded Polyester Belt Sheath

ST10CP CLAM

UPC 044356226226

Steel	2Cr13 Steel
Handle	Titanium Coated 2Cr13 Steel
Closed Length	4.2" (10.6 cm)
Overall Length	6.5" (16.5 cm)
Weight	8.6 oz.
UPC	044356227612

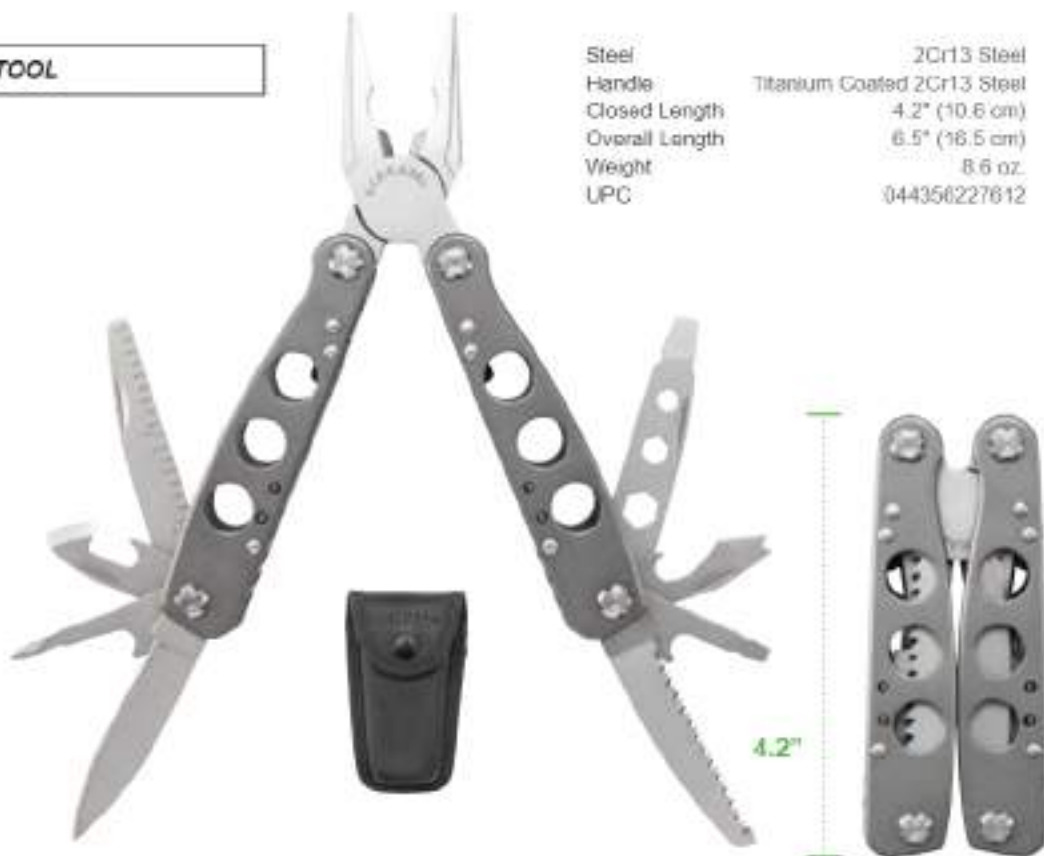
ST11
TOUGH MULTI-TOOL
21 FUNCTIONS

- » Needle Nose Pliers
- » Regular Pliers
- » Vise
- » Wire Cutter
- » Cap Lifter
- » Can Opener
- » Locking Phillips Screwdriver
- » Scribe
- » Awl
- » Leather Bore
- » Locking Dual Edge Knife Blade
- » Metal File
- » Wood File
- » Measuring Gauge
- » Hook Disgorger
- » Locking Heavy-Duty Saw Blade
- » Scraping Blade
- » Wire Strippers
- » Locking Large Flat Screwdriver
- » Fine Flat Head Screwdriver
- » Lanyard Attachment
- » Polyester Belt Sheath

Steel	2Cr13 Steel
Closed Length	4.8" (12.2 cm)
Overall Length	7" (17.8 cm)
Weight	8.1 oz.
UPC	044356013031

ST11CP CLAM

UPC 044356013046

ST1NB

TOUGH MULTI-TOOL

20 FUNCTIONS

- » Needle Nose Pliers
- » Regular Pliers
- » Vise
- » Wire Cutter
- » Cap Lifter
- » Can Opener
- » Locking Phillips Screwdriver
- » Scribe
- » Awl
- » Leather Bore
- » Locking Dual Edge Knife Blade
- » Metal File
- » Wood File
- » Heavy-Duty Scissors
- » Locking Heavy-Duty Saw Blade
- » Scraping Blade
- » Wire Strippers
- » Locking Large Flat Screwdriver
- » Fine Flat Head Screwdriver
- » Lanyard Attachment
- » Polyester Belt Sheath

Steel
 Closed Length
 Overall Length
 Weight
 UPC

2Cr13 Steel
 4.8" (12.2 cm)
 7" (17.8 cm)
 8.1 oz.
 044356203227



ST1NBCP CLAM

UPC 044356205702

SCPEN9BK

TACTICAL PUSH BUTTON PEN

CNC MACHINED 6061 T6 ALUMINUM

- » Pocket Clip
- » Easyflow Schmidt P900M Parker Style
 Black Ball Point Cartridge

Overall Length

5" (12.8 cm)

Weight

1.8 oz.

UPC

044356222693



BLACK

SCPENBK & SCPENG

TACTICAL PEN

CNC MACHINED 6061 T6 ALUMINUM

- * Pocket Clip
- * Schmidt P900 Parker Style Black Ball Point Cartridge

Overall Length
5.7" (14.5 cm)

Weight
1.4 oz.

PEN REFILL

UPC - 044356206679



5.7"



BLACK



GREY

SCPENBK

BLACK PEN

UPC - 044356208550

SCPENG

GREY PEN

UPC - 044356206655

TACTICAL SURVIVAL PEN

SCPEN4BK

TACTICAL SURVIVAL PEN

CNC MACHINED 6061 T6 ALUMINUM

- * Whistle Cap (110 dB)
- * Striker Plate
- * Ferro Rod
- * Pocket Clip
- * Black Siaminen Fine Point D1 Pen Cartridge

Overall Length
5.9" (15.0 cm)

Weight
1.7 oz.

UPC
044356216128



5.9"



BALL POINT PEN



DEFENSIVE END POINT



EMERGENCY WHISTLE CAP



FERRO ROD



STRIKER PLATE



IMPERIAL®

TRADITIONAL FOLDERS // FOLDING KNIVES & COMBOS

IMPERIAL

Imperial

IMPERIAL TRADITIONAL FOLDERS



IMPCOM1CP

IMP41 & IMP43
COMBO

UPC:
044356229388



IMPCOM3CP

IMP42 & IMP45
COMBO

UPC:
044356229401



IMPCOM4CP

IMP40, IMP44 &
IMP45 COMBO

UPC:
044356229418

- 3Cr13MoV S.S.
- Clip Point Blade



2.9"

IMP41

LOCKBACK

Blade Length 2.2" (5.6 cm)
Overall Length 5.1" (13.0 cm)
Weight 1.4 oz.
UPC 044356228756

- 3Cr13MoV S.S.
- Clip Point Blade
- Pen Blade



2.8"

IMP42

DOG LEG JACK

Blade Length 2.1" (5.3 cm)
Overall Length 5" (12.7 cm)
Weight 1.2 oz.
UPC 044356228763

- 3Cr13MoV S.S.
- Clip Point Blade
- Sheepfoot Blade
- Pen Blade



3.25"

IMP45

STOCKMAN

Blade Length 2.4" (6.2 cm)
Overall Length 5.7" (14.4 cm)
Weight 1.7 oz.
UPC 044356229081

- 3Cr13MoV S.S.
- Drop Point Blade
- Pen Blade
- Stainless Steel Bolsters



3"

IMP1011

SMALL CANOE

Blade Length 2.2" (5.6 cm) Weight 1.8 oz.
Overall Length 5.2" (13.2 cm) UPC 044356215458

- 3Cr13MoV S.S.
- Drop Point Blade
- Pen Blade
- Stainless Steel Bolsters



3.6"

IMP11

LARGE CANOE

Blade Length 2.5" (6.4 cm) Weight 2.5 oz.
Overall Length 6.1" (15.5 cm) UPC 044356215442

IMPERIAL

TRADITIONAL FOLDERS

- 3Cr13MoV S.S.
- Clip Point Blade
- Spey Blade
- Stainless Steel Bolsters



IMP13

TRAPPER

Blade Length 2.2" (5.6 cm) Weight 1.4 oz.
Overall Length 5" (12.7 cm) UPC 044356204767

- 3Cr13MoV S.S.
- Clip Point Blade
- Spey Blade
- Stainless Steel Bolsters



IMP13L

LARGE TRAPPER

Blade Length 3" (7.6 cm) Weight 3.0 oz.
Overall Length 7" (17.8 cm) UPC 044356204774

- 3Cr13MoV S.S.
- Clip Point Blade
- Sheepfoot Blade
- Spey Blade
- Stainless Steel Bolsters



IMP14

STOCKMAN

Blade Length 1.8" (4.6 cm) Weight 1.1 oz.
Overall Length 4.5" (11.4 cm) UPC 044356204781

- 3Cr13MoV S.S.
- Clip Point Blade
- Sheepfoot Blade
- Spey Blade
- Stainless Steel Bolsters



IMP14L

LARGE STOCKMAN

Blade Length 3" (7.6 cm) Weight 2.8 oz.
Overall Length 6.9" (17.5 cm) UPC 044356204798

- 3Cr13MoV S.S.
- Spear Point Blade
- Coping Blade
- Pen Blade
- Stainless Steel Bolsters



IMP9

CIGAR WHITTLES

Blade Length 3" (7.6 cm) Weight 2.3 oz.
Overall Length 6.9" (17.5 cm) UPC 044356215468

- 3Cr13MoV S.S.
- Sheepfoot Blade (2)
- Coping Blade
- Pen Blade
- Stainless Steel Bolsters



IMP20CI

CONGRESS

Blade Length 2.2" (5.6 cm) Weight 2.3 oz.
Overall Length 5.8" (14.7 cm) UPC 044356205696

IMPERIAL TRADITIONAL FOLDERS

- 3Cr13MoV S.S.
- Drop Point Blade
- Lockback
- Stainless Steel Bolsters



3.72"

IMP23

LOCKBACK

Blade Length	2.6" (6.5 cm)	Weight	2.8 oz
Overall Length	6.3" (15.9 cm)	UPC	044356222716

- 3Cr13MoV S.S.
- Clip Point Blade
- Small Clip Point Blade
- Pen Blade
- Stainless Steel Bolsters



3.52"

IMP24

WHITTLER

Blade Length	2.3" (5.9 cm)	Weight	2.5 oz
Overall Length	5.8" (14.8 cm)	UPC	044356222723

- 3Cr13MoV S.S.
- Clip Point Blade
- Sheepfoot Blade
- Spey Blade
- Stainless Steel Bolsters



3.76"

IMP25

SOWBELLY

Blade Length	2.7" (6.7 cm)	Weight	3.0 oz
Overall Length	6.4" (16.2 cm)	UPC	044356222730

- 3Cr13MoV S.S.
- Clip Point Blade
- Sheepfoot Blade
- Spey Blade
- Stainless Steel Bolsters



3.4"

IMP155

STOCKMAN

Blade Length	2.5" (6.4 cm)	Weight	1.9 oz
Overall Length	5.9" (15.0 cm)	UPC	044356205511

- 3Cr13MoV S.S.
- Clip Point Blade
- Spey Blade
- Stainless Steel Bolsters



3.5"

IMP151

TRAPPER

Blade Length	2.7" (6.8 cm)	Weight	2.5 oz
Overall Length	6.2" (15.7 cm)	UPC	044356205504

- 3Cr13MoV S.S.
- Sheepfoot Blade (2)
- Coping Blade
- Pen Blade
- Stainless Steel Bolsters



3.8"

IMP150K

CONGRESS

Blade Length	2.1" (5.3 cm)	Weight	2.5 oz
Overall Length	5.7" (14.5 cm)	UPC	044356206549

IMPERIAL

TRADITIONAL FOLDERS

- 3Cr13MoV S.S.
- Clip Point Blade
- Sheepfoot Blade
- Spey Blade
- Stainless Steel Bolsters



IMP16S

STOCKMAN

Blade Length 2.5" (6.4 cm) Weight 1.9 oz.
Overall Length 5.0" (15.0 cm) UPC 044356205535

- 3Cr13MoV S.S.
- Clip Point Blade
- Spey Blade
- Stainless Steel Bolsters



IMP16T

TRAPPER

Blade Length 2.7" (6.8 cm) Weight 2.5 oz.
Overall Length 6.2" (15.7 cm) UPC 044356205528

- 3Cr13MoV S.S.
- Sheepfoot Blade (2)
- Coping Blade
- Pen Blade
- Stainless Steel Bolsters



IMP16CON

CONGRESS

Blade Length 2.1" (5.3 cm) Weight 2.5 oz.
Overall Length 5.7" (14.5 cm) UPC 044356206556

- 3Cr13MoV S.S.
- Clip Point Blade
- Sheepfoot Blade
- Spey Blade
- Stainless Steel Bolsters



IMP17S

STOCKMAN

Blade Length 2.5" (6.4 cm) Weight 1.9 oz.
Overall Length 5.9" (15.0 cm) UPC 044356205559

- 3Cr13MoV S.S.
- Clip Point Blade
- Spey Blade
- Stainless Steel Bolsters



IMP17T

TRAPPER

Blade Length 2.7" (6.8 cm) Weight 2.5 oz.
Overall Length 6.2" (15.7 cm) UPC 044356205542

- 3Cr13MoV S.S.
- Sheepfoot Blade (2)
- Coping Blade
- Pen Blade
- Stainless Steel Bolsters



IMP17CON

CONGRESS

Blade Length 2.1" (5.3 cm) Weight 2.5 oz.
Overall Length 5.7" (14.5 cm) UPC 044356206532

IMPERIAL TRADITIONAL FOLDERS

- 3Cr13MoV S.S.
- Clip Point Blade
- Sheepfoot Blade
- Spy Blade
- Stainless Steel Bolsters



2.7"

IMP19PRS

STOCKMAN

Blade Length 1.9" (4.8 cm) Weight 1.1 oz.
Overall Length 4.5" (11.4 cm) UPC 044356205597

- 3Cr13MoV S.S.
- Clip Point Blade
- Spy Blade
- Stainless Steel Bolsters



2.8"

IMP19PT

TRAPPER

Blade Length 2.2" (5.6 cm) Weight 1.4 oz.
Overall Length 5" (12.7 cm) UPC 044356205590

- 3Cr13MoV S.S.
- Clip Point Blade
- Sheepfoot Blade
- Spy Blade
- Stainless Steel Bolsters



2.7"

IMP18PS

STOCKMAN

Blade Length 1.8" (4.6 cm) Weight 1.1 oz.
Overall Length 4.5" (11.4 cm) UPC 044356205573

- 3Cr13MoV S.S.
- Clip Point Blade
- Spy Blade
- Stainless Steel Bolsters



2.8"

IMP18PT

TRAPPER

Blade Length 2.2" (5.6 cm) Weight 1.4 oz.
Overall Length 5" (12.7 cm) UPC 044356205566

- 3Cr13MoV S.S.
- Clip Point Blade
- Stainless Steel Bolsters



2.8"

IMP21CI

PEANUT

Blade Length 1.9" (4.8 cm) Weight 0.9 oz.
Overall Length 4.7" (11.9 cm) UPC 044356206730

- 7Cr17MoV S.S.
- Drop Point Blade
- Stainless Steel Bolsters



3.7"

IMP22

FOLDER

Blade Length 2.7" (6.8 cm) Weight 2.1 oz.
Overall Length 6.4" (16.2 cm) UPC 044356207171

IMPERIAL FOLDING KNIVES & COMBOS

- 7Cr17MoV S.S.
- Drop Point Blade
- Stainless Steel Bolsters



IMP221	LARGE FOLDER		
Blade Length	3.6" (9.2 cm)	Weight	3.5 oz
Overall Length	8.3" (21.1 cm)	UPC	044356207188

- 7Cr17MoV S.S.
- Drop Point Blade
- Stainless Steel Bolsters



IMP221	FOLDER		
Blade Length	2.7" (6.8 cm)	Weight	2.1 oz
Overall Length	6.4" (16.2 cm)	UPC	044356207195

- 3Cr13MoV S.S.
- Clip Point Blade
- Pen Blade
- Stainless Steel Bolsters



27B	JACKMASTER BARLOW		
Blade Length	2.4" (6.1 cm)	Weight	2.3 oz
Overall Length	5.7" (14.5 cm)	UPC	072146108032

- Stainless Steel
- Nail Groove



SS102	SAMPLER FRUIT		
Blade Length	3.7" (9.4 cm)	Weight	1.8 oz
Overall Length	8.3" (21.1 cm)	UPC	044356005234

IMP35COM5CP

IMP35 COMBO PACK

3Cr13MoV S.S. BLADE

PLASTIC W/IRUBBER INSERT HANDLE

- Ambidextrous Thumb Hole
- Lockback
- Pocket Clip

Blade Length
2.4" (6.0 cm)

Overall Length
5.5" (14.0 cm)

Weight
1.2 oz.

UPC
044356229432

Only Available in Clam Pack



3.22"



IMP35COM3CP

IMPERIAL® FOLDING KNIFE COMBO

3Cr13MoV S.S. BLADE

PLASTIC HANDLE

- Lockback
- Lanyard Hole

SP1

Blade Length
2.1" (5.3 cm)

Overall Length
4.3" (10.9 cm)

Weight
1.7 oz.

SP2

Blade Length
2.5" (6.4 cm)

Overall Length
5.4" (13.7 cm)

Weight
2.3 oz.

SP3

Blade Length
3" (7.6 cm)

Overall Length
6.6" (16.8 cm)

Weight
2.8 oz.

UPC
044356229449

Only Available in Clam Pack



+ SP1

+ SP2

+ SP3



4.3"



5.4"



6.6"

IMP4SBCP

SNOWBLIND FOLDING KNIFE

3Cr13MoV S.S. BLADE

ALUMINUM & RUBBER HANDLE

- Ambidextrous Thumb Hole
- Liner Lock
- Pocket Clip

Blade Length

3" (7.6 cm)

Overall Length

7" (17.8 cm)

Weight

3.8 oz.

UPC

044356229425

Only Available
in Clam Pack



3.9"



IMP4COMTCP

SNOWBLIND FOLDING KNIFE COMBO

3Cr13MoV S.S. BLADE

ALUMINUM & RUBBER HANDLE

- Ambidextrous Thumb Hole
- Liner Lock
- Pocket Clip

Blade Length

3" (7.6 cm)

Overall Length

7" (17.8 cm)

Weight

3.8 oz.

UPC

044356229777

Only Available
in Clam Pack



3.9"



IMP104BCP

FOLDING KNIFE

3Cr13MoV S.S. BLADE

RUBBERIZED ALUMINUM HANDLE

- Dual Thumb Knobs
- Liner Lock
- Pocket Clip

Blade Length
3.4" (8.5 cm)

Overall Length
7.9" (20.0 cm)

Weight
4.3 oz.

UPC
044356229021

*Only Available
in Clam Pack*



IMPERIAL FOLDING KNIVES & COMBOS

IMPCOM9CP

SW3 & MULTI-TOOL COMBO

MULTI-TOOL

17 FEATURES

- Needle Nose Pliers
- Regular Pliers
- Wire Cutter
- Wire Strippers
- Fine Edge Blade
- Small Phillips Head
- Can Opener/Bottle Opener/Scraping Blade
- Fine Flat Head Screwdriver
- Saw/Nail Puller
- Fine Grit File/Large Flat Head Screwdriver
- Awl
- Small Flat Head Screwdriver
- Locking Tools
- Polyester Belt Sheath

Closed Length
4.25" (10.7 cm)

Overall Length
6.3" (16.0 cm)

Weight
10.5 oz

UPC

044356229487

Only Available
in Clam Pack



SP3 LOCKBACK

- 3Cr13MoV Stainless Steel
- Plastic Handle

Blade Length
3" (7.6 cm)

Overall Length
6.0" (15.8 cm)

Weight
2.8 oz.

IMPCOM10CP

TRADESMAN® TM1 & TM2 COMBO

3Cr13MoV S.S. BLADE

PLASTIC HANDLE

- Lockblade
- Screwdriver Tip
- Shackle

TM1 HAWKBILL

Blade Length
3" (7.6 cm)
Overall Length
7.1" (18.0 cm)
Weight
2.2 oz.

TM2 ELECTRICIAN

Blade Length
2.7" (6.9 cm)
Overall Length
8.4" (21.3 cm)
Weight
2.2 oz.
UPC
044356229456

Only Available in Clam Pack



IMPCOM10CP CLAM
UPC 044356229456



+ TM1

4.25"



+ TM2

3.75"

TRADESMAN

QUALITY CUTTING TOOLS



ust™

2021
new products

the new ust

Since 1936 ust has been creating survival, camping and outdoor equipment. Recently, we moved headquarters from Jacksonville, FL up to Columbia, Mo... and we've taken this opportunity to re-imagine what ust can be moving forward. The ust crew is driven by our calling to explore outdoors. We feel incredibly lucky to have the rolling hills and hollers of the Ozark Mountains for our backyard... product testing, exploring, work, play... the lines get blurry.

Our ever-present drive to "be outdoors" translates into reliable, problem-solving gear for you to use in your own outdoor adventures. As a brand, our goal is to inspire and cultivate people's love of all things outside. We set out on this path with strong intention going forward... to create gear that allows EVERYONE to enjoy the activities that give us so much happiness.





#1121062
 upc: 661120104520
 packaged dims: 12 x 6 x 4.5 in
 case pack qty: 4

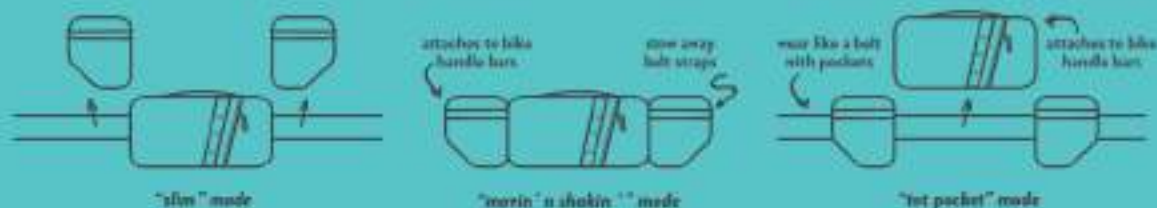

swerve™

Here's no denying it... the fanny pack is back. This stylish pack has specific features and functions to make it an incredibly versatile carry solution. From chapstick specific storage to bicycle handlebar tab mounts, this pack has it all.

- durable multi-fabric/textured style
- pockets for phones, keys, chapstick, energy bars
- padded/fleece-lined sunglasses/phone pocket
- modular system with multiple wear options
- bicycle handlebar attachment system
- funky, unique stitch details
- wears well as traditional hip pack or sling
- total bag dimensions: 20.75 in x 5.55 in x 3.5 in
- main compartment: 11 in x 5.5 in x 3.5 in
- side compartments (each): 5 in x 5.5 in x 2 in
- waistbelt: 60 in x 2 in
- total weight: 14 oz
- total bag volume: 5.5 L
- main compartment volume: 3.5 L
- side compartment volume (each): 1 L
- 600 denier polyester with PU backing
- supportive breathable airmesh
- durable SBS injection molded zippers
- 50 mm durable YKK plastic buckles



regular E1121066
upc: 661120104698
packaged dims: 18 x 9 x 9 in
case pack qty: 2

monarch[™] (regular)

The most revolutionary sleeping bag design on the market is finally here. The “wings” on our new monarch[™] sleeping bag allow for an unprecedented temperature comfort range. Simply fold the wings forward over yourself for a 17°F bag, or fold them behind (or remove them quickly) for a 37°F bag.

- wings can fold forward for 17°F bag
- wings are detachable or can fold back for 37°F bag
- one wing on top and one behind creates a 24°F bag
- vent-able footbox
- if removed, each wing stuffs into itself to form a camp pillow
- compression stuff sack included
- 100% cotton storage bag included
- regular: 80.3 in x 32.3 in
- weight: 4 lb 2 oz | w/o wings: 2 lb 3 oz
- packed size: 13 in x 8.5 in
- 100% poly fill made from recycled bottles
- body: 150 g
- footbox/hood: 150 g
- two wings: 220 g
- hip girth: 64 in
- shoulder girth: 61 in
- 20D waterproof ripstop nylon fabric



short 81121057
 ipc: 661120104704
 packaged dims: 17 x 8.5 x 8.5 in
 case pack qty: 2

monarch[™] (short)

The most revolutionary sleeping bag design on the market is finally here. The “wings” on our new monarch[™] sleeping bag allow for an unprecedented temperature comfort range. Simply fold the wings forward over yourself for a 17°F bag, or fold them behind (or remove them quickly) for a 37°F bag.

- wings can fold forward for 17°F bag
- wings are detachable or can fold back for 37°F bag
- one wing on top and one behind creates a 24°F bag
- vent-able footbox
- if removed, each wing stuffs into itself to form a camp pillow
- compression stuff sack included
- 100% cotton storage bag included
- short: 74 in x 30 in
- weight: 3 lb 8 oz | w/o wings: 2 lb
- packed size: 13 in x 8.5 in
- 100% poly fill made from recycled bottles
- body: 150 g
- footbox/hood: 150 g
- two wings: 220 g
- hip girth: 59 in
- shoulder girth: 61 in
- 20D waterproof ripstop nylon fabric



conifer regular #1138772
upc: 661120104599
packaged dims: 18.7 x 4.5 x 8.8 in
case pack qty: 4



min view regular #1121064
upc: 661120104575
packaged dims: 18.7 x 4.5 x 8.8 in
case pack qty: 4

freestyle[™] (regular)

The freestyle[™] is everything you could want from a lightweight, compact, airmat. This backpacking mat offers the ideal solution for when space and weight are important. With its small packing size and 3.5 in of comforting thickness, the freestyle[™] gives you freedom to roam and explore as you please.

- lightweight
- loud, funky designs are unique compared to others in the market
- easy inflation with included stuff sack pump
- packable
- unique "body map baffles" put extra comfort where you need it and cut weight where you don't

- regular: 72 in x 20 in x 3.5 in
- regular: 17 oz
- R value: 1.7
- TPU coated polyester fabric
- easy-to-use, one-way valve



conifer short #1121065
upc: 661120104681
packaged dims: 15.5 x 4.1 x 10 in
case pack qty: 4



mtn view short #1138726
upc: 661120104605
packaged dims: 15.5 x 4.1 x 10 in
case pack qty: 4

freestyle[™] (short)

The freestyle[™] is everything you could want from a lightweight, compact, airmat. This backpacking mat offers the ideal solution for when space and weight are important. With its small packing size and 3.5 in of comforting thickness, the freestyle[™] gives you freedom to roam and explore as you please.

- lightweight
- loud, funky designs are unique compared to others in the market
- easy inflation with included stuff sack pump
- packable
- unique "body map baffles" put extra comfort where you need it and cut weight where you don't

- short: 46 in x 20 in x 3.5 in
- short: 12 oz
- R value: 1.7
- TPU coated polyester fabric
- easy-to-use, one-way valve



conifer regular #1134971
upc: 661120104568
packaged dims: 26.8 x 13.2 x 6.5 in
case pack qty: 3



mtn view regular #1134953
upc: 661120104551
packaged dims: 26.8 x 13.2 x 6.5 in
case pack qty: 3

filmatic^(regular)[™]

The people have spoken, and they want to be comfortable. The filmatic[™] camp comfort airmat has all the cushion and size to make you feel like you're sleeping at home.

- loud, funky designs unlike any on the market
- ability to clip two mats together to create a double bed
- ultra comfort foam core with horizontal baffles
- unique 2 way flip valve allows for easy inflation and deflation
- self-inflating (takes seconds to inflate on its own)
- regular: 72 in x 25 in x 4 in
- packed size: 26 in x 7 in
- weight: 4 lbs 11 oz
- R value: 6
- top & side: 30D stretch fabric w/ TPU coating
- bottom: 190T polyester w/ TPU coating



conifer xl #1134948
upc: 661120104544
packaged dims: 31.7 x 12.2 x 6.5 in
case pack qty: 2



mtn view xl #1121063
upc: 661120104537
packaged dims: 31.7 x 12.2 x 6.5 in
case pack qty: 2

filmatic^(xl)

The people have spoken, and they want to be comfortable. The filmatic™ camp comfort airmat has all the cushion and size to make you feel like you're sleeping at home.

- loud, funky designs unlike any on the market
- ability to clip two mats together to create a double bed
- ultra comfort foam core with horizontal baffles
- unique 2 way flip valve allows for easy inflation and deflation
- self-inflating (takes seconds to inflate on its own)
- xl: 80 in x 30 in x 4 in
- packed size: 31 in x 8 in
- weight: 5 lbs 5 oz
- R value: 6
- top & side: 30D stretch fabric w/ TPU coating
- bottom: 190T polyester w/ TPU coating



#1121089
upc: 66020104728
packaged dims: 22 x 7 x 7 in
case pack qty: 1

house party™ 4

The house party™ 4 comes from years of tent design expertise. This tent is unique in many ways, from the expandable walls to the massive front and rear doors. The simple and elegant single layer design makes this a breeze to set up and take down. The house party™ 4 will no doubt be the talk of the campground.

- expandable interior space
- single wall construction for simple quick setup
- large vents on both sides (plus door venting)
- extra large front and rear door for ease of loading cot/airmats
- poles and sleeves are color coded for easy setup
- oversized footprint and maximized interior space for extra comfort
- extra durable 150D oxford floor
- integrated storage pocket system
- assembled size: 8 ft 2 in x 7 ft 1 in x 5 ft 8 in
- packed size: 22.5 in x 7.5 in x 7.5 in
- weight: 9 lb 8 oz
- flysheet: 66D 190T polyester PU2500 mm seams taped
- mesh: poly no-see-um mesh
- floor: durable poly 150D oxford
- poles: 7075 series aluminum (11 mm (2 pcs), 9.5 mm (2 pcs))
- package: 66D 190T polyester PU2500 mm
- parts: j-shaped hexagon extruded 7 in aluminum stakes (12 pcs)
- sleeves: durable poly 150D oxford w/ 300d reinforced areas



#1121070
upc: 66120104735
packaged dims: 23.3 x 7.9 x 7.9 in
case pack qty: 1

house party™ 6

The house party™ 6 comes from years of tent design expertise. This tent is unique in many ways, from the expandable walls to the massive front and rear doors. The simple and elegant single layer design make this a breeze to set up and take down. The house party™ 6 will no doubt be the talk of the campground.

- expandable interior space
- single wall construction for simple quick setup
- large vents on both sides (plus door venting)
- extra large front and rear door for ease of loading cots/airmats
- poles and sleeves are color coded for easy setup
- oversized footprint and maximum interior space for extra comfort
- extra durable 150D oxford floor
- integrated storage pocket system
- assembled size: 10 ft 7 in x 8 ft x 6 ft 3 in
- packed size: 23.5 in x 8.5 in x 8.5 in
- weight: 13 lb 2 oz
- flysheet: 66D 190T polyester PU2500 mm seams taped
- mesh: poly no-see-um mesh
- floor: durable poly 150D oxford
- poles: 7075 series aluminum (11 mm (3 pcs), 9.5 mm (2 pcs))
- package: 66D 190T polyester PU2500 mm
- parts: j-shaped hexagon extruded 7 in aluminum stakes (12 pcs)
- sleeves: durable poly 150D oxford w/ 300d reinforced areas



#1121068
upc: 6611020104711
packaged dims: 17.5 x 5.1 x 5.1 in
case pack qty: 1

highlander™

The highlander™ is as roomy as it gets for a lightweight backpacking tent. This trail mansion also happens to be a unique blend of the highest quality materials and construction available at a reasonable price. The highlander™ features one oversized main vestibule at the door with a "secret-stash" back vestibule for additional storage (accessible from inside the tent). The gigantic footprint, featuring extra space between the fly and inner tent, allows for maximum air circulation and comfort.

- 3 seasons
- lightweight (3 lb 4 oz minimum trail weight)
- 4 lb 2 oz fully packed with footprint
- 2 awnings (1 large, 1 small with access from inside tent)
- poles and sleeves are color coded for easy setup
- massive interior with comfortable livable space
- footprint included
- integrated storage pocket system and gear loft
- assembled size: 7 ft 1 in x 4 ft 1 in x 2 ft 20 in
- packed size: 18 in x 7 in x 6 in
- flysheet: 15D nylon PU2500 mm seams taped
- body: poly see-see-um mesh
- floor: 40D nylon PU2500 mm seams taped
- groundsheet: 150D poly oxford
- poles: 7075 series aluminum (8 mm (4 pcs))
- parts: y-shaped 5.5 in ultralight aluminum stakes (12 pcs), guy ropes (6 pcs)
- mesh accessory pocket included
- gear loft included



ust

returning
products

lighting



SLIM™ 1100 LED EMERGENCY LIGHT

The Slim 1100 LED Emergency Light is compact, lightweight and USB rechargeable for up to 10 hours in warm white light mode. Perfect for the commute or at-home emergencies, the integrated handle allows the light to be hung anywhere or propped up for area illumination.

- Shines at up to 1100 lumens in Natural Light Mode
- Runs for up to 10 hours in Warm White Mode
- Lightweight and compact with the power of a full-size lantern
- Amber Nightlight Mode is perfect for use in a tent
- Great for emergency backup lighting
- Battery indicator light shows battery life when light is in use
- Tripod compatible
- MODES: AMBER NIGHTLIGHT>WARM WHITE>COOL WHITE>NATURAL LIGHT>OFF
- BATTERY: Rechargeable lithium-ion battery (included)
- SIZE HxWxD: 6.7" x 4.1" x 1.2" (168 x 104 x 30mm)
- WEIGHT: 10.6 oz (301g) with battery

PART NUMBER	COLOR	UPC
20-12454	Gray	815608074545

	AMBER NIGHTLIGHT	WARM WHITE	COOL WHITE	NATURAL LIGHT
☀️	1 HOUR	210 HOURS	915 HOURS	1100 HOURS
🌙	230 HOURS	10 HOURS	5 HOURS	2.5 HOURS
✓	2 METERS			
🌧️	IPX4			



SLIM™ 400 LED EMERGENCY LIGHT

The Slim 400 LED Emergency Light is compact, lightweight and USB rechargeable for up to 12 hours of warm white light. Perfect for the commute or at-home emergencies, the integrated handle allows the light to be hung anywhere or propped up for area illumination.

- Shines at up to 400 lumens in Natural Light Mode
- Runs for up to 12 hours in Warm White Mode
- Lightweight and compact with the power of a full-size lantern
- Amber Nightlight Mode is perfect for use in a tent
- Great for emergency backup lighting
- Battery indicator light shows battery life when light is in use
- Tripod compatible
- MODES: AMBER NIGHTLIGHT>WARM WHITE>COOL WHITE>NATURAL LIGHT>OFF
- BATTERY: Rechargeable lithium-ion battery (included)
- SIZE HxWxD: 4" x 4" x 1.8" (102 x 102 x 46mm)
- WEIGHT: 6.8 oz (193g) with battery

PART NUMBER	COLOR	UPC
20-12455	Gray	815608074552

	AMBER NIGHTLIGHT	WARM WHITE	COOL WHITE	NATURAL LIGHT
☀️	1 HOUR	113 HOURS	363 HOURS	400 HOURS
🌙	200 HOURS	12 HOURS	7 HOURS	5 HOURS
✓	2 METERS			
🌧️	IPX4			

SPRIGHT® LED LANTERN

The Spright LED Lantern features a collapsible, silicone globe which diffuses the bright LED light for a pleasing soft light that will brighten the inside of your tent or campsite.

- Three long-lasting LED bulbs provide a bright 100 lumens on High
- Runs for up to 5 days continuously on Nightlight mode
- Sturdy base includes an integrated hook for hanging
- Silicone globe glows in the dark—expose to light source for 2+ hours of glow, collapses into base for storage
- IPX4 (protected against splashing water from all directions)
- MODES: HIGH>LOW>AMBER NIGHTLIGHT>OFF
- BATTERIES: 3 x AA batteries (not included)
- SIZE (expanded) HxW: 4.75" x 3.5" (121 x 89mm)
- SIZE (collapsed) HxW: 2.75" x 3.5" (70 x 89mm)
- WEIGHT: 7 oz (200g) with batteries



PART NUMBER	COLOR	UPC
1146778	Green	661120196746



	HIGH	LOW	AMBER NIGHTLIGHT	AMBER CANDLE FLICKER
☾	100 LUMENS	30 LUMENS	10 LUMENS	
☾	30 HOURS	40 HOURS	120 HOURS	
✓	1 METER			
☔	IPX4			

SPRIGHT® 3AAA LED LANTERN 2-PK

The Spright 3AAA LED Lantern offers the same collapsible silicone globe as the best Spright LED Lantern, but in a compact smaller size. The Spright 3AAA LED Lantern also offers a candle flicker mode to create a pleasing ambience, indoors or out.

- Long-lasting LED bulbs provide a bright 57 lumens on High
- Runs for up to 4 days continuously on the Nightlight setting
- Sturdy base includes an integrated hook for hanging
- IPX4 (protected against splashing water from all directions)
- MODES: HIGH>LOW>AMBER NIGHTLIGHT>AMBER CANDLE FLICKER>OFF
- BATTERIES: 3 x AAA batteries per unit (not included)
- SIZE (expanded) HxW: 3.75" x 2.6" (95 x 66mm)
- SIZE (collapsed) HxW: 2.25" x 2.6" (57 x 66mm)
- WEIGHT: 3.8 oz (108g) with batteries



PART NUMBER	COLOR	UPC
20-02980	Orange	811747329809



	HIGH	LOW	AMBER NIGHTLIGHT	AMBER CANDLE FLICKER
☾	57 LUMENS	18 LUMENS	N/A	N/A
☾	15 HOURS	47 HOURS	100 HOURS	100 HOURS
✓	1 METER			
☔	IPX4			

SPRIGHT® RECHARGE LED LANTERN WITH POWER BANK

The best Spright Recharge LED Lantern with Power Bank is an innovative USB rechargeable LED lantern. The included USB cord makes charging the lantern easy, allowing you to travel battery and fuel free. This lantern also doubles as a power bank, so you can charge your phone and other mobile devices on the go.

- Sturdy base includes an integrated hook for hanging
- Candle Flicker Mode is perfect for use in a tent
- Input: DC 5V/1.0A
- Output: DC 5V/1.0A
- Capacity: 3500mAh
- Charge time: 6 hours
- MODES: HIGH>LOW>AMBER NIGHTLIGHT>AMBER CANDLE FLICKER>OFF
- BATTERIES: Rechargeable lithium-ion battery (included)
- SIZE (expanded) HxW: 5" x 3.4" (127 x 86mm)
- SIZE (collapsed) HxW: 3.1" x 3.5" (80 x 89mm)
- WEIGHT: 4.8 oz (136g) with battery



PART NUMBER	COLOR	UPC
20-12144	Orange	815618021445



	HIGH	LOW	AMBER NIGHTLIGHT	AMBER CANDLE FLICKER
☾	100 LUMENS	40 LUMENS	N/A	N/A
☾	12 HOURS	25 HOURS	40 HOURS	40 HOURS
✓	1 METER			
☔	IPX4			

SPRIGHT® SOLAR USB LED LANTERN

The Spright Solar USB LED Lantern features a soft, silicone globe that collapses into the base for easy storage. The integrated solar panel fully recharges the lantern in direct sunlight so you never need batteries. Includes a USB cable as an alternative charging option.

- Integrated split bail hook for hanging
- IPX4 (protected against splashing water from all directions)
- Input: DC 5V/1.0A
- Capacity: 360mAh
- Full charge time via USB: 3 hours
- Full charge time via Solar Panel: 15-20 hours
- MODES: HIGH>LOW>AMBER NIGHTLIGHT>AMBER CANDLE FLICKER>OFF
- BATTERIES: Rechargeable lithium-ion battery (included)
- SIZE (expanded) HxW: 4.75" x 4.1" (121 x 105mm)
- SIZE (collapsed) HxW: 2" x 4.1" (51 x 105mm)
- WEIGHT: 6.3 oz (179g) with battery



PART NUMBER	COLOR	UPC
20-12145	Orange	815618021452



	HIGH	LOW	AMBER NIGHTLIGHT	AMBER CANDLE FLICKER
☾	120 LUMENS	30 LUMENS	N/A	N/A
☾	4 HOURS	7 HOURS	45 HOURS	45 HOURS
✓	1 METER			
☔	IPX4			



BRILA™ 580 DUAL POWER LED HEADLAMP

The Brila 580 Dual Power LED Headlamp features innovative hybrid battery technology to ensure you'll never without a light on your adventures. The included rechargeable battery provides up to 18 hours of white light on a single charge, also comes with a USB cord for easy recharging from any USB port. If you don't have a USB port when you need more power, the Brila 580 is also compatible with standard alkaline batteries. No adapter or special charger needed. Easy-to-use focus control adjustment provides a long-distance spot beam or broad flood beam of up to 580 lumens on High.

- Provides up to 580 lumens of bright, clean light on High
- Runs for up to 18 hours on Low
- Adjustable head strap for comfortable wear
- Head rotates to direct light as needed
- Features white and red modes
- Water resistant IPX4 (protected against splashing water from all directions)
- MODES: HIGH-MEDIUM-LOW-RED STEADY-ON-RED SOS FLASHING-OFF
- BATTERIES: Rechargeable lithium-ion battery (included) or 3 x AAA alkaline batteries (not included)
- SIZE (HxWxD): 2.5" x 1.4" x 1.7" (64 x 41 x 43mm)
- WEIGHT: 3.4 oz (95g) with battery

MODE	580 LUMENS	270 LUMENS	90 LUMENS	10 LUMENS	N/A
🔦	18h	9.5h	18h	13h	23h
🕒	2 METERS				
🛡️	IPX4				

*PERFORMANCE TESTED USING RECHARGEABLE BATTERY PACK



PART NUMBER	COLOR	UPC
20-12452	Black	815608024521



BRILA™ 550 LED HEADLAMP

The Brila 550 LED Headlamp will stay secure for all your outdoor adventures with its included top stability strap and even weight distribution between the front LED and rear battery pack. The easy-to-use focus control adjustment provides a long-distance spot beam or broad flood beam.

- Provides up to 550 lumens of bright, clean light on High
- Runs for up to 55 hours on Low
- Adjustable head strap for comfortable wear
- Features front white light modes and rear red light modes
- Water resistant IPX4 (protected against splashing water from all directions)
- MODES: Front: HIGH-MEDIUM-LOW-SOS FLASHING-OFF Rear: RED STEADY-ON-RED FLASHING-OFF
- BATTERIES: 3 x AA alkaline batteries (included)
- SIZE (HxWxD): 2.5" x 2.1" x 1.3" (74 x 53 x 33mm)
- WEIGHT: 7 oz (198g) with batteries

MODE	550 LUMENS	330 LUMENS	90 LUMENS	N/A	N/A	N/A
🔦	1h	11h	55h	50h	130h	150h
🕒	2 METERS					
🛡️	IPX4					

PART NUMBER	COLOR	UPC
20-12451	Black	815608024514



BRILA™ 450 LED HEADLAMP

Light up the night with the Brila 450 LED Headlamp. Separate batteries allow you to toggle between white lighting modes and red lighting modes independently of each other.

- Provides up to 450 lumens of bright, clean light on High
- Energy efficient COB LED runs for up to 40 hours on Low
- Adjustable head strap for comfortable wear
- Head rotates to direct light as needed
- Features white and red lighting modes; red modes are ideal for nighttime use
- Water resistant IPX4 (protected against splashing water from all directions)
- MODES: (White) HIGH-MEDIUM-LOW-SOS FLASHING-OFF (Red) STEADY-ON-SOS FLASHING-OFF
- BATTERIES: 3 x AAA alkaline batteries (included)
- SIZE (HxWxD): 2.5" x 1.4" x 1.6" (64 x 44 x 41mm)
- WEIGHT: 3.7 oz (105g) with batteries

MODE	450 LUMENS	150 LUMENS	20 LUMENS	N/A	20 LUMENS	N/A
🔦	3h	15h	40h	25h	18h	25h
🕒	2 METERS					
🛡️	IPX4					

PART NUMBER	COLOR	UPC
20-12453	Black	815608024538





60-DAY DURO™ LED LANTERN

- Bright, clean light—up to 1200 lumens
- Runs 60 days continuously on Low, 41 hours continuously on High
- Impact and weather-resistant rubberized ABS plastic case
- Built-in recessed hook on lantern base and removable globe for use as an area light
- IPX4 (protected against splashing water from all directions)
- MODES: HIGH>MEDIUM>LOW>SOS FLASHING>OFF
- BATTERIES: 6 x D Alkaline batteries (not included)
- SIZE HxWxD: 9.5" x 4.8" x 5.1" (241 x 122 x 131mm)
- WEIGHT: 1.1 lbs (1.4kg) with batteries

	HIGH	MEDIUM	LOW	SOS
	1200 LUMENS	300 LUMENS	20 LUMENS	N/A
	41 HOURS	192 HOURS	60 DAYS	15 DAYS
	1 METER			
	IPX4			

PART NUMBER	COLOR	UPC
1146729	Titanium	661120106524



30-DAY DURO™ 1000 LED LANTERN

Still runs for 30 days on low. Glow-in-the-dark power button for convenience. Modes are perfect for all campsite and home emergency needs with amber candle flicker mode for nighttime tent use. Still the best lantern for home emergencies and power outages.

- MODES: NATURAL LIGHT (HIGH)>COOL WHITE (MEDIUM)>WARM WHITE (LOW)>AMBER CANDLE FLICKER>SOS>OFF
- BATTERIES: 3 x D Alkaline batteries (not included)
- SIZE HxWxD: 7.2" x 3.75" (183 x 95mm)
- WEIGHT: 1.9 lbs (844g) with batteries

	HIGH	MEDIUM	LOW	SOS
	1000 LUMENS	400 LUMENS	20 LUMENS	N/A
	12 HOURS	30 HOURS	30 DAYS	N/A
	1 METER			
	IPX4			

PART NUMBER	COLOR	UPC
1156792	Orange	661120262275
1156908	Gray	661120262657

SEE-ME™ 1.0 LED LIGHT

On the trail or on the water, it's the perfect companion for your pack or PFD, ensuring you can be located quickly in an emergency.

- Runs for up to 17 continuous hours
- Visible up to 3.4 miles (5.5km) on a dark, clear night—exceeding USCG requirement of 1 nautical mile (1.9km)
- Easy twist ON/OFF
- Lanyard cord and hook-and-loop strap included

PART NUMBER	COLOR	UPC
20-51150-08	Orange	811747025375

- IPX7 (protected against water immersion for 30 minutes at 1 meter)
- BATTERIES: 2 x AAA (not included)
- SIZE LxW: 4.95" x 1.0" (126 x 25mm)
- WEIGHT: 1.8 oz (51g) with batteries



SEE-ME™ 1.0 LED STROBE

While on the trail or the water, attach to your pack or PFD to ensure you can be located quickly in an emergency.

- Runs for up to 44 continuous hours
- Strobe rate = 60 flashes per minute (1Hz)
- Visible up to 2.7 miles (4.3km) on a dark, clear night—exceeding USCG requirement of 1 nautical mile (1.9km)
- Easy twist ON/OFF
- Lanyard cord and hook-and-loop strap included

PART NUMBER	COLOR	UPC
1146794	Blue	66120106555

- IPX7 (protected against water immersion for 30 minutes at 1 meter)
- BATTERIES: 2 x AAA (not included)
- SIZE LxW: 4.95" x 1.0" (126 x 25mm)
- WEIGHT: 1.8 oz (51g) with batteries



SEE-ME™ 2.0 LED STROBE WATER ACTIVATION

This personal locator light is automatically triggered when it comes in contact with water and strobes 60 times per minute.

- Runs for up to 120 continuous hours
- Strobe rate = 60 flashes per minute (1Hz)
- Visible up to 3.1 miles (5.0km) on a dark, clear night—exceeding USCG requirement of 1 nautical mile (1.9km)
- Activates when submerged in water; will not automatically activate with rain, sea spray, or high humidity
- Includes PFD clip, lanyard cord, and hook-and-loop strap

PART NUMBER	COLOR	UPC
20-4025A-08	Orange	811747025399

- Easy twist ON/OFF
- IPX7 (protected against water immersion for 30 minutes at 1 meter)
- BATTERIES: 2 x AA (not included)
- SIZE LxW: 5.5" x 1.5" (140 x 40mm)
- WEIGHT: 4 oz (113g) with batteries



SEE-ME™ FLOATING LIGHT

The See-Me Floating Light is a dual-purpose buoyant personal safety light that is great for boating, fishing, and other water activities and features a red LED on the rear for added safety.

- Front white LED light shines up to 100 lumens for up to 4 hrs
- Thermo-plastic rubber construction for impact resistance
- Wrist lanyard included with integrated whistle for signaling
- IPX8 (protected against submersion in water for 4 hours at depths greater than 1 meter)
- MODES (FRONT): HIGH-LOW-OFF; MODES (REAR): WHITE STEADY-ON-RED STEADY-ON-RED FLASHING

PART NUMBER	COLOR	UPC
20-12209	Orange	815608023091

- Powered by 3 x AAA Alkaline batteries (included)
- SIZE HxW: 6.1" x 2.1" (155 x 53mm)
- WEIGHT: 7 oz (197g) with batteries





SPLASHFLASH™ LED HEADLAMP

The SplashFlash LED Headlamp is the perfect light for the trail or the water. Made of high-impact ABS plastic with a molded rubber lens protector, this waterproof headlamp features an adjustable strap for comfortable wear and a ratcheting head to direct light as needed.

- Unbreakable LED bulb provides 20 lumens of light for up to 8.5 hours
- Magnifier lens provides a focused beam
- Handy clip provides additional options to attach light
- Waterproof IPX7 (protected against water immersion for 30 minutes at 1 meter)

PART NUMBER	COLOR	UPC
20-12458	Gray	815608024583

- MODES: STEADY-ON>OFF>SOS FLASHING>OFF
- BATTERIES: 2 x CR2032 lithium batteries (included)
- SIZE HxWxD: 1.5" x 1.25" x 1.8" (38 x 32 x 46mm)
- WEIGHT: 1 oz (28g) with batteries

FEATURE	VALUE	UNIT
LUMENS	20	N/A
HOURS	8.5h	14h
WATERPROOF	1 METER	
PROTECTION	IPX7	



SPLASHFLASH™ LED LIGHT

- Unbreakable LED bulb provides 25 lumens of 360° light for up to 11 continuous hours
- Made of high-impact ABS plastic with a molded rubber lens protector
- Carabiner clip attaches anywhere or doubles as a keychain
- IPX7 (protected against water immersion for 30 minutes at 1 meter)
- MODES: STEADY-ON>SOS FLASHING>OFF

PART NUMBER	UPC	UPC
1146783	610	641120106517
1147296	Orange	641120106579

- BATTERIES: 1 x AAA battery (included)
- SIZE HxW: 3" x 1" (76 x 25mm)
- WEIGHT: 1 oz (28g) with batteries

MODE	STEADY-ON	SOS	WEIGHT
LUMENS	25 LUMENS	N/A	LED LIGHT 3x AAA
HOURS	11 HOURS	14 HOURS	BATTERY 3x AAA
WATERPROOF	1 METER		TOTAL WEIGHT 1.02
PROTECTION	IPX7		



TIGHT LIGHT 1.0 LED HEADLAMP

- Three unbreakable LED bulbs provide up to 30 lumens of bright light
- Runs up to 48 hours continuously on Low, and 10 hours on High
- Red light mode provides low-profile lighting
- Handy clip provides additional options to attach light

PART NUMBER	COLOR	UPC
20-HDL001-08	Orange	811747024316

- Adjustable cord for comfortable fit
- IPX6 (protected against storm water conditions from all directions)
- MODES: (White) LOW>HIGH>FLASHING>(Red) STEADY-ON>SOS FLASHING>OFF
- BATTERIES: 2 x CR2032 lithium batteries (included)
- SIZE HxWxD: 1.25" x 1.25" x 2" (32 x 32 x 25mm)
- WEIGHT: 1 oz (28g) with batteries

tools



JETSCREAM™ FLOATING WHISTLE

At 122dB, the JetScream Floating Whistle can be heard over most natural and man-made noises.

- Pox-less design won't rust, clog, or freeze—works in all weather conditions
- Compact, flat, and buoyant
- SIZE LxWxD: 2.25" x 1.3" x 0.5" (57 x 34 x 13mm)
- WEIGHT: 0.4 oz (10g)

PART NUMBER	COLOR	UPC
1156755	green	661120262989



HEAR-ME™ WHISTLE 2-PK

A waterproof, durable emergency whistle that emits a shrieking, high-pitched sound.

- Pox-less design won't rust, clog, or freeze—works in all weather conditions
- Includes breakaway lanyard and clip attachment for quick access
- SIZE LxWxD: 2.75" x 0.75" x 0.75" (70 x 19 x 19mm)
- WEIGHT: 0.3 oz (9g)

PART NUMBER	COLOR	UPC
20-02790	Yellow	811747027904



STARFLASH™ MICRO SIGNAL MIRROR

An ultralight, compact version of the StarFlash Floating Signal Mirror.

- SIZE LxWxD: 2" x 1.5" x 0.1" (51 x 38 x 3mm)
- WEIGHT: 0.3 oz (14g)

* NOTE: The StarFlash Micro is NOT a floating mirror.

PART NUMBER	COLOR	UPC
20-51120-101	-	812713016007



STARFLASH™ FLOATING SIGNAL MIRROR

Lightweight, virtually unbreakable signal mirror with a precision aiming system. Works even in overcast conditions or at night with moonlight or other light sources.

- Lanyard hole for attachment
- SIZE LxWxD: 3" x 2" x 0.25" (76 x 51 x 6mm)
- WEIGHT: 0.7 oz (20g)

PART NUMBER	COLOR	UPC
20-1WG6611	-	610390106116



PARACUDA™ PRO MACHETE

- Sturdy 11 in. (279mm) long, 3mm thick blade with a saw tooth edge for maximum cutting functionality
- Paratender Utility Cord handle wrap provides secure grip in all weather conditions and unwraps to provide over 9 ft. (2.7m) of paracord with an added single tinder thread
- Black-oxide finish reduces rust and protects the blade
- Protective sheath for safe storage included
- SIZE LxWxD: 16.3" x 2" x 1" (414 x 51 x 25mm)
- WEIGHT: 11.7 oz (331g) Paracuda only

PART NUMBER	COLOR	UPC
20-12239	Orange	815600022398



PARAKNIFE™ 4.0 PRO

- Durable 4 in. (102mm) long, 4mm thick stainless steel blade is handy to have on the trail
- Saw tooth blade adds maximum cutting functionality
- Paratender Utility Cord handle wrap provides secure grip in all weather conditions and unwraps to provide around 8 ft. (2.4m) of paracord with an added single tinder thread
- Black-oxide finish reduces rust and protects the blade
- Protective sheath for safe storage included
- SIZE LxWxD: 8.75" x 1.4" x 0.85" (222 x 36 x 22mm)
- WEIGHT: 4.7 oz (133g) Paraknife only

PART NUMBER	COLOR	UPC
20-12238	Orange	815600022381



PARAHATCHET™ PRO

- Stainless steel blade with quick-action rope cutter on back
- Multi-size hex wrenches (1/8", 3/16", and 1/4") can be safely accessed with sheath in place
- Paratender Utility Cord handle wrap provides secure grip in all weather conditions and unwraps to provide around 8 ft. (2.4m) of paracord with an added single tinder thread
- Black-oxide finish reduces rust and protects the blade
- Protective sheath for safe storage included
- SIZE LxWxD: 9.5" x 1.5" x 0.8" (241 x 89 x 20mm)
- WEIGHT: 9.8 oz (276g) Parahatchet only

PART NUMBER	COLOR	UPC
20-12237	Orange	815600022374



PARASHOVEL™ PRO

- A multi-tool shovel that includes a line cutter, saw blade, inch marks for measuring, cutting blade, and a tent peg pry
- Paratender Utility Cord handle wrap provides secure grip in all weather conditions and unwraps to provide around 8 ft. (2.4m) of paracord with an added single tinder thread
- Black-oxide finish reduces rust and protects the shovel
- Protective sheath for safe storage included
- SIZE LxW: 10" x 1.9" (254 x 48mm)
- WEIGHT: 5 oz (141g) Parashovel only

PART NUMBER	COLOR	UPC
20-12421	Orange	815600024248

PARACORD HANKS

100% nylon utility cord.

*NOTE: Not suitable for climbing.

- Ties out into threads for emergency fishing line, first aid, sewing thread, and more.
- Convenient carabiner included with each hank.

SIZE	LENGTH	WEIGHT
325	50 ft.	2.6 oz (74g)
550	30 ft.	2.2 oz (62g)
550	50 ft.	3.6 oz (102g)
550	100 ft.	7.2 oz (204g)



PARA 325 UTILITY CORD 50 FT.

PART NUMBER	LENGTH	COLOR	UPC
20-3C50-20	50 ft.	Black	815608021773
20-3C50-35	50 ft.	Orange	815608021797



PARA 325 REFLECTIVE UTILITY CORD

- Black paracord with reflective thread for increased visibility.

PART NUMBER	LENGTH	COLOR	UPC
20-3C50-25	50 ft.	Black/Reflective	815608021865



PARA 550 HEAVY DUTY CORD 30 FT.

PART NUMBER	LENGTH	COLOR	UPC
20-5C30-20	30 ft.	Black	815608021834
20-5C30-35	30 ft.	Orange	815608021858



PARA 550 HEAVY DUTY CORD 100 FT.

PART NUMBER	LENGTH	COLOR	UPC
20-5C100-20	100 ft.	Black	815608021803
20-5C100-08	100 ft.	Green Camo	815608021810
20-5C100-49	100 ft.	Assorted	815608021681



PARA 550 HEAVY DUTY CORD 50 FT.

PART NUMBER	LENGTH	COLOR	UPC
20-5C50-A12	50 ft.	Assorted	815608021674



PARA 1100 HEAVY DUTY CORD 30 FT.

PART NUMBER	LENGTH	COLOR	UPC
20-11C30-20	30 ft.	Black	815608022176



U-DIG-IT® FOLDING SHOVEL

Lightweight, versatile digging tool made of durable stainless steel.

- Folds for easy storage
- Useful for clearing rocks/debris, burying waste, plant removal, scaling fish, digging pits for campfires, and as a cooking utensil (can be heated)
- SIZE (blade) LxWxD: 5.25" x 2.2" x 1" (134 x 56 x 25mm)
- SIZE (shovel closed) LxWxD: 5.75" x 2.5" x 1" (146 x 65 x 25mm)
- SIZE (shovel open) LxWxD: 9" x 2.5" x 1.25" (233 x 65 x 32mm)
- WEIGHT: 5.2 oz (147g)

PART NUMBER	COLOR	UPC
1156920	Silver	661120262794



U-DIG-IT® LIGHT DUTY SHOVEL

The U-Dig-It Light Duty Shovel is the perfect backpacking tool for all of your outdoor excursions. Use at the campsite to clean up debris, bury pet or human waste, and more.

- Ultra-lightweight to reduce your pack weight
- Made of durable 7075-T6 aluminum
- Included carabiner to attach the shovel to your gear or belt
- SIZE LxWxD: 6.8" x 2.4" x 0.8" (173 x 61 x 20mm)
- WEIGHT: 0.6 oz (18g)

PART NUMBER	COLOR	UPC
20-12216	Orange	815601022169



CARABINER 10 CM

Great for any application where a quick, secure attachment is needed.

- 10cm spring-loaded, D-shaped carabiner
- Lightweight, strong, and durable
- Made of rust-resistant aluminum
- SIZE LxWxD: 4" x 2.3" x 0.4" (102 x 58 x 10mm)
- WEIGHT: 1.5 oz (43g)

* NOTE: Not suitable for climbing.

PART NUMBER	COLOR	UPC
20-02717	Silver	811747027171



ALUMINUM CARABINER

- Perfect when a lightweight, temporary attachment is needed
- Spring loaded, D-shaped carabiner
- SIZE LxWxD: 2.25" x 1.5" x 0.25" (57 x 38 x 6mm)
- WEIGHT: 0.3 oz (9g)

* NOTE: Not suitable for climbing.

PART NUMBER	COLOR	UPC
1156923	Black	661120262954



CARABINERS 8 CM, 2 PK

These spring-loaded, D-shaped carabiners are lightweight, strong and durable. Made of rust-resistant aluminum, our carabiners are great for all outdoor applications where a secure attachment is needed.

- SIZE LxWxD: 3" x 1.75" x 0.25" (76 x 44 x 6mm)
- WEIGHT: 0.6 oz (17g)

* NOTE: Not suitable for climbing.

PART NUMBER	COLOR	UPC
20-02115-PDQ12	Assorted	811747022534



WAYFINDING LEARN & LIVE™ KIT

The basic resources needed to learn to navigate outdoors.

- Learn & Live Wayfinding Cards: Reference guide outlining how to use a compass, map, and more, to navigate outdoors
- Waypoint Compass: A durable, liquid-filled compass for practicing navigation techniques
- SIZE HxWxD: 4.5" x 4" x 1.5" (114 x 102 x 38mm)
- WEIGHT: 4 oz (113g)

PART NUMBER	COLOR	UPC
20-02758	Gray	811747027584



KNOT TYING LEARN & LIVE™ KIT

Everything you need to learn and practice some of the most popular and useful knots applied outdoors.

- Learn & Live Knot Cards: Reference guide outlining step-by-step instructions to tie a variety of knots used outdoors
- 30 in. (762mm) card: Utility card to practice the various knots
- 6cm practice carabiner: Aluminum carabiner for attaching and practicing knots
- SIZE HxWxD: 4.5" x 4" x 1.5" (114 x 102 x 38mm)
- WEIGHT: 3.4 oz (96g)

PART NUMBER	COLOR	UPC
1145960	Blue	66120106708



FIRE STARTING LEARN & LIVE™ KIT

Includes all the tools you need to build a fire using a ferro rod and fire tinder.

- Learn & Live Fire Building Cards: Reference guide outlining step-by-step how to successfully build a fire
- SparkForce: A compact, high-performance ferro rod fire starter
- Light-Me™ Tinder (4): Small, fibrous fire starting tinder pieces
- SIZE HxWxD: 4.5" x 4" x 1.5" (114 x 102 x 38mm)
- WEIGHT: 4.4 oz (125g)

PART NUMBER	COLOR	UPC
20-02760	Gray	811747027607



OUTDOOR SKILLS LEARN & LIVE™ CARD SET

A collection of pocket reference guides covering the fundamentals of six imperative skills.

- Knot Tying Cards: Everything you need to learn and practice a variety of useful knots applied outdoors
- Wayfinding Cards: A pocket guide to learn how to navigate using maps, compasses, and more
- Survival Fishing Cards: Reference guide with step-by-step instructions for improvising gear and catching fish in an emergency situation
- Fire Building Cards: Outlines how to successfully build and start a fire outdoors
- First Aid Cards: Informative collection of tips on administering emergency first aid
- Shelter Building Cards: Detailed descriptions of various outdoor emergency shelters
- SIZE HxWxD: 4.5" x 4" x 1.5" (114 x 102 x 38mm)
- WEIGHT: 7.2 oz (204g)

PART NUMBER	COLOR	UPC
20-02752	Gray	811747027522



HI VIS™ LENSATIC MAP COMPASS

- Precise alignment and liquid compass for accurate readings
- Fluorescent green base plate enhances contrast to improve map reading
- Compact, folding design
- Features adjustable lens for dependable sighting
- Attached breakaway lanyard keeps compass handy
- SIZE LxWxD: 3.25" x 2.25" x 0.75" (83 x 57 x 19mm)
- WEIGHT: 2.0 oz (57g)

PART NUMBER	COLOR	UPC
20-12134	Hi Vis	815608021346



HI VIS™ DELUXE MAP COMPASS

- Fluorescent green base plate enhances contrast to improve map reading
- Liquid-filled compass keeps North arrow steady
- Rotating bezel
- Wagoner and route markers
- Extended base plate for improved map reading
- Multiple measurement scales for precise route planning
- Attached breakaway lanyard keeps compass handy
- SIZE LxWxD: 4.1" x 2.4" x 0.6" (104 x 61 x 15mm)
- WEIGHT: 1.4 oz (40g)

PART NUMBER	COLOR	UPC
20-12131	Hi Vis	815608021315



HI VIS™ FOLDING MAP COMPASS

The Hi Vis Folding Map Compass is one of the most reliable and versatile compasses, featuring a liquid interior and many useful features not found on standard compasses.

- Fluorescent green base plate enhances contrast to improve map reading
- Folding design with sighting mirror and slope indicator
- Swivel bezel
- SIZE LxWxD: 3.7" x 2.5" x 0.7" (94 x 64 x 18mm)
- WEIGHT: 2.3 oz (65g)

PART NUMBER	COLOR	UPC
20-12132	Hi Vis	815608021322



HI VIS™ WAYPOINT MAP COMPASS

- Fluorescent green base plate enhances contrast to improve map reading
- Liquid-filled compass keeps North arrow steady
- Multiple measurement scales for precise route planning
- Attached breakaway lanyard keeps compass handy
- SIZE LxWxD: 3.5" x 2.5" x 0.6" (89 x 64 x 15mm)
- WEIGHT: 1.1 oz (31g)

PART NUMBER	COLOR	UPC
20-12133	Hi Vis	815608021308



FOLDING MAP COMPASS

Liquid-filled folding compass with sighting mirror and slope indicator.

- Adjustable declination feature with screwdriver and lanyard included
- Clear base plate and swivel bezel for easy map reading
- Rugged, 5mm thick base
- SIZE LxWxD: 4" x 2.5" x 0.75" (102 x 64 x 19mm)
- WEIGHT: 2.4 oz (68g)

PART NUMBER	COLOR	UPC
20-02149-12	Black	811747021490



LENSATIC COMPASS

A compact, folding compass with luminous navigation points.

- Precision alignment and liquid compass for accurate readings
- Shock-resistant case
- SIZE LxWxD: 3" x 2" x 1" (76 x 51 x 25mm)
- WEIGHT: 2 oz (57g)

PART NUMBER	COLOR	UPC
20-310-0C45	Black	812713015710



DELUXE MAP COMPASS

Liquid-filled compass with swivel bezel and magnifier.

- Extended, clear base plate for improved map reading
- Multiple measuring scales for precise route planning
- Adjustable marching line
- Breakaway lanyard included
- SIZE LxWxD: 5" x 2.4" x 0.6" (128 x 60 x 16mm)
- WEIGHT: 1.8 oz (51g)

PART NUMBER	COLOR	UPC
20-310-455C	-	812713017219



WAYPOINT COMPASS

Liquid-filled compass with clear base plate and magnifier.

- Multiple measuring scales for precise route planning
- Adjustable marching line
- Breakaway lanyard included
- SIZE LxWxD: 3" x 2.3" x 0.25" (76 x 58 x 6mm)
- WEIGHT: 0.8 oz (23g)

PART NUMBER	COLOR	UPC
20-310-351	-	812713015444

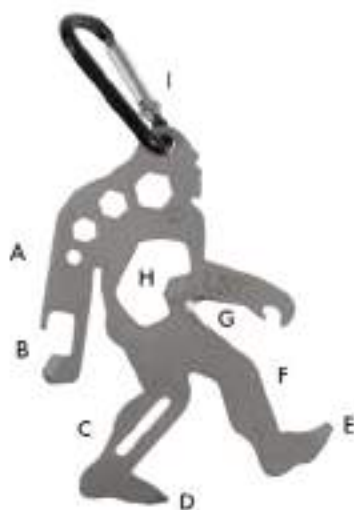

TOOL A LONG, SASQUATCH

The *ust* Tool a Long stainless steel multi-tool is pocket-sized and designed to accomplish a variety of tasks outdoors or on the go. The included carabiner makes it easily accessible on your gear, belt, bag, and more. TSA-compliant for safe travel.

- A. Hex Wrench (4 positions)
- B. Can Opener
- C. Butterfly Wrench
- D. Flat Head Screwdriver
- E. Phillips Head Screwdriver
- F. 1" ruler
- G. Cord Cutter
- H. Bottle Opener
- I. 1.5" Carabiner

- SIZE LxWxD: 3.6" x 2.5" x 0.1" (91 x 64 x 3mm)
- WEIGHT: 1.2 oz (34g)

PART NUMBER	COLOR	UPC
20-02989	Titanium	811747025892



TOOL A LONG, MOOSE

The *ust* Tool a Long stainless steel multi-tool is pocket-sized and designed to accomplish a variety of tasks outdoors or on the go. The included carabiner makes it easily accessible on your gear, belt, bag, and more. TSA-compliant for safe travel.

- A. 1.5" Carabiner
- B. Bottle Opener
- C. Hex Wrench (3 positions)
- D. Cord Cutter
- E. Phillips Head Screwdriver
- F. Butterfly Wrench
- G. Flat Head Screwdriver

- SIZE LxWxD: 3.2" x 3.2" x 0.1" (81 x 81 x 3mm)
- WEIGHT: 1.3 oz (37g)

PART NUMBER	COLOR	UPC
20-02763	Titanium	811747027638

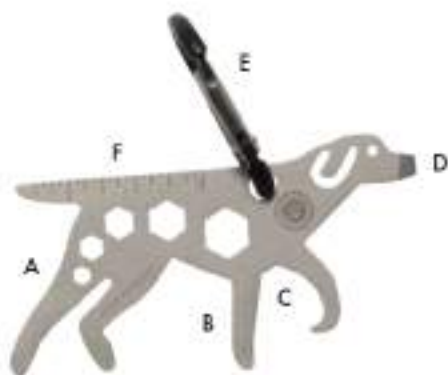

TOOL A LONG, DOG

The *ust* Tool a Long stainless steel multi-tool is pocket-sized and designed to accomplish a variety of tasks outdoors or on the go. The included carabiner makes it easily accessible on your gear, belt, bag, and more. TSA-compliant for safe travel.

- A. Hex Wrench (5 positions)
- B. File
- C. Bottle Opener
- D. Flat Head Screwdriver
- E. 1.5" Carabiner
- F. 1.25" ruler

- SIZE LxWxD: 3.25" x 1.5" x 0.1" (83 x 38 x 3mm)
- WEIGHT: 0.8 oz (23g)

PART NUMBER	COLOR	UPC
20-02756	Titanium	811747027560



SEE-ME™ LIGHT STICKS

Weatherproof light sticks provide up to 12 hours of glowing light.

- Easily attach to tents, boats, or anywhere you need them with the integrated hook or included lanyard
- Contents are non-flammable
- Assorted colors
- SIZE LxW: 6" x 0.75" (152 x 19mm) each
- WEIGHT: 1 oz (27g) each

PART NUMBER	SIZE	UPC
20-310-110	6"	812713015123



TEKFIRE™ CHARGE FUEL-FREE LIGHTER

The lightweight and compact TekFire Charge Fuel-Free Lighter allows for quick and easy fire starting and features an emergency power bank to charge your phone and other small electronic devices on the go. Windproof, flameless, and electronic, it requires no battery-fuel or adjustments for altitude. The included ParaTinder Utility Cord wrist lanyard can be unwound for about 3 ft. (0.9m) of all-purpose paracord with an added single tinder thread. The lighter also comes with a USB cord for easy recharging from any USB port.

- No fuel needed, no flame
- Power bank and lighter work independently, powered by USB-rechargeable 3,000 mAh lithium-ion battery
- Recharges fully in approximately 3 hours
- To operate lighter, release wire safety catch and press black button to open lid

hold down front power button

- Blue indicator lights show the charge level of the lighter and power bank; lights flash blue when charging and all four lights are solid blue when fully charged
- Lighter has 10 second time-out safety feature
- To ignite ParaTinder Utility Cord, expose red core thread and light with the TekFire Charge Fuel-Free Lighter
- Use inner paracord strands for sewing thread, sutures, fishing line, and more
- Lighter will last for thousands of ignitions
- SIZE (HxWxD): 5.5" x 1.2" x 1.2" (140 x 31 x 31mm)
- WEIGHT: 4 oz (113g)

PART NUMBER	COLOR	UPC
1142747	Blue	66120106423



TEKFIRE™ PRO FUEL-FREE LIGHTER

The lightweight, compact TekFire PRO Fuel-Free Lighter allows for quick and easy fire starting. Windproof, flameless and electronic, it requires no butane fuel or adjustments for altitude. Lighter comes with a USB cord for easy recharging from any USB port.

- Built-in, rechargeable lithium-ion battery
- 10 second time-out safety feature
- Paralinder Utility Cord lanyard can be unwound for about 3 ft. (0.9m) of cord
- To ignite Paralinder Utility Cord, expose red core thread and light with the TekFire PRO Fuel-Free Lighter or any other fire starter
- Use inner paracord strands for sewing thread, sutures, fishing line, and more
- Capacity: 300mAh
- SIZE HxWxD: 3" x 1.5" x 0.8" (76 x 38 x 20mm)
- WEIGHT: 1.9 oz (54g)

PART NUMBER	COLOR	UPC
1142734	Blue	661120106661



TEKFIRE™ LED FUEL-FREE LIGHTER

The lightweight and compact TekFire LED Fuel-Free lighter allows for quick and easy fire starting and features a bright LED light. Windproof, flameless, and electronic, it requires no butane fuel or adjustments for altitude. The lighter also comes with a USB cord for easy recharging from any USB port.

- Built-in, rechargeable lithium-ion battery
- LED light and lighter work independently
- Press power button twice to turn on light
- Indicator light flashes red while charging and is solid red when fully charged
- 10 second time-out safety feature
- Paralinder Utility Cord lanyard can be unwound for about 3 ft. (0.9m) of cord
- To ignite Paralinder Utility Cord, expose red core thread and light with the TekFire LED Fuel-Free Lighter
- Use inner paracord strands for sewing thread, sutures, fishing line, and more
- SIZE HxWxD: 3" x 1.5" x 0.9" (76 x 38 x 23mm)
- WEIGHT: 2.1 oz (60g)

PART NUMBER	COLOR	UPC
28-12425	Grey	815600024255



LIGHT-ME™ TINDER

Small, cotton-based tinder pieces that are perfect for starting fires outdoors. For best results, tear open to expose the fibers inside before lighting.

- Provides 2-3 minutes of burn time per piece
- Specially-treated fibers will light even in damp conditions
- Works well with any wet fire starter
- Heritage pack includes vintage storage tin
- SIZE LxW: 1.25" x 0.4" (32 x 10mm) each
- WEIGHT: >0.1 oz (3g) each

PART NUMBER	SIZE	UPC
20-020333-02	8-pk	811747020332



WATERPROOF MATCHES 4-PK

A classic investment for camping and emergency situations. Waterproof matches and box striking surface are effective when damp or wet. Extra-large match heads light with ease.

- Includes 4 boxes containing 40 waterproof matches per box
- SIZE LxWxD: 2.25" x 1.5" x 0.5" (57 x 38 x 13mm) one box
- WEIGHT: 1.5 oz (43g)

PART NUMBER	UPC
20-02118-02	811747021186



WETFIRE™ TINDER

Universal lighting material that is safe, lightweight, easy to carry and guaranteed to light in windy or wet conditions. Only a small amount is required to start a fire. Shave off a small piece or use the entire cube depending on the level of wind or moisture.

- Extinguishes instantly
- Cubed tinders are individually packed to maintain freshness
- Will burn longer when wet or moist
- Great for use with any wet fire starter
- 5-year shelf life
- SIZE HxWxD: 0.75" x 0.75" x 0.5" (19 x 19 x 13mm)
- WEIGHT: 0.16 oz (5g) each

PART NUMBER	SIZE	UPC
20-TWG0412-8XS	5-pk	812713013945
20-TWG0412	8-pk	610390364123
20-TWG0412-8X12	12-pk	812713013938



FIRE STIX™ 12-PK

Quick and convenient tinder sticks for starting fires. Will light even when wet.

- 12 sticks per box
- Non-toxic and odorless
- SIZE LxWxD: 4.8" x 0.5" x 0.5" (122 x 13 x 13mm) each
- WEIGHT: 0.4 oz (11g) each

PART NUMBER	SIZE	UPC
1146775	12-pk	66120106531



STOKE KIT

A quick and convenient fire starter kit for campfires and emergency situations. The BASE Case 1.0, with o-ring seal, keeps all of the components dry until you need them.

- A. BASE Case 1.0: O-ring sealed, water-resistant container
- B. Micro SparkWheel™ Fire Starter: Includes 3 replacement flints
- C. Light-Me™ Tinder: 2 pieces

- SIZE HxW: 3" x 1" (76 x 25mm)
- WEIGHT: 1.3 oz (37g)

PART NUMBER	COLOR	UPC
1156913	Blue	661120262735



MAGBAR™ FIRE STARTER

Tried and true, the MagBar Fire Starter combines magnesium shavings and the sparks of a flint to start the fire you desperately need. Use the serrated edge to shave off magnesium into a pile. Use the other edge to strike the flint bar and create sparks.

- Reliably starts hundreds of fires
- Shaver/striker included
- SIZE LxWxD: 3.1" x 1.1" x 0.4" (79 x 29 x 10mm)
- WEIGHT: 1.8 oz (50g)

PART NUMBER	COLOR	UPC
20-310-251	—	812713014437



SPARKIE™ FIRE STARTER

Developed on the premise that one arm has been injured or immobilized, the Sparkie Fire Starter is a unique and patented flint-based fire starter that can be operated with one hand. It generates an intense amount of sparks with minimal effort, will light over 100 fires, and works when wet.

- Designed for precision—sparks can be directionally targeted
- Generates sparks three times better than a normal match
- SIZE (closed) LxWxD: 2.3" x 1.25" x 0.6" (58 x 32 x 15mm)
- WEIGHT: 0.8 oz (23g)

PART NUMBER	COLOR	UPC
20-902-0003-001	Orange	811747025016



SPARKFORCE™ FIRE STARTER

A compact, lightweight ferro rod that produces a shower of hot sparks to light fires outdoors.

- Striker is built into the detachable cap to protect flint and prevent unintended sparks
- Ignites a wide variety of tinder, including ast WetFire™ Tinder
- A great addition to micro survival kits or small camping bags
- SIZE (closed) LxWxD: 3.1" x 0.75" x 0.4" (79 x 19 x 10mm)
- WEIGHT: 1 oz (28g)

PART NUMBER	COLOR	UPC
20-310-259	Orange	812713016045



BLASTMATCH™ FIRE STARTER

Developed on the premise that one arm has been injured or immobilized, the BlastMatch Fire Starter is a unique flat-based fire starter that can be operated with one hand. It generates an intense amount of sparks with minimal effort, will last up to 4,000 strikes, and works when wet.

- Ignites a wide range of tinder including our WetFire™ Tinder
- Sparks can be directionally targeted
- Works in rain and other adverse weather conditions
- Rotates 360° for even wear
- Safety button prevents accidental sparks
- SIZE (closed) LxWxD: 4.1" x 1.4" x 1" (105 x 35 x 25mm)
- WEIGHT: 2.3 oz (65g)

PART NUMBER	COLOR	UPC
20-900-0014-001	Black	811747022565



STRIKEFORCE™ FIRE STARTER WITH TINDER

An all-weather fire starting tool that creates an abundance of extremely hot sparks. It will last up to 4,000 strikes.

- Includes 2 pieces of Light-We™ Tinder in storage compartment
- Ignites a wide range of tinder
- Striker is built into the detachable cap to protect the ferro rod and prevent unintended sparks
- SIZE (closed) LxWxD: 5" x 1.5" x 1" (127 x 38 x 25mm)
- WEIGHT: 3.7 oz (105g)

PART NUMBER	COLOR	UPC
20-12147	Orange	815600021476



PARATINDER™ UTILITY CORD

Paratinder Utility Cord is an amazing innovation in emergency preparedness. It combines life-saving fire tinder and heavy-duty 550 paracord for the ultimate gear duo. The addition of a single tinder thread allows this paracord to pull double duty.

- To ignite, expose red core thread and light with any fire starter
- Create bracelets, zipper pulls, handle wraps, and lanyards for emergency situations
- Tinder core threads can be used as sewing thread, sutures, fishing line, and more

30ft:

- LENGTH: 30 ft. (9.1m)
- WEIGHT: 3 oz (85g)

100ft:

- LENGTH: 100 ft. (30.1m)
- WEIGHT: 9.6 oz (272g)

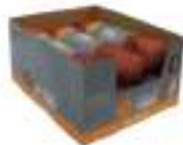

PART NUMBER	SIZE	COLOR	UPC
20-02295	30 ft.	Orange/Grey	811747027950
20-08043	100 ft.	Orange/Grey	815600020189



FLEXWARE® BUCKET

With its unique collapsible design, this bucket takes up minimal space when packed or stored.

- Reinforced plastic rim with pouring groove and built-in storage hook
- Convenient fold-down handle
- Perfect for carrying water, gear, or other small items
- SIZE (expanded) HxW: 7.75" x 10" (197 x 254mm)
- WEIGHT: 12.6 oz (357g)
- CAPACITY: 1.3 gal (5L)

PART NUMBER	COLOR	UPC
20-02078-08	Orange	811747025450

FLEXWARE® BUCKET 2.0

- SIZE (expanded) HxW: 9" x 12" (229 x 305mm)
- WEIGHT: 22.3 oz (632g)
- CAPACITY: 2.6 gal (10L)

PART NUMBER	COLOR	UPC
20-12262	Orange	815608022671

FLEXWARE® SINK

Washing dishes at the campsite won't be a problem when you bring the FlexWare Sink along on the trip. Featuring a collapsible TPR body, it takes up minimal space and stores easily when not in use.

- Dual carrying handles make it easy to move when filled
- Sturdy, plastic rim and base provide additional support
- Doubles as a carrying basket
- Dishwasher safe
- SIZE (expanded) HxWxD: 15" x 11.4" x 5.9" (381 x 290 x 150mm)
- WEIGHT: 19.7 oz (557g)
- CAPACITY: 2.25 gal (8.5L)

PART NUMBER	COLOR	UPC
1142757	Orange	661120106630

FLEXWARE® SINK 2.0

- SIZE (expanded) HxWxD: 16" x 13.5" x 7" (417 x 343 x 178mm)
- WEIGHT: 30.4 oz (863g)
- CAPACITY: 4.2 gal (16L)

PART NUMBER	COLOR	UPC
1145919	Orange	661120106678





FLEXWARE® COFFEE DRIP

Brew hot, fresh coffee with the new FlexWare Coffee Drip. To use, put your paper filter inside, add coffee, and place on top of your favorite coffee mug. Pour hot water over the coffee grounds and wait a minute or two.

- Sleek design saves space and makes storage a breeze
- Perfect for RV, camping, or backpacking
- Easy-to-use and easy-to-clean
- Does not absorb odors or pass on chemical tastes into your brew
- Dishwasher safe
- SIZE (expanded) HxW: 3.25" x 4.5" (83 x 114mm)
- WEIGHT: 3.6 oz (102g)

PART NUMBER	COLOR	UPC
20-CKT0019-08	Orange	811747025702



FLEXWARE® BOWL 1.0

The FlexWare Bowl 1.0 is easy-to-store and easy-to-use.

- Flexible rim for easy pouring
- Made of heat-resistant, food-grade silicone
- Can withstand temperatures up to 300° F (149° C)
- Dishwasher and microwave safe
- SIZE (expanded) HxW: 2.25" x 5.5" (57 x 140mm)
- WEIGHT: 2.8 oz (79g)
- CAPACITY: 16.9 fl oz (500ml)

PART NUMBER	COLOR	UPC
1149162	Orange	661120260448



FLEXWARE® BOWL 2.0

The FlexWare Bowl 2.0 is easy-to-store and easy-to-use.

- Rigid rim for secure handling
- Made of heat-resistant, food-grade silicone
- Can withstand temperatures up to 300° F (149° C)
- Dishwasher and microwave safe
- SIZE (expanded) HxW: 4" x 5" (102 x 127mm)
- WEIGHT: 3.8 oz (108g)
- CAPACITY: 24 fl oz (710 ml)

PART NUMBER	COLOR	UPC
1149170	Orange	661120260455



FLEXWARE® MESS KIT

The premium solution for hungry hikers and campers. This kit features a lightweight, collapsible silicone construction with two roomy compartments and a reusable fork and spoon combo that is integrated into the lid.

- Durable plastic rim provides additional support when expanded
- Withstands temperatures up to 212° F (100° C)
- Made of FDA-approved materials
- Dishwasher and microwave safe
- SIZE (expanded) HxWxD: 2.75" x 8.4" x 5.9" (70 x 213 x 149mm)
- WEIGHT: 10.4 oz (295g)

PART NUMBER	COLOR	UPC
1146792	Orange	661120262817



FLEXWARE® TUB

The FlexWare Tub is strong, durable, and flexible. With its unique collapsible design, this tub takes up minimal space when packed or stored.

- Reinforced with a plastic rim and base for extra stability
- Can be used as a large sink, laundry basket, or carry-all
- SIZE HxWxD: 10.5" x 24" x 17.5" (266 x 609 x 445mm)
- CAPACITY: 9.7 gal (37L)
- WEIGHT: 2.9 lbs (1.3kg)

PART NUMBER	COLOR	UPC
20-12566	Orange	815608025665



FLEXWARE® BOIL & STORE BAGS 2-PK

Conveniently store leftovers or snacks in FlexWare Boil & Store Bags. Eco-friendly alternative to plastic zip bags, these sturdy, reusable storage bags are durable and leak-proof. Use to cook freeze-dried meals or warm up leftovers.

- Imprinted measurements make it easy to measure liquids
- Included carabiner for quick and easy attachment to gear
- SIZE HxWxD: 6.9" x 9.1" x 1.2" (175 x 233 x 30mm) each
- WEIGHT: 4.8 oz (280g) each

PART NUMBER	COLOR	UPC
20-12562	Orange	815608025627



FLEXWARE® SWEEP SET

The last FlexWare Sweep Set is a simple and compact cleaning solution. Perfect for quick cleanups at the campsites, on your boat, in your RV, and more.

- Brush clicks onto dust pan for compact storage
- Dust pan lays flat when not in use; fold up sides to clean up messes
- SIZE LxWxD: 6.3" x 7" x 0.5" (160 x 178 x 13mm)
- WEIGHT: 2.5 oz (71g)

PART NUMBER	COLOR	UPC
1147664	Orange	661120107293



KLIPP™ SPORK & SPATULA

The *use* KLIPP Spork & Spatula set features a handy spoon and fork combo, and an innovative spatula with serrated knife edge.

- Durable and lightweight
- Easily attaches to backpack or other gear for easy accessibility
- BPA free, dishwasher safe, and stain-resistant
- SIZE (Spork) LxWxD: 6.6" x 1.5" x 0.4" (168 x 38 x 10mm)
- SIZE (Spatula) LxWxD: 6.75" x 1.5" x 0.1" (171 x 38 x 3mm)
- WEIGHT: 0.2 oz (6g) Spork, 0.4 oz (11g) Spatula

PART NUMBER	COLOR	UPC
20-12148	Orange	815608021483



KLIPP™ UTENSIL SET

The KLIPP Utensil Set is made of extremely tough stainless steel. It features a smooth matte-metallic finish and is durable enough to last a lifetime.

- Locking container keeps utensils together during storage
- SIZE LxWxD: 6.25" x 1.5" x 0.75" (159 x 38 x 19mm)
- WEIGHT: 1.2 oz (62g)

PART NUMBER	COLOR	UPC
1146787	-	661120106562



KLIPP™ SPORK 4-PK

The *use* KLIPP Spork is a handy spoon and fork combo that is perfect for meals with friends and family at the campsite.

- Durable and lightweight
- Easily attaches to backpack or other gear for easy accessibility
- BPA free, dishwasher safe, and stain-resistant
- SIZE LxWxD: 6.4" x 1.5" x 0.4" (168 x 38 x 10mm) each
- WEIGHT: 0.2 oz (6g) each

PART NUMBER	COLOR	UPC
20-12408	Multi	815608024088



KLIPP™ SERVING SET

The *use* KLIPP Serving Set includes a handy spoon and fork combo, and an innovative spatula with serrated knife edge. These larger utensils are perfect for serving a meal at the campsite.

- Easily attaches to backpack or other gear for easy accessibility
- BPA-free, dishwasher safe, and stain-resistant
- SIZE (Spork) LxWxD: 10" x 2.2" x 0.25" (254 x 56 x 6mm)
- SIZE (Spatula) LxWxD: 10" x 2.3" x 0.75" (254 x 58 x 19mm)
- WEIGHT: 1 oz (28g) Spork, 1.5 oz (43g) Spatula

PART NUMBER	COLOR	UPC
20-12407	Orange	815608024071

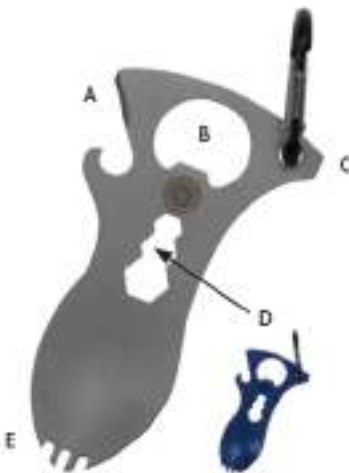

SPORK MULTI-TOOL

The stainless steel *use* Spork Multi-Tool has you covered at meal time or when you need a fast repair. Carabiner included for quick and easy attachment to your gear, belt, or bag.

- A. Can Opener
- B. Bottle Opener
- C. Flat Head Screwdriver & Pry Tip
- D. Hex Wrench (3 positions)
- E. Spork
- SIZE LxWxD: 4" x 2.1" x 0.6" (201 x 54 x 16mm)
- WEIGHT: 1.2 oz (34g)

PART NUMBER	COLOR	UPC
20-MTL006-02	Titanium	811747024644
20-02198	Blue	815608021988



UTILITENSIL SET

Our corrosion resistant, stainless steel utensil set is lightweight and built to last a lifetime. Includes convenient carrying case.

- Open bottles and make measurements with the integrated bottle opener and ruler on the handle of the spoon
- Fork handle features a can opener and multi-size hex wrench
- Butterfly wrench integrated into the handle of the knife
- SIZE LxWxD: 7" x 1.75" x 1" (178 x 45 x 25mm)
- WEIGHT: 2.9 oz (82g)

PART NUMBER	COLOR	UPC
20-02796	-	811747027966



PACKWARE™ DISH SET

The PackWare Dish Set includes a plate, bowl, mug, and utensils in a convenient mesh bag.

- Made of lightweight, flexible polypropylene
- Easy to pack and store in mesh bag
- Durable, easy to clean, reusable, and recyclable
- SIZE LxWxD: 12" x 10" x 3.5" (305 x 254 x 89mm)
- WEIGHT: 7.2 oz (204g)

PART NUMBER	COLOR	UPC
1142261	blue	661120106647



PACKWARE™ MESS KIT

The PackWare Mess Kit is the all-in-one outdoor dining package. Cut, chop, strain, pour, sip, and save meals with ease.

- Includes cup with handle, lid and bottom that serve as meal bowls, cutting board/strainer, and eating utensils (fork, knife, spoon)
- Made of durable, BPA-free plastic
- Dishwasher and microwave safe
- SIZE HxWxD: 2.2" x 5" x 6.9" (56 x 127 x 175mm)
- WEIGHT: 8.1 oz (230g)

PART NUMBER	COLOR	UPC
20-02734	Orange	811747027348



PICNIC SET

Our 16-piece Picnic Set will brighten up any meal on the trail or at the campsite. This lightweight and durable set contains four stackable plates along with four forks, four knives, and four spoons.

- 7 in. diameter plates
- BPA-free
- Dishwasher and microwave safe
- SIZE LxWxD: 7.4" x 7.4" x 1" (188 x 188 x 25mm)
- WEIGHT: 4.8 oz (135g)

PART NUMBER	COLOR	UPC
20-02781	Orange	811747027812



MICROFIBER TOWELS

- Super absorbent microfiber is lightweight and durable
- Ideal for personal care needs during outdoor activities or at the campsite
- Wicks water more effectively than regular, bulky towels
- Packs conveniently in its own zippered pouch
- Gently machine wash if needed, then air dry
- Material contents: 88% Polyester, 12% Polyamide

ITEM	SIZE LxW	WEIGHT
Microfiber Towel 1.0	20" x 16" (508 x 406mm)	2.4 oz (68g)
Microfiber Towel 2.0	20" x 48" (508 x 1016mm)	5.1 oz (146g)

PART NUMBER	COLOR	UPC
20-CCR0308-08	1.0 Orange	811747025344
20-CCR0309-08	2.0 Orange	811747025351



TREKKER™ STOVE

The Trekker Stove is ideal for hiking and backpacking due to its compact size and light weight. Works with isobutane-propane fuel (not included) and includes a fuel stand for additional stability.

- A. Burner, push button ignition C. Fuel canister (not included)
 B. Flame adjustment control D. Fuel canister stabilizer

- Easy-to-use push button ignition
- Sealed pot supports collapse for compact storage
- SIZE (opened) HxW: 5.4" x 4.2" (86 x 107mm)
- SIZE (folded) HxW: 2.8" x 2.2" (71 x 56mm)
- WEIGHT: 2.8 oz (79g) stove / 4.0 oz (113g) with stand

PART NUMBER	COLOR	UPC
20-12558	Orange	815608025580

DUO COOK KIT

The Duo Cook Kit is the ultimate compact dining package for people on the go. It is a great choice for multi-day hikers and campers who want to save space and carry less. The boxes double as pots that you can use for making tasty meals on the trail, and the lids function as convenient bowls.

- Hard, anodized aluminum construction
- Volume measurements embossed on sides
- Plastic-coated, foldable handles save space in packs and protect from burns

PART NUMBER	COLOR	UPC
20-12563	-	815608025634

- Easy to clean
- Drying mesh bag included
- CAPACITY:
 Large Pot: 43.9 fl. oz. (1.3L)
 Large Bowl: 20.2 fl. oz. (600ml)
 Small Pot: 30.4 fl. oz. (900ml)
 Small Bowl: 13.5 fl. oz. (400ml)
- WEIGHT: 15.8 oz (448g)



SOLO COOK KIT

The Solo Cook Kit is the ultimate compact dining package. It is a great choice for ultralight or multi-day hikers and campers who are weight-focused and want to save space.

- Hard, anodized aluminum construction
- Volume measurements embossed on sides
- Silicone-coated, foldable handles save space and protect from burns
- Dishwasher safe and BPA-free
- Drying mesh bag included for easy packing and transport
- SIZE HxW: 5.2" x 4.2" (132 x 107mm)
- WEIGHT: 7.1 oz (201g)

PART NUMBER	COLOR	UPC
20-02743	Orange	811747027430



KLIPP™ BINER MUG 1.0

The Klipp Biner Mug 1.0 features an 8cm orange carabiner handle for added functionality. Great for clipping to backpacks or other kitchen gear.

- Food-grade stainless steel
- Double wall construction for insulation
- Rolled rim for comfortable sipping
- SIZE HxWxD: 3.5" x 4.75" x 3" (89 x 121 x 76mm)
- WEIGHT: 3.8 oz (108g)
- CAPACITY: 9 fl oz (270ml)

PART NUMBER	COLOR	UPC
20-02059-02	-	811747025511



KLIPP™ BINER MUG 1.0 4-PK

The Klipp Biner Mug 1.0 features an 8cm carabiner handle, in assorted colors, for added functionality. Great for clipping to backpacks or other kitchen gear.

- Food-grade stainless steel, rolled rim for comfortable sipping
- Double wall construction for insulation
- SIZE HxWxD: 3.5" x 4.75" x 3" (89 x 121 x 76mm) each
- WEIGHT: 3.8 oz (108g) each
- CAPACITY: 9 fl oz (270ml)

PART NUMBER	COLOR	UPC
20-12564	-	815608025641



WATER CARRIER CUBE 5-GAL

Folds flat for compact storage and transport

- Heavy-duty polyethylene carrier resists dents and cracks
- On/Off spigot easily detaches for quick fills
- Opening is large enough to add ice cubes
- SIZE (filled) HxWxD: 12" x 9" x 10" (304 x 229 x 254mm)
- SIZE (rolled up) HxWxD: 3" x 9" x 10" (76 x 229 x 254mm)
- WEIGHT: 10.4 oz (295g)

PART NUMBER	COLOR	UPC
20-02134-10	Clear	811747021346



ROLL-UP WATER CARRIER 10L

Hang this water carrier from a tree or clothes line for easy access to water for drinking, washing, or bathing.

- Sturdy, wooden handles support carrier when full
- One-handed operation spout
- Holds 10L of water
- SIZE HxWxD: 24" x 11.5" x 1.5" (610 x 292 x 38mm)
- WEIGHT: 8.6 oz (244g)

PART NUMBER	COLOR	UPC
20-02131-10	Clear	811747021315



PACK A LONG™ GRILL

The easy-to-assemble *ust* Pack a Long Grill is perfect for camping, hiking, RVs, and anywhere you want to grill but have a limited amount of space.

- Disassembles and collapses for convenient, flat storage
- Can be used with a variety of fuels, including charcoal and wood
- SIZE (opened) HxWxD: 8.4" x 12.4" x 12.7" (213 x 315 x 310mm)
- SIZE (folded) HxWxD: 13.5" x 7.2" x 1.8" (343 x 183 x 46mm)
- WEIGHT: 4 lbs 1.4 oz (1.8kg)

PART NUMBER	COLOR	UPC
20-12565	Silver	815688025658



PACK A LONG™ CAMP TABLE

The Pack a Long Camp Table is waterproof, weather-resistant, and easy-to-clean. Lightweight and easy-to-store, this aluminum table provides a stable surface for mealtime or other camp activities.

- Table top folds and legs collapse for compact storage with included stuff sack
- Quick, simple set up
- SIZE HxW: 22.1" x 16" (561 x 406mm)
- CAPACITY: 30 lbs (13.6kg)
- WEIGHT: 2 lbs 9.6 oz (1.2kg)

PART NUMBER	COLOR	UPC
20-12580	Copper	815688025801



PEG MALLET GLO

Designed to easily strike and pull stubborn steel or plastic tent pegs.

- Heavy-duty, high-impact plastic construction
- Great for setting up camp in the dark
- Glows in the dark after exposure to sunlight or other light sources
- SIZE LxWxD: 12.5" x 3.4" x 2.1" (318 x 86 x 54mm)
- WEIGHT: 7.4 oz (210g)

PART NUMBER	COLOR	UPC
1146764	GLO	661120260462



TENT BULB LED 1.0

Unique bulb design is a stylish and effective way to light your tent at night with a soft, diffused light.

- 4 Modes: HIGH>LOW>FLASHING>SOOTHING AMBER NIGHTLIGHT>OFF
- Produces 40 lumens of light on High
- Long-lasting LED bulbs
- Handy carabiner included for hanging in tents, on a branch or post, or attaching to gear
- BATTERIES: 1 x AA (included)
- SIZE HxW: 5.5" x 2.25" (140 x 57mm)
- WEIGHT: 2.8 oz (79g) with battery

PART NUMBER	COLOR	UPC
1142762	-	661120106500



BAMBOO DINNER SET

Our 14-piece Bamboo Dinner Set is an eco-friendly alternative to plastic and will lighten up any meal on the trail or at the campsite. This lightweight and durable set contains four stackable plates along with four forks, four knives, and four spoons. Multi-use bamboo plates and utensils can also be used as tinder in an emergency.

- **SIZE LxW:**
 Plate: 10" x 10" (254 x 254mm)
 Fork: 6.7" x 1.0" (170 x 25mm)
 Spoon: 6.7" x 1.2" (170 x 30mm)
 Knife: 6.7" x 0.8" (170 x 20mm)
- **WEIGHT:** 2.6 oz (74g)

PART NUMBER	COLOR	UPC
20-12573	-	815608025733



BAMBOO UTENSIL 12-PIECE SET

The *ust* Bamboo Utensil Set is an eco-friendly alternative to plastic. Multi-use bamboo plates and utensils are perfect for all of your adventures and can be used as tinder in an emergency. Set includes four forks, four spoons and four knives.

- **SIZE LxW:**
 Fork: 6.7" x 1.0" (170 x 25mm)
 Spoon: 6.7" x 1.2" (170 x 30mm)
 Knife: 6.7" x 0.8" (170 x 20mm)
- **WEIGHT:** 4 oz (11g) for set of 1 fork, 1 knife, 1 spoon

PART NUMBER	COLOR	UPC
20-12574	-	815608025740



BAMBOO CUTTING BOARD 2.0

The *ust* Bamboo Cutting Boards are an eco-friendly alternative to plastic. Bamboo is a dense, non-porous grass that resists moisture and is less likely to bend, warp, or crack.

- Sturdy surface holds up to chopping and slicing
- Compact, space-saving size for easy transport
- **SIZE HxWxD:** 11.8" x 8.8" x 0.4" (300 x 224 x 10mm)
- **WEIGHT:** 15 oz (425g)

PART NUMBER	COLOR	UPC
20-12592	-	815608025924



BRILA™ USB RECHARGEABLE FAN & LIGHT 1.0

The 1st Brila USB Rechargeable Fan & Light 1.0 is compact, lightweight and USB rechargeable. Compact, convenient portable fan with built-in light has an integrated handle and pop-out hook for hanging.

- USB rechargeable
- Fan and light work independently
- FAN MODES: LOW>HIGH>OFF
- LIGHT MODES: ON>OFF
- SIZE HxW: 5.7" x 1.7" (145 x 43mm)
- WEIGHT: 8.3 oz (235g)

PART NUMBER	COLOR	UPC
20-12578	Gray/Orange	815608025788



BRILA™ USB RECHARGEABLE FAN & LIGHT 2.0 WITH POWER BANK

The 1st Brila USB Rechargeable Fan & Light 2.0 with Power Bank is compact, lightweight and USB rechargeable. Perfect for providing ventilation and light at the campsite, the boat, or on-board emergencies. The stand with integrated hook allows the fan to be hung or propped up anywhere. Featuring a USB rechargeable 3600mAh battery for emergency power bank functionality, so you can charge your mobile devices on the go.

- Compact, convenient portable fan with built-in light
- Battery indicator light flashes red when charging and shines red when fully charged
- Hangs from retractable hook or stands up for area ventilation
- Fan and light work independently
- FAN MODES (left button): LOW>HIGH>OFF
- LIGHT MODES (right button): ON>OFF
- BATTERY: Rechargeable lithium-ion battery (included)
- Input: DC 5V/1.0A
- Output: DC 5V/1.0A
- Capacity: 3600 mAh
- SIZE HxW: 8.6" x 4.7" (218 x 119mm)
- WEIGHT: 16.5 oz (468g)

PART NUMBER	COLOR	UPC
20-12579	Gray/Orange	815608025795



ZINX[®] INTERLOCKING PEGS 6" & 9"

Never lose another tent peg with the Zinx Interlocking Pegs. The unique design allows pegs to be connected for easy storage.

- Easy to set, easy to remove
- Connectible hook feature doubles as a peg puller in a pinch
- Made of high-impact plastic
- Expose to light source for six or more hours of glow
- SIZE (LxWxD): 6" x 1.25" x 1" (153 x 32 x 25mm)
9" x 1.25" x 1" (229 x 32 x 25mm)
- WEIGHT: 6" - 0.7 oz (20g), 9" - 1.1 oz (31g)

PART NUMBER	SIZE	COLOR	PACKAGING	UPC
20-12471	6"	GLO	PDO - 36ct.	815608024712
20-12518	6"	GLO	Hang Sleeve - 6pk.	815608025184
20-12472	9"	GLO	PDO - 36ct.	815608024729
20-12519	9"	GLO	Hang Sleeve - 6pk.	815608025191



GUY LINE REFLECTIVE 4-PK

Reflective lashing with high tenacity, this is the go-to guy line for reliability outdoors.

- Each 13 ft. (4m) coil includes a convenient line-tightener to adjust the rope to the desired length
- Very little stretch when wet
- LENGTH: 156" (396cm) each
- WEIGHT: 3.6 oz (102g) each

PART NUMBER	COLOR	UPC
20-02896-08	Orange/Reflective	811747025238



ALUMINUM STAKES 7" & 9"

Lightweight and heavy-duty tent stakes.

- Rust-resistant
- Designed for hard ground penetration
- SIZE (LxWxD): 7" x 0.25" x 0.5" (178 x 7 x 13mm)
9" x 0.25" x 0.5" (229 x 7 x 13mm)
- WEIGHT: 7" - 0.4 oz (13g), 9" - 0.5 oz (15g)

PART NUMBER	SIZE	UPC
20-12171	7"	815608021711
20-12172	9"	815608021728



EMERGENCY FOOD RATION BARS

The *ust* Emergency Food Ration Bar is a safe, reliable source of nutrition to keep in your survival kit, backpack or shelter-in-place kit.

- 5-year shelf life
- 2,400 calories per bar
- Cholesterol-free
- SIZE LxWxD: 6" x 4.5" x 1.25" (152 x 114 x 32mm)
- WEIGHT: 20.2 oz (573g)

PART NUMBER	COLOR	UPC
1146780	-	661120262671



SURVIVAL BLANKET 2.0

- Ideal for carrying in a day pack for emergencies, or as part of an emergency kit for your car or home
- Windproof and waterproof
- High-visibility, reflective surface for emergency signaling
- Use inside of, or wrapped around, a sleeping bag for extra warmth on cold nights
- 3-ply construction
- SIZE LxW: 60" x 83" (152 x 211cm)
- WEIGHT: 13.6 oz (385g)

PART NUMBER	COLOR	UPC
20-PCB0010-18	Orange/Reflective	811747024224



SAFE & DRY BAGS

- Keeps contents safe from the elements
- D-ring for hanging extra gear or securing the bag
- High-visibility reflective logo
- Buckle features integrated whistle

ITEM	SIZE FLAT HxW	WEIGHT
10 Liter	23.2" x 16.3" (589 x 414mm)	2.0 oz (57g)
15 Liter	27" x 19.7" (686 x 500mm)	2.3 oz (65g)
25 Liter	29.1" x 20.3" (739 x 515mm)	2.5 oz (71g)

PART NUMBER	SIZE	COLOR	UPC
20-12136	10 Liter	lime	815688021368
20-12137	15 Liter	Orange	815688021377
20-12138	25 Liter	Gray	815688021384

 **BOG**

ENGINEERED FOR THE UNKNOWN

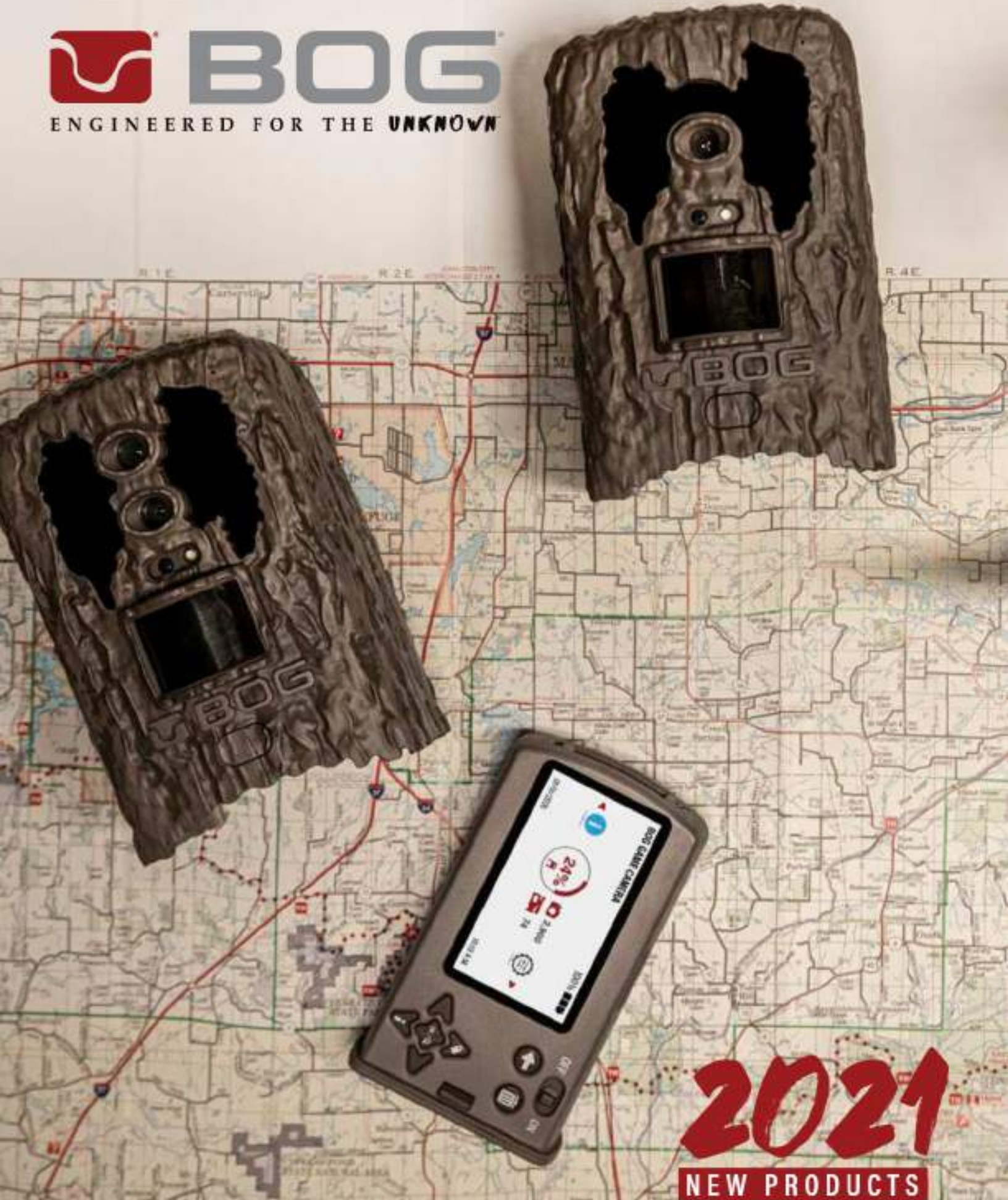

2021
NEW PRODUCTS



WE ALL KNOW AT LEAST ONE...

One who can't stop talking about last years' conquests, or failures; one who tracks cold fronts closer than most meteorologists; one who spends the equivalent of a full time job in the field preparing for that moment. The ones who eat, sleep, and breathe this lifestyle.

They are the *obsessed hunter*...and we're with them.



HAY BALE BLIND

Ground Blind

- 600D Field Khaki fabric w/ PU coating and UV protection
- Full coverage brush loops
- Curtain windows with StealthTrac™ silent window adjustment
- Easy to assemble steel frame
- Trap door that is ideal for finishing waterfowl
- Rebar-style staking system
- Snap-on cover system



Item: 1116634 UPC: 661120080381
Box Size: 19" x 84" x 35" Case Pack: 1



GRAVE DIGGER™

Ground Blind - Realtree® Escape™

- StealthZip™ silent zipper
- StealthTrac™ window retention system
- 360° curtain windows
- 600D polyester fabric w/ UV protection
- 4-Hub design creates more usable room
- 360° brush loops make for easy brushing in
- Standing height design with triangular footprint
- 9" nail stakes- standard

Item: [1147440](#) UPC: 661120107187
Box Size: 10" x 59" x 10" Case Pack: 1



GRAVE DIGGER™

Mossy Oak® Elements Terra™

Item: [1147441](#) UPC: 661120107194 Box Size: 10" x 59" x 10" Case Pack: 1

BUSH WHACKER™

Sitting Ground Blind - Mossy Oak® Elements Terra™

- StealthZip™ silent zipper
- StealthTrac™ window retention system
- 360° curtain windows
- 600D polyester fabric w/ UV protection
- 5-Hub design with square footprint
- 360° brush loops for easy brushing in
- Sitting height design
- 9" nail stakes- standard

Item: [1134435](#) UPC: 661120103752
Box Size: TBD Case Pack: 1



BUSH WHACKER™

Realtree® Escape™

Item: [1134434](#) UPC: 61120103745 Box Size: TBD Case Pack: 1

SNOOD SEAT™

Turkey Chair - Mossy Oak® Obsession®

- Lightweight steel frame construction
- Easy fold-up design
- Comfortable textilene fabric
- Approximate weight capacity: 300 lbs
- Weighs 6.5 lbs

Item: 1134444 UPC: 661120103806
 Box Size: TBD Case Pack: 4



NUCLEUS™

360° Chair

- Lightweight aluminum frame construction
- Extendable leg height
- Heavy-duty textilene fabric construction
- 4-Leg design for ultimate stability
- Approximate weight capacity: 400 lbs
- Weighs 8 lbs

Item: 1115809 UPC: 661120080398
 Box Size: TBD Case Pack: 2



DEATHGRIP® 360

Hunting Rest

- Lightweight aluminum frame construction
- Extendable leg height
- Extendable seat area for maximum comfort
- Comfortable, heavy-duty textilene fabric construction
- 4-Leg design for ultimate stability
- Approximate weight capacity: 400 lbs
- DeathGrip® clamping head with a side-post attachment

Item: 1134447 UPC: 661120103820
 Box Size: TBD Case Pack: 2



CAMO DEATHGRIP®

Precision Tripod

- Prone to standing height adjustment
- Lever-leg locks for secure, easy adjustment
- Dual-adjustment DeathGrip® clamping head with non-marring jaw inserts
- 25 degrees of cant adjustment
- 360° pan with tension adjustment
- Integral bubble level
- Retractable steel foot spikes
- Realtree® Escape™ camo

Item: T134446 UPC: 661120103813
Box Size: 35.4" x 7.5" x 4.7" Case Pack: 2

 PATS: aob.com/patents



DEATHGRIP® ULTRALITE & GREAT DIVIDE® HEAD

Combo

- Magnesium constructed DeathGrip® UltraLite Head
- ARCA-SWISS®, Switcheroo® and 1/4-20, 3/8-16 compatible
- Dual-adjustment DeathGrip® clamping head with non-marring jaw inserts
- Aluminum constructed Great Divide® head
- 360 Degree pan with tension adjustment
- Ultra-smooth tilt functionality
- Ambidextrous handle
- Designed to fit the Adrenaline™ line of pods from BOG®

Item: T137118 UPC: 661120106487
Box Size: TBD Case Pack: 4

 PATS: aob.com/patents



 **BOG**
ENGINEERED FOR THE **UNKNOWN**



RETURNING PRODUCTS

GREAT DIVIDE® TRIPOD HEAD

#1117185 UPC: 661120080503

The Great Divide® Tripod Head turns any standard tripod into a versatile tripod capable of pan, tilt, and quick-exchange Arca-Swiss accessories. The all-weather damping grease makes for ultra-smooth movements, while the micro adjustment technology allows the hunter to finely tune this glassing and shooting platform.

- Durable aluminum construction
- Ultra-smooth head design
- Arca-Swiss compatible
- Weighs less than 1lb
- Ambidextrous handle
- Attaches via 1/4"-20 or 3/8"-16 stud
- Comes with 1 Arca-Swiss plate



DEATHGRIP® ULTRALITE

#1117132 UPC: 661120079057

Patents: aob.com/patents

Our most customer-requested new product for 2020! The DeathGrip® UltraLite mounts to any Arca-Swiss Tripod Head with the included adapter. The Arca-Swiss adapter can be removed exposing 1/4"-20 or 3/8"-16 threaded holes for mounting your own Tripod Head plate or simply threading onto a Tripod Center Post.

- Magnesium construction
- Fits sporter rifles, quad-rail AR platforms and crossbows
- Arca-Swiss compatible
- Switcheroo compatible
- Weighs less than 1lb
- Non-marring rubber jaws
- Patent-pending dual jaw closure design



DEATHGRIP® ELEVATION

#1116643 UPC: 661120079064

Patents: bog.com/patents

Death(Grip) from 20' above! The DeathGrip® Elevation provides secure weapon containment and nearly limitless shooting adjustment, allowing hunters to move quietly and easily for that perfect shot from the treestand.

- Lightweight, rugged construction
- Fits sporter rifles, quad-rail AR platforms and crossbows
- Tri-arm design for maximum shooting range of motion
- Quiet tree strap securement
- Non-marring rubber jaws
- Patent-pending dual jaw closure design
- Secondary clamp strap for additional security



18MP CLANDESTINE™ BLACK FLASH GAME CAMERA

#1116327 UPC: 661120080152

Patents: aob.com/patents

The BOG Clandestine™ camera features lightning fast sub ¼ second trigger speeds, HD video, environmental image stamping, best in class flash range and 3" viewing screen.

- 0.22 second trigger speed/0.6 second recovery
- 18 MP resolution with 1600x900 HD video
- 100 ft flash range/80 ft detection range
- Operates on 6 AA batteries (up to 23k images)
(batteries not included)
- Removable Menu with 3" Color TFT Viewing Screen
- Multi-Shot (1-8 images)/Rapid Fire (1-8 images)
- SD Card Compatible (up to 512GB)
- Temp/Date/Time/Baro Pressure/Moon Phase Stamps



22MP BLOOD MOON™ INFRARED GAME CAMERA

#1116328 UPC: 661120080169

Patents: aob.com/patents

The BOG Blood Moon™ Infrared camera features lightning fast sub ¼ second trigger speeds, HD video, best in class flash range and 3" viewing screen and dual sensor technology.

- 0.22 second trigger speed/0.6 second recovery
- 22 MP resolution with FHD (1080) video
- 120 ft flash range/80 ft detection range
- Operates on 6 AA batteries (up to 23k images)
(batteries not included)
- Removable Menu with 3" Color TFT Viewing Screen
- Multi-Shot (1-8 images)/Rapid Fire (1-8 images)
- SD Card Compatible (up to 512GB)
- Temp/Date/Time/Baro Pressure/Moon Phase Stamps
- Dual Sensor for High Quality Day and Night images



BOG CAMERA CARD READER

#1131488

- Ability to read SD and Micro SD cards
- Compatible with iPhone, Android, Windows, and Apple
- Comes with micro USB, USB-C and Lightning adapter
- Plug and play operation. No app needed.

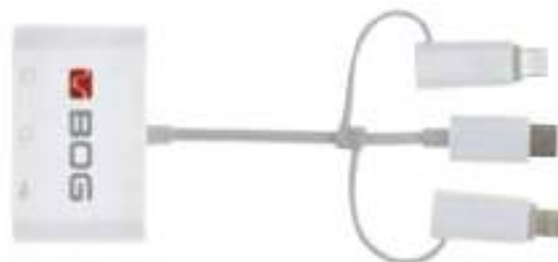

DOMINION™ CAMERA MENU/VIEWER

#1116334 UPC: 661120080497

Patents and copyrights

The BOG camera menu and image viewer works universally as a spare or secondary viewer for the 18 MP black flash and 22 MP dual sensor infrared cameras. This item allows users to quickly change menu settings or swap SD cards and batteries while checking cameras, requiring minimal time at the camera site, but simply ejecting one viewer and replacing it with the new viewer.

- 3" Color TFT Screen
- Operates on 6 AA batteries or optional BOG rechargeable battery pack *(batteries not included)*
- Intuitive menu with easy to read icons
- SD Card and micro USB compatible
- Replaceable unit for BOG Black Flash and High-End Infrared Game Cameras



OMNIPOTENCE™ RECHARGEABLE CAMERA BATTERY PACK

#1116329 UPC: 661120080480

- Rechargeable Li-ion battery pack
- Charge lasts approx. 11 months under normal camera use (35 day photos, 35 night photos)
- Designed for drop-in use with BOG Clandestine and Blood Moon game cameras
- USB charging port
- LED charge status indicator



FIELD GENERAL™ STEP-IN GAME CAMERA MOUNT

#1112787 UPC: 661120080459

With the release of the BOG camera lineup, BOG is introducing a full assortment of game camera accessories. The Step-In Game Camera Mount is the perfect mount for open field coverage. Simply step the tapered legs into the ground, secure the camera on the mini ball head and get shots of deer that would normally go undetected.

- Durable steel frame construction
- Tri-leg design for maximum stability
- Ball head design for easy and secure camera placement
- Total height: 25.5" Collapsed
53" Extended



FARM HAND® T-POST GAME CAMERA MOUNT

#1112785 UPC: 661120080442



With the release of the BOG camera lineup, BOG is introducing a full assortment of game camera accessories. The T-Post Game Camera Mount is perfect for large food plots and areas without good camera hanging trees. The mini ball head allows hunters to customize their angle, to get just the right shot. Simply drive the post in, secure the mount to the post, adjust the ball head and let the camera do the rest.

- Durable aluminum construction
- Adjustable knob tension for universal post securement
- Ball head design for easy and secure camera placement

CONSTRUCTOR® GAME CAMERA MOUNT

#1112786 UPC: 661120080435



With the release of the BOG camera lineup, BOG is introducing a full assortment of game camera accessories. The Constructor® Game Camera Mount gives hunters the ability to mount their cameras without damaging trees. The mini ball head allows the camera to be positioned at nearly any angle to capture that perfect image.

- Durable aluminum construction
- Ratchet strap securement design
- Strap length: 78"
- Max tree diameter: 2"
- Ball head design for easy and secure camera placement

TUNNEL VISION® SCREW-IN GAME CAMERA MOUNT

#1112784 UPC: 661120080428



With the release of the BOG camera lineup, BOG is introducing a full assortment of game camera accessories. The Tunnel Vision® Screw-In Game Camera Mount features an aggressive-bite tree auger, making it easy to mount any game camera.

- Durable aluminum construction
- Aggressive-bite tree auger
- Ball head design for easy and secure camera placement



TRIPLE PLAY™ GROUND BLIND CHAIR

#1117130 UPC: 661120080411

The BOG Triple Play™ Chair was designed to be the ultimate carry-in hunting chair. Constructed with a lightweight, yet durable aluminum frame, this chair weighs in at just 4.5 lbs, while supporting up to 300 lbs. The ultra-comfortable Textilene® fabric, combined with a generously sized seat that eliminates pinch points, allows hunters to comfortably sit all day, waiting for that buck of a lifetime to walk by.

- Lightweight aluminum frame construction
- Heavy-duty Textilene fabric construction
- Extended seat area for maximum comfort
- Sewn-in accessory pouch
- Carry strap
- Weight: 4.5 lbs
- Approximate weight capacity: 300 lbs



4 ON THE FLOOR® GROUND BLIND CHAIR

#1117129 UPC: 661120080404

The BOG 4 on the Floor® Chair is the epitome of all-day comfort, wrapped up in a lightweight package. Constructed with a lightweight, yet durable aluminum frame, this chair weighs in at just 5.5 lbs, while supporting up to 400 lbs. The ultra-comfortable Textilene fabric, combined with a generously sized seat and extended height make this the perfect chair for any blind application.

- Lightweight aluminum frame construction
- Heavy-duty Textilene and nylon fabric construction
- Extended seat height for use in all blinds
- Extended seat area for maximum comfort
- Weight: 5.5 lbs
- Approximate weight capacity: 400 lbs



GREAT DIVIDE® TRIPOD #1100483

Box Size: 4.7"W x 21.7"H x 4.7"D Case Pack: 4

- Engineered to be the perfect western hunting tripod
- Constructed of lightweight, high-strength carbon fiber legs
- Fluid head compatible with all Arca-Swiss attachments
- 3-position leg locks for prone, sitting, kneeling and standing positions
- Adjusts from prone to standing shooting heights
- Weight: Approx. 4lbs



Reinvented USB design allows for easy passage of swivel stud



Arca-Swiss attachment compatible



Multiple lever locks provide stable leg security at all heights



Adjust tilt and pan up to 60°

DEATHGRIP™ ALUMINUM TRIPOD #1099442

Box Size: 7.5"W x 34.5"H x 7.5"D Case Pack: 2

- Engineered to be the most stable shooting platform for its price point
- Durable, aluminum construction
- Secures any weapon for hands-free use
- Integral bubble level
- Retractable steel spikes secure into virtually any terrain
- 3-position leg lock for prone, kneeling, sitting and standing positions
- Weight: Approx. 8.5lbs

"Patents: aob.com/patents"



No-slip lever locks

Adjustment knob controls up to 50° of tilt

Clamping head pans 360° with tension adjustment

Large diameter aluminum legs

DEATHGRIP™ CARBON FIBER TRIPOD #1099443

Box Size: 7.5"W x 34.5"H x 7.5"D Case Pack: 2

- Engineered to be the most stable shooting platform on the market
- Carbon fiber legs are **20% lighter** and **6x stronger** than aluminum legs
- Secures any weapon for hands-free use
- Integral bubble level
- Retractable steel spikes secure into virtually any terrain
- 3-position leg lock for prone, kneeling, sitting and standing positions
- Weight: Approx. 7.5lbs

"Patents: aob.com/patents"



No-slip lever locks

Adjustment knob controls up to 50° of tilt

Clamping head pans 360° with tension adjustment

Large diameter carbon fiber legs

HAVOC™ SERIES

HAVOC™ TRIPOD #1100479

HAVOC™ TRIPOD CAMO #1100485

Hanging Size: 5.9"W x 23"H x 2"D Case Pack: 4

- Highly portable shooting platform
- Durable, aluminum construction
- Quick, twist lock leg deployment
- Adjusts from sitting to kneeling shooting positions



HAVOC™ BIPOD #1100478

HAVOC™ BIPOD CAMO #1100484

Hanging Size: 5.9"W x 25"H x 1.3"D Case Pack: 4

- Highly portable shooting platform
- Durable, aluminum construction
- Quick, twist lock leg deployment
- Adjusts from sitting to kneeling shooting positions.



HAVOC™ MONOPOD #1100477

Hanging Size: 5.9"W x 27"H x 1.3"D Case Pack: 4

- Highly portable shooting platform
- Durable, aluminum construction
- Quick, twist lock leg deployment
- Adjusts from sitting to kneeling shooting positions.



ADRENALINE™ SERIES

ADRENALINE™ TRIPOD #1100482

ADRENALINE™ TRIPOD CAMO #1100488

Box Size: 4.7"W x 25.6"H x 4.7"D Case Pack: 4

- Engineered for portability and versatility
- Durable, aluminum construction
- Patented USR shooting yoke
- Patented SWITCHEROO® mounting system
- Retractable steel spikes secure into virtually any terrain
- Adjusts from sitting to standing shooting positions

switcheroo
SHOOTING SYSTEM



Patented USR provides ultimate stock stability

Head rotates 360°

High density foam grips

No-slip lever locks provide secure locking, quiet release



ADRENALINE™ BIPOD #1100481

ADRENALINE™ MONOPOD CAMO #1100487

Box Size: 4.7"W x 27.6"H x 3.1"D Case Pack: 4

- Engineered for portability and versatility
- Durable, aluminum construction
- Patented USR shooting yoke
- Patented SWITCHEROO® mounting system
- Retractable steel spikes secure into virtually any terrain
- Adjusts from sitting to standing shooting positions

switcheroo
SHOOTING SYSTEM



No-slip lever locks provide faster locking and release



ADRENALINE™ MONOPOD #1100480

ADRENALINE™ MONOPOD CAMO #1100489

Box Size: 4.7"W x 27.6"H x 3.1"D Case Pack: 4

- Great for shooting and hiking!
- Durable, aluminum construction
- Patented USR shooting yoke
- Patented SWITCHEROO® mounting system
- Retractable steel spikes secure into virtually any terrain
- Adjusts from sitting to standing shooting positions

switcheroo
SHOOTING SYSTEM



FIELDPOD® #1100471

Box Size: 24.6"W x 7.3"H x 5.9"D Case Pack: 4

- Supports shotguns, rifles and crossbows
- Portable, collapses quickly for transportation
- Overmolded, non-marring front and rear supports
- Lightweight, durable aluminum construction
- Adjusts from sitting to kneeling shooting positions



FIELDPOD® MAX #1100473

Box Size: 28.25"W x 7.3"H x 67.3"D Case Pack: 4

- Supports shotguns, rifles and crossbows
- Independent leg adjustment
- Integral bubble level for upper frame
- Ultra-stable, dual-frame aluminum construction
- Adjusts from sitting to kneeling shooting positions
- Cast aluminum hub allows for secure, smooth 360° rotation



FIELDPOD® MAGNUM #1100474

Box Size: 39"W x 7.7"H x 7"D Case Pack: 2

- Supports shotguns, rifles and crossbows
- Independent leg adjustment
- Integral bubble level for upper frame
- Ultra-stable, dual-frame aluminum construction
- Adjusts from sitting to standing shooting positions
- Cast aluminum hub allows for secure, smooth 360° rotation



CHAIRPOD™ #1100475

Box Size: 24"W x 19.75"H x 8"D Case Pack: 2

- Supports shotguns, rifles and crossbows
- Swing-arm system and 360° silent swivel chair allows for maximum range of movement
- Overmolded, non-marring front and rear supports
- Great for hunting from ground blinds, field edges or shooting at the range
- Durable steel-frame construction supports up to 300lbs.
- Up to 41" vertical adjustment
- Integrated shoulder carry strap included



TREEPOD™ #1100476

Box Size: 23.5"W x 12"H x 6.75"D Case Pack: 2

- Fully supports shotguns, rifles and crossbows
- Anodized aluminum and powder coated steel construction
- Overmolded, non-marring rear and front rests
- Safety gun retention strap included
- Upper frame and swing-arm easily detach for compact transport
- Universal attachment base included



KEY FEATURES:

UNIVERSAL SHOOTING REST #735538

Clam Size: 9.5"W x 6"H x 1.25"D Case Pack: 4



switcheroo
SHOOTING SYSTEM

- New design allows for easy passage of swivel stud
- Attaches to any Switcheroo® BOG® shooting stick
- Provides 360° head rotation
- Weight approx. 4oz

WIDE BODY UNIVERSAL SHOOTING REST #735555

Clam Size: 8.6"W x 5.75"H x 4"D Case Pack: 4

Patents: acb.com/patents



switcheroo
SHOOTING SYSTEM

The Wide Body Universal Shooting Rest is both deeper and wider than the Universal Shooting Rest and is designed to give the added stability needed to take that longer shot.

- Approx. 2.75" wide x 4" deep
- Attaches to any Switcheroo® BOG® shooting stick
- Provides 360° head rotation
- Weight approx. 7.9

XTREME REST #735539

Clam Size: 19.6"W x 8"H x 2.9"D Case Pack: 4

Patents: acb.com/patents



- Uses (2) Universal Shooting Rests with lateral adjustment to fit most firearms
- (2) hook & loop straps to secure firearm into place
- Lightweight aluminum (approx. 18oz)
- Balances firearm over tripod
- Approx. 15.5"L x 2"W

QUICK-RELEASE PLATE #735537

Clam Size: 8.8"W x 5"H x 1"D Case Pack: 8



KEY FEATURES:

- Plate is 1 5/8" x 2" in size and comes with standard 1/4"-20 camera screw and a 3/8"-16 adapter screw
- Makes other BOG® accessories Camera Adapter and Scope Adapter compatible
- Plates are sold in a (2) pack

PROFESSIONAL CAMERA ADAPTER #735546

Clam Size: 11.2"W x 3.4"H x 7.2"D Case Pack: 4

Patents: acb.com/patents



switcheroo
SHOOTING SYSTEM

- Pistol-grip style ball head allows for one-handed operation
- Omni-directional ball for multi-direction rotation and tilt
- Accessory plate has 1/4"-20 and 3/8"-16 thread bushings
- Integral bubble level
- Side lever to lock rotation
- Weight approx. 21oz

BINOCULAR REST #735547

Clam Size: 8.6"W x 7.4"H x 2.4"D Case Pack: 4

Patents: acb.com/patents



switcheroo
SHOOTING SYSTEM

- High-strength, lightweight ABS plastic
- Non-slip rubber-covered platform
- Includes a 3/8"-16 thread and 1/4"-20 size bushing
- 3 1/4" deep x 6" wide x 3/4" tall
- Weight approx. 7oz

STANDARD CAMERA ADAPTER #735549

Clam Size: 9.7"W x 6.2"H x 3.3"D Case Pack: 4



switcheroo
SHOOTING SYSTEM

- Omni-directional ball for multi-direction rotation and tilt
- Top lever release lock to prevent accidental lever release
- Accessory plate has 1/4"-20 and 3/8"-16 thread bushings to fit most mounts
- Integral bubble level
- Weight approx. 14oz

SPOTTING SCOPE ADAPTER #735561

Clam Size: 11"W x 9.6"H x 2.4"D Case Pack: 4



switcheroo
SHOOTING SYSTEM

- Base is compatible with the Universal Shooting Rest
- Head detaches to fit on any BOG® shooting pod
- Accessory plate is 1 5/8" x 2" in size and fits most common camera mounts
- Integral bubble level
- Adjustable tilt and 360° rotation
- 3/16"-24" and 1/4"-20" thread bushings

ADAPT-A-POD #735554

Clam Size: 4.5"W x 4.3"H x 0.5"D Case Pack: 4



KEY FEATURES:

switcheroo
SHOOTING SYSTEM

The ADAPT-A-POD allows use on BOG® accessories with any standard monopod, bipod or tripod on the market.

RAPID SHOOTING REST #110113

Clam Size: 17.9"W x 3.3"H x 3.1"D Case Pack: 4

Patents: www.boghunt.com/patents



switcheroo
SHOOTING SYSTEM

- Twist-lock height elevation 7"–11"
- Diecast aluminum construction
- Collapses for transport
- Non-marring, non-slip feet
- Weight approx. 21.6oz

SLING SWIVEL MOUNT #735562

Clam Size: 8.5"W x 4.5"H x 1"D Case Pack: 4



switcheroo
SHOOTING SYSTEM

This mounts directly to the rifle sling swivel stud. One end can be mounted to any SWITCHEROO® compatible BOG®. The other end is a sling swivel stud, allowing mounting to a sling while the sling swivel mount is attached.

SHOOTING STICKS (STANDING) #735565

Clam Size: 18.8"W x 5"H x 3"D Case Pack: 4



- 72" usable height
- Durable 9/16" diameter aluminum tubing
- Elastic strap keeps collapsed sticks bound and quiet for transport
- Weight approx. 16oz

SHOOTING STICKS (SITTING) #735560

Clam Size: 19.8"W x 4"H x 2.3"D Case Pack: 4



- 39" usable height
- Durable 9/16" diameter aluminum tubing
- Elastic strap keeps collapsed sticks bound and quiet for transport
- Weight approx. 11oz

 Hooyman™



YOUR LAND. YOUR LEGACY.™

What started in Appleton, Wisconsin as a father and son's passion for Whitetail hunting is now one of the leading names in land management. After the first portable tree saw came to market in 2008, Hooyman® continued to innovate with ground-breaking land management tools upholding the same values the brand was founded on; quality, innovation, and service valuing every customer relationship.

Regardless of acreage, Hooyman® is tying together land managers across the country through mutual respect and admiration for the land and the animals that thrive off it. We are a brand made for the conservationist by the conservationist—preserving the experience for future generations.

Hooyman® is no longer just a name; it's a lifestyle.



conserve

A way to benefit the land

UNIVERSAL LITHIUM-ION 35LB HAND SPREADER #1149081

Hooymann® is breaking into land management with the most innovative hand spreader on the market. The universal 24 volt (accepts 18-24 volts) spreader is the biggest chest spreader in the family and stands alone at the top of the market as the most versatile model as it accepts most major brands of lithium-ion batteries. Made for large plots and all day use. The easy-fill hopper lays on its back to prevent seed loss while filling. The precise seed rate adjustment can adjust from clover and turnip seed to soybeans and corn. The front carry harness detaches from the hopper for easy-fill and easy lifting to alleviate back and shoulder pain.

- Compatible with most 18-24 volt Li-ion handheld tool batteries, comes with 8 different adapters
- Feed rate and activation is in one movement, unlike all other spreaders where they are separate
- High efficiency motor. Patent pending throwing disc design that launches seed 10-25 ft.
- Single motion activation and feed rate control
- Easy-fill with translucent hopper
- Larger hopper for less time spent filling
- Secure and easy seed rate adjustment
- Durable lightweight motor with variable disc speed control
- Comfortable front harness carry system that detaches from the hopper for easy filling
- UPC: 661120107637

Patents: ask.com/patents



24V LITHIUM-ION 35LB HAND SPREADER #1141041

Hooymann® is breaking into land management with the most innovative hand spreader on the market. Made for large plots and all day use. The easy-fill hopper lays on its back to prevent seed loss while filling. The precise seed rate adjustment can adjust from clover and turnip seed to soybeans and corn. The front carry harness detaches from the hopper for easy-fill and easy lifting to alleviate back and shoulder pain.

- 24 volt rechargeable power for extended use and larger throw radiuses with larger seed
- Feed rate and activation is in one movement, unlike all other spreaders where they are separate
- High efficiency motor. Patent pending throwing disc design that launches seed 10-25 ft.
- Single motion activation and feed rate control
- Easy-fill with translucent hopper
- Larger hopper for less time spent filling
- Secure and easy seed rate adjustment
- Durable lightweight motor with variable disc speed control
- Comfortable front harness carry system that detaches from the hopper for easy filling
- UPC: 661120107620

Patents: ask.com/patents



MANUAL BROADCAST 35LB SPREADER #1135909

Hooyman® is breaking into land management with the top of the line manual broadcast spreader. Keeping all of the innovative designs without the battery power allows this affordable spreader to compete with the simple bag feeders on the market. The easy-fill hopper lays on its back to prevent seed loss while filling. The precise seed rate adjustment can adjust from clover and turnip seed to soybeans and corn. The front carry harness detaches from the hopper for easy-fill and easy lifting to alleviate back and shoulder pain.

- Non slip grip crank handle
- Easy-fill hopper
- Secure and easy seed rate adjustment
- Durable and lightweight hopper design
- Comfortable front harness carry system that detaches from the hopper for easy filling
- UPC: 661120107644

Patents: acb.com/patents



24V BATTERY #1149083



- Battery life indicator
- Easy disconnect buttons
- 90 minute continuous runtime
- UPC: 661120260530

24V BATTERY CHARGER #1149530



- 6ft cord length
- Charge light indicator
- Output: 24V DC, 3.0 A
- Input: 120V, 60Hz, 85W
- UPC: 661120260547

125LB ATV SPREADER #1135914

Hooyman® is breaking into land management with the top of the line ATV/UTV seeder. The wide mouth easy-fill hopper prevents seed loss. The precise seed rate adjustment can adjust from clover and turnip seed to soybeans and corn. The smart connection system comes with SAE, 12V cigarette adapters, and, alligator battery clamps and quick disconnects that allow for easy removal of the spreader without requiring access to the battery or requiring any tools. U-bolt smart connect rack allows for easy attachment to any ATV rack. Conveniently placed handles allow for this unit to be transportable unlike other models.

- Universal mounting system for ATV
- Quick detach design for easy storage when finished
- Wide mouth easy-fill hopper
- Clear window for seed level viewing
- Durable and easy seed rate adjustment
- Smart battery connection system
- Durable lightweight hopper with easy transport handles
- First of its kind, handle bar mounted feed rate and throw distance control (no more turning around to start or stop the spreader)
- UPC: 661120107651



grip

A better way to work

H-GRIP™ TAPE #1135912

Hooymann® H-Grip™ tape improves the performance of any tools in your arsenal. The proprietary technology enhances your grip when wet. This tape performs under the hottest and dirtiest conditions getting the most out of your tool with a comfortable secure grasp. Focus less on the grip and focus more on the task at hand. Easy application only takes minutes and will stay in place for years to come.

- H-Grip™ technology gets stickier when wet
- 2.3mm thick
- Reinforced adhesive backing design for long term use
- Easily applies in minutes
- Conforms to any shape or handle to enhance the performance of your tool
- UPC: 661120104797



LIGHTWEIGHT H-GRIP™ GLOVES

Hooymann® H-Grip™ gloves are designed to help your grip and performance on any job. The No-Slip H-Grip™ proprietary technology gives you the best available grasp on the market.

- Form fitting neoprene cuff
- Lightweight breathable mesh
- No-Slip H-Grip™ on palm
- Pre-curved fingers for added comfort
- TPR molded strap for adjustable comfort
- Synthetic finger side walls for added breathability
- **Small** - 1151257 - UPC: 661120262442
- **Medium** - 1151258 - UPC: 661120262459
- **Large** - 1151259 - UPC: 661120262466
- **X-Large** - 1151260 - UPC: 661120262473



MIDWEIGHT H-GRIP™ GLOVES

Hooyman® H-Grip™ gloves are designed to help your grip and performance on any job. The No-Slip H-Grip™ proprietary technology gives you the best available grasp on the market. The padded knuckle guards and thumb guard prevent impact injuries and protect your hands while working. Built to withstand abusive and heavy workload these gloves are designed to work hard.

- Added fingertip durability
- Form fitting neoprene cuff
- Lightweight breathable mesh
- Padded knuckles for protection
- No-Slip H-Grip™ on palm
- Pre-curved fingers for added comfort
- TPR molded strap for adjustable comfort
- Synthetic finger side walls for added breathability
- **Small** - 1148049 - UPC: 661120260554
- **Medium** - 1148050 - UPC: 661120260561
- **Large** - 1136928 - UPC: 661120107668
- **X-Large** - 1148051 - UPC: 661120260578



protect

Secure your hard work

H-GRIP™ POST DRIVER #1135911

Hooyman® H-Grip™ fence post driver is the first in its class to add comfort and grip to a traditional steel post driver. No more skinny metal bars to grab onto. This post driver features the proprietary No-Slip H-Grip™ technology on the handles giving you a comfortable and secure grip allowing the post driver to be more effective with every hit. The angled handles keep the driver closer to your body allowing more power through every hit.

Patents: add-compatents

H-GRIP™ FIBERGLASS POST DRIVER #1139426

Hooyman® H-Grip™ Fiberglass post driver is the first of its kind. No more splintered poles or missed swings with hammers. Set up your electric fencing quicker than ever before with the first fiberglass fence post driver. The easy remove feature lets you leverage poles that are already in the ground and remove them with ease.

Patents: add-compatents

RENDER



- No-Slip H-Grip™ handle
- Angle designed for maximum performance
- Lifetime warranty
- Patent pending
- UPC: 661120107675

- No-Slip H-Grip™ handle
- Patent pending design for easy post removal
- Lifetime warranty
- UPC: 661120107682



returning products

land management tools

strike

a new line of cutting tools

CHOPPING AXE



28"

SPLITTING AXE



28"

LARGE HATCHET



19"

SMALL HATCHET



15"

#1112241 Small Hatchet UPC: 661120080046
#1112240 Large Hatchet UPC: 661120080039
#1112238 Splitting Axe UPC: 661120079583
#1112239 Chopping Axe UPC: 661120079613

- V-grind
- 52 Rockwell hardness
- 1065 High carbon steel
- Modern aesthetic design
- Peg hole for easy storage
- Ergonomic, no-slip H-GRITM handle
- Protective sheath included for easy storage
- Reinforced, fiberglass neck (strongest neck on market)

SPLITTING MAUL



- Convex grind
- Head weight: 8lbs
- Modern aesthetic design
- 1045 High strength steel
- 45-60 Rockwell hardness
- Peg hole for easy storage
- Ergonomic, no-slip H-GRIP™ handle
- Reinforced, fiberglass core handle

PICK MATTOCK



- Modern aesthetic design
- 1045 High strength steel
- 45-60 Rockwell hardness
- Peg hole for easy storage
- Reinforced, fiberglass core handle
- Ergonomic, no-slip H-GRIP™ handle
- 2 head profiles:
Pick is used for breaking and prying Adze is used for digging and cutting into the ground

SPLITTING WEDGE



- Weight: 5 pounds
- Overall length: 8.75 in
- Wedge width: 2.1 in
- 1045 High Strength Steel

#1112248 Splitting Maul UPC: 661120079620
 #1112249 Pick Mattock UPC: 661120080022
 #1112261 Splitting Wedge UPC: 661120079699

KUKRI MACHETE



20.25"

BUSH MACHETE



20.25"

HOOK EM' MACHETE



17"

- 3Cr 13 Stainless Steel
- Modern aesthetic design
- Custom sheath with belt loops
- Handle peg hole for easy storage
- Ergonomic, no-slip H-GRIP™ handle

- #1112236 Kukri Machete UPC: 661120079071
- #1112234 Bush Machete UPC: 661120079590
- #1112237 Hook em' Machete UPC: 661120079606

impact

A new found strength

**16lb SLEDGE
HAMMER**



36"

**10lb SLEDGE
HAMMER**



36"

**8lb SLEDGE
HAMMER**



35"

**4lb CLUB
HAMMER**



11"

**2.5lb CLUB
HAMMER**



10"

- 1045 High Strength Steel
- Modern aesthetic design
- 45-60 Rockwell Hardness
- Peg hole for easy storage
- Reinforced, fiberglass core handle
- Ergonomic, no-slip H-GRIP™ handle

- #1112260 16lb Sledge Hammer UPC: 661120079682
- #1112259 10lb Sledge Hammer UPC: 661120079675
- #1112255 8lb Sledge Hammer UPC: 661120080053
- #1112254 4lb Club Hammer UPC: 661120079668
- #1112253 2.5lb Club Hammer UPC: 661120079651

trim

A clear line of sight

14' POLE SAW



- Custom Sheath
- SK5 Steel Blade - 13"
- Overmolded comfort grip
- 14ft lock-in extension pole
- Ergonomic, non-slip grip handle

CURVED BLADE SAW



- Custom Sheath
- Overall length: 19.75"
- Overmolded comfort grip
- Ergonomic, no-slip H-GRIP™ handle
- SK5 MegaBite™ Curved Steel Blade - 13"

BOW SAW



- SK5 Steel Blade - 24"
- Overmolded comfort grip
- Ergonomic, no-slip H-GRIP™ handle

#1117119 14' Pole Saw UPC: 661120079767

#1112250 Curved Blade Saw UPC: 661120079637

#1112251 Bow Saw UPC: 661120079644

FORGED LOPPERS



27.5"

- Forged blades
- Overall length: 27.5"
- Modern aesthetic design
- Ergonomic, no-slip H-GRIP™ handles
- Forged connectors, strongest on market

RATCHET PRUNERS



8"

- 5x Cutting power
- 1" Cutting capacity
- SK5 High carbon steel blade
- No-Slip H-GRIP™ handle design
- Thumb-locking latch keeps blades secure
- Teflon coated blades to prevent corrosion and rust

BYPASS PRUNERS



7.5"

- .7" Cutting capacity
- SK5 High carbon steel blade
- No-Slip H-GRIP™ handle design
- Ergonomic positive locking-latch
- Teflon coated blades to prevent corrosion and rust

#1116632 Forged Loppers UPC: 661120079750

#1099080 Ratchet Pruners UPC: 661120416715

#1099084 Bypass Pruners UPC: 6611201416722

excavate

Ground work made easy

DIGGING SHOVEL



TRANSFER SHOVEL



SPADE SHOVEL



- 1050 Carbon Steel
- Modern aesthetic design
- Reinforced, fiberglass core handle
- Ergonomic, no-slip H-GRIP™ handle

- #1116234 Digging Shovel UPC: 661120079705
- #1116629 Transfer Shovel UPC: 661120079743
- #1116244 Spade Shovel UPC: 661120079712

BOW RAKE



- High Carbon Steel
- Modern aesthetic design
- Forged head construction
- Ergonomic, no-slip H-GRIP™ handle

LANDSCAPE RAKE



- Fiberglass handle
- Modern aesthetic design
- Extruded, lightweight anodized aluminum head
- Ergonomic, no-slip H-GRIP™ handle

#1116246 Bow Rake UPC: 661120079729

#1116247 Landscape Rake UPC: 661120079736

protect

Secure your hard work

HOT ZONE™ FOOD PLOT FENCE #1099105 UPC: 661120418337

The Hooyman® Hot Zone™ Food Plot Fence is a complete fence kit that allows you to manage your browse pressure on your food plots, ensuring maximum plot success. Heavy browse pressure can cause poor plot production or even failure. Protect your investment of time, money and labor with the Hot Zone™ Fence keeping deer out of your food plot until your ready to let them in. The system can easily be deactivated to allow deer to feed.

- 1 - Ground rod
- 1.0 Joule energizer
- 10 Watt solar panel
- 4 - Wire tensioners
- 45 - Rod insulators
- 16 - Corner insulators
- 8 - 1/2" fiberglass poles
- 24 - 3/8" fiberglass poles
- 656 ft polytape electric wire
- 1,312 ft polyrope (non-electric)
- Covers up to 1/2 acre



HOT ZONE™ GARDEN FENCE #1099106 UPC: 661120418344

The Hooyman® Hot Zone™ Garden Kit is a complete fencing kit that allows you to protect your garden from raccoons, rabbits, deer and other pests that can destroy your garden. Protect your investment of time, money and hard work in your garden to ensure a successful yield. The system can be deactivated to enter the garden at any time.

- 1 - Ground rod
- 0.5 Joule energizer
- 10 Watt solar panel
- 4 - Wire tensioners
- 24 - Rod insulators
- 16 - Corner insulators
- 4 - 1/2" fiberglass poles
- 12 - 3/8" fiberglass poles
- 656 ft polytape electric wire
- 666 ft polyrope (non-electric)
- Covers up to 1/4 acre



HOT ZONE™ POLYROPE

#1119599 UPC: 661120079774



- 656 ft. Length
- 3/32 in. Diameter

HOT ZONE™ POLYTAPE

#11196009 UPC: 661120079781



- 656 ft. Length
- Industry leading conductivity
- 1/2 in. Polytape
- Resistance 0.25 Ohms/meter

HOT ZONE™ 3/8" FIBERGLASS POLES

(Single)

#11131239 UPC: 661120079811

(10-pack)

#11196039 UPC: 661120079804



- 3/8 in. Thick
- 47 in. Long

HOT ZONE™ 1/2" FIBERGLASS POLES

#1119602 UPC: 661120079798



- 1/2 in. Thick
- 47 in. Long
- 4-pack

HOT ZONE™ WIRE TENSIONER

#11196059 UPC: 661120080077



- 4-pack

HOT ZONE™ POST INSULATOR

#11196019 UPC: 661120080060



- 25-pack
- Fits up to 1/2 in. post

CORDLESS 40V LITHIUM POLE SAW #655236

Box Size: 11.25"W x 44.5"H x 5.25"D Case Pack: 1



KEY FEATURES:

- Extended length of 10ft
- 3-piece detachable section collapses to 48" for easy transport or storage
- Up to 70 minutes of runtime
- Weighs approx. 9.7lbs
- Auto-oiler with clear view window
- Battery charge-level indicator

INCLUDES

- 40V Lithium-Ion battery
- Battery Charger (charge time approx. 60min)
- Carry case

40V POLE SAW ACCESSORIES:

REPLACEMENT CHAIN BAR #655238

Clam Size: 14"W x 4.4"H x 0.25"D Case Pack: 4

SPARE 40V LITHIUM-ION BATTERY #655237

Clam Size: 7"W x 3.5"H x 3.4"D Case Pack: 4

REPLACEMENT CHAIN #655239

Clam Size: 5.6"W x 3.7"H x 0.7"D Case Pack: 4

3"8" POLE EXTENSION #110051

Clam Size: 40.5"W x 2.4"H x 2.4"D Case Pack: 4



5-FOOT EXTENDABLE TREE SAW #655226

Box Size: 5"W x 13.6"H x 3"D Case Pack: 6

Patents: ask.com/patents



KEY FEATURES:

- Lockback blades
- Collapses to 12"
- I-beam aluminum construction
- 7" High carbon SK-5 steel blade
- MegaBite™ XP 4-edge tooth design
- Secure extended saw or detach for hand saw use

10-FOOT EXTENDABLE TREE SAW #655227

Box Size: 5"W x 26.7"H x 3"D Case Pack: 6

Patents: ask.com/patents



- Lockback blades
- Collapses to 28"
- 7" High carbon SK-5 steel blade
- MegaBite™ XP 4-edge tooth design
- Secure extended saw or detach for hand saw use
- I-beam aluminum construction

5-FOOT/10-FOOT REPLACEMENT BLADE #655230

Clam Size: 7.5"W x 2"H x 0.2"D Case Pack: 25



- 7" High carbon SK-5 steel blade
- MegaBite™ XP 4-edge tooth design

5-FOOT CASE #655228

Clam Size: 14.2"W x 4.6"H x 3.3"D Case Pack: 20

- Imported, black nylon case
- Reinforced polymer straps



8" MEGABITE™ COMPACT HANDSAW #110050

Clam Size: 15.6"W x 7.9"H x 1.3"D Case Pack: 6



KEY FEATURES:

- 17" extended (folds to 9.5")
- 2-position lockback blade
- MegaBite™ XP 4-edge tooth design
- High carbon SK-5 steel blade
- Ergonomic rubber overmolded handle

6" MEGABITE™ COMPACT HANDSAW #110049

Clam Size: 15.3"W x 7.8"H x 0.8"D Case Pack: 6



- 12" extended (folds to 6.5")
- 2-position lockback blade
- MegaBite™ XP 4-edge tooth design
- Highcarbon SK-5 steel blade
- Ergonomic rubber overmolded handle

MEGABITE™ HUNTER'S COMBO #110143

Clam Size: 4.1"W x 13"H x 3.3"D Case Pack: 6



INCLUDES

- 8" MegaBite™ Blade XP 4-edge tooth design (#110050)
- 8" MegaBite™ Bone Blade XP 4-edge tooth design
- Ergonomic rubber overmolded handle
- Nylon carry case





Built for generations.™

BUILT FOR WORKING HANDS

Founded in 1958, Old Timer created a knife built with durability in mind but also a tool that was comfortable enough to work with day after day. For over 60 years now, Old Timer has created knives for the working class. Knives built for those who don't rely on others to get the job done. We didn't just stop there; as the years went on we have created knives for the outdoorsman.

Old Timer is more than just a knife - it's a timeless tool meant to be passed down. When you craft a knife designed to last generations it becomes more than just a tool. It becomes memories made, lessons learned, and values taught.

Passing on a knife is more than a gift.





GENERATIONAL SERIES



GENERATIONAL USA 1520TG SHARPFINGER® - 1135991

- USA Made
- 3.5" Blade
- 1095 HC Steel
- Leather Sheath
- UPC: 641120106906



GENERATIONAL USA 50TG BRUIN - 1137133

- USA Made
- 1095 HC Steel
- Lockback Folder
- 2.8" Skinner Blade
- 6.5" Overall Length
- Nickel Silver Bolsters
- UPC: 641120106920



GENERATIONAL USA 940TG TRAPPER - 1137134

- USA Made
- 1095 HC Steel
- 2.4" Spy Blade
- 2.3" Clip Point Blade
- 5.4" Overall Length
- Nickel Silver Bolsters
- Generational Guarantee
- UPC: 641120106937



GENERATIONAL USA 340TG MIDDLEMAN - 1149090

- USA Made
- 1095 HC Steel
- 2.4" Clip Point Blade
- 2" Sheepfoot Blade
- 1.7" Pen Blade
- Nickel Silver Bolsters
- 7.2" Overall Length
- Nickel Silver Bolsters
- Generational Guarantee
- UPC: 641120107361





HERITAGE SERIES™

HERITAGE SERIES™ 50TH BRUIN - 1135989

- D2 Steel
- 2.8" Drop Point Blade
- Lockback Folder
- Nickel Silver Bolsters
- 6.5" Overall Length
- Laminate Wood Design
- UPC: 661120106883



HERITAGE SERIES™ 940TH TRAPPER - 1135990

- D2 Steel
- 3" Spay Blade
- 3" Clip Point Blade
- Nickel Silver Bolsters
- 6.1" Overall Length
- Laminate Wood Design
- UPC: 661120106890



HERITAGE SERIES™ 340TH MIDDLEMAN - 1149100

- D2 Steel
- 1.7" Pen Blade
- 2.4" Clip Point Blade
- 2" Sheepsfoot Blade
- 7.4" Overall Length
- Nickel Silver Bolsters
- Laminate Wood Design
- UPC: 661120107347



HERITAGE SERIES™ 1690TH FIXED BLADE - 1135992

- D2 Steel
- 5" Drop Point Blade
- Fitted Lather Sheath
- Nickel Silver Bolsters
- Laminate Wood Design with Saw Cut Style
- UPC: 661120106913



OLD TIMER® HUNTER KIT - 1135986

- 5.75" Saw Blade
- 3.75" Gut Hook Blade
- 8Cr Steel
- Fitted PP Sheath
- TPE Grip
- UPC: 661120107378



TRAIL BOSS™ FIXED BLADE - 1137135

- 8Cr Steel
- 3.75" Blade
- 4.62 Ounces
- Fitted PP Sheath
- Black and Green TPE Grip Handle
- Slimmer, Thinner Handle than Copperhead Series
- UPC: 661120107392



TRAIL BOSS™ FIXED BLADE GUT HOOK - 1137138

- 8Cr Steel
- 3.75" Blade
- 4.62 Ounces
- Fitted PP Sheath
- Black and Green TPE Grip Handle
- Slimmer, Thinner Handle than Copperhead Series
- UPC: 661120107415



TRAIL BOSS™ FIXED BLADE CAPING KNIFE - 1137140

- 8Cr Steel
- 3.5" Blade
- 4.57 Ounces
- Fitted PP Sheath
- Black and Green TPE Grip Handle
- Slimmer, Thinner Handle than Copperhead Series
- UPC: 661120107439



TRAIL BOSS™ DROP POINT FOLDER - 1137147

- 8Cr Steel
- 3" Blade
- 3.58 Ounces
- Black and Green TPE Grip Handle
- Slimmer, Thinner Handle than Copperhead Series
- UPC: 661120107453



TRAIL BOSS™ GUT HOOK FOLDER - 1137148

- 8Cr Steel
- 3" Blade
- 3.71 Ounces
- Black and Green TPE Grip Handle
- Slimmer, Thinner Handle than Copperhead Series
- UPC: 661120107477





FILLET KNIVES

LITHIUM-ION FILLET KNIFE - 1140756

- 1.25 Pounds
- Safety Lock
- ETL Approved
- Rechargeable Lithium-Ion
- 8" Stainless Steel Blades
- Carrying Bag Included
- UPC: 661120107491



ELECTRIC FILLET KNIFE - 1140755

- 110 Volt
- 1.5 Pounds
- Safety Lock
- 8 Foot Cord
- UL Approved
- 8" Stainless Steel Blades
- Carrying Bag Included
- UPC: 661120107507



RETURNING PRODUCTS



Built for Generations.™

REPLACEABLE BLADE GUT HOOK - 1123119

- TPE Rubber Handle
- Fits Standard Razor Blades
- 4 Replacement Blades
- Black Sheath for Gut Hook
- UPC: 661120081746



SWITCH-IT® SAW TOOTH HANDLE - 1123117

- 7Cr Steel
- Saw Tooth Handle
- Gut Hook
- Straight Blade
- Thumb Assist Open
- Sheath for Knife and Blades
- Blade Length: 3.3" (8.38 cm)
- Overall Length: 7.7" (19.56 cm)
- Weight: 5.4 oz.
- UPC: 661120081746



REPLACEABLE BLADE KIT - 1123115

- TPE Rubber Handle
- 60A Scalpel Blade
- 2 Saw Blades
- 2 Gut Hooks
- 4 Straight Blades
- Black Sheath for Knife and Blades
- Thumb Assist Opening
- Blade Length: 3.3" (8.3 cm)
- Overall Length: 7.7" (19.55 cm)
- Weight: 9 oz.
- UPC: 661120081722



REPLACEABLE BLADE - 1123114

- TPE Rubber Handle
- 60A Scalpel Blade
- 12 Spare Blades with Plastic Case
- Black Sheath for Knife and Blades
- Thumb Assist Opening
- Blade Length: 3.2" (8.1 cm)
- Overall Length: 7.7" (19.55 cm)
- Weight: 2.7 oz.
- UPC: 661120081715



REPLACEABLE BLADES - 1123129

- 12 60A Blades
- Stainless Steel
- Hard Shell Case
- Individually Wrapped



REPLACEABLE BLADES

LIGHTWEIGHT FIELD DRESSING KIT - 1123128

- 6" Boning Knife
- Knife Sharpener
- 4" Skinning Knife
- 5" Gut Hook Knife
- Plastic Carrying Case
- Field Dressing Gloves
- UPC: 661120102045



OUTDOOR KIT - 1123120

- Shears
- Bone Saw
- 7" Fillet Knife
- 6" Boning Knife
- Knife Sharpener
- 4" Skinning Knife
- 5" Gut Hook Knife
- Small Cutting Board
- Field Dressing Gloves
- Overall Length: 16.5" (8.5 cm)
- UPC: 661120081777





TRADITIONAL FOLDERS

SMALL LOCKBACK - 10T

- 7Cr High Carbon Stainless Steel
- Drop Point Blade
- Lockback
- Shackle
- Nickel Silver Bolsters
- Blade Length: 1.6" (4.0 cm)
- Overall Length: 3.6" (9.7 cm)
- Weight: 0.9 oz.
- UPC: 044356205252



BEARHEAD - 30T

- 7Cr High Carbon Stainless Steel
- Drop Point Blade
- Lockback
- Nickel Silver Bolsters
- Blade Length: 2.2" (5.6 cm)
- Overall Length: 5.1" (13.0 cm)
- Weight: 1.5 oz.
- UPC: 044356801329



BRUIN - 50T

- 7Cr High Carbon Stainless Steel
- Drop Point Blade
- Lockback
- Nickel Silver Bolsters
- Blade Length: 2.8" (7.1 cm)
- Overall Length: 6.5" (16.5 cm)
- Weight: 2.3 oz.
- UPC: 044356001243



GOLDEN BEAR® - 60T

- 7Cr High Carbon Stainless Steel
- Clip Point Blade
- Lockback
- Brass Bolsters
- Blade Length: 3.9" (9.9 cm)
- Overall Length: 8.7" (22.1 cm)
- Weight: 5.9 oz.
- UPC: 044356001039





TRADITIONAL FOLDERS

GOLDEN BEAR® - 60TW

- 7Cr High Carbon Stainless Steel
- Desert Iron wood Handle
- Brass Guard
- Lockback
- Leather Sheath
- Blade Length: 3.9" (9.9 cm)
- Overall Length: 8.7" (22.1 cm)
- Weight: 5.9 oz.
- UPC: 04435600244
- 60TWCP CLAM
 - UPC: 044356200301



CAVE BEAR - 70T

- 7Cr High Carbon Stainless Steel
- Clip Point Blade
- Lockback
- Nickel Silver Bolsters
- Leather Sheath
- Blade Length: 3.9" (9.9 cm)
- Overall Length: 8.7" (22.1 cm)
- Weight: 6.8 oz.
- UPC: 0443560013A2



SENIOR - 80T

- 7Cr High Carbon Stainless Steel
- Clip Point Blade
- Sheepfoot Blade
- Spy Blade
- Nickel Silver Bolsters
- Nylon Sheath
- Blade Length: 3" (7.6 cm)
- Overall Length: 6.9" (17.5 cm)
- Weight: 2.8 oz.
- UPC: 044356001113
- 80TCP CLAM
 - UPC: 044356001388



PAL - 120T

- 7Cr High Carbon Stainless Steel
- Clip Point Blade
- Nickel Silver Bolsters
- Blade Length: 2.2" (5.6 cm)
- Overall Length: 5.1" (13.0 cm)
- Weight: 1.1 oz.
- UPC: 044356001786
- 120TCP CLAM
 - UPC: 044356001456



HAWKBILL PRUNER - 160T

- 7Cr High Carbon Stainless Steel
- Hawkbill Blade
- Nickel Silver Bolsters
- Blade Length: 3" (7.6 cm)
- Overall Length: 7" (17.8 cm)
- Weight: 3.4 oz.
- UPC: 044356210249



MIGHTY MITE - 180T

- 7Cr High Carbon Stainless Steel
- Clip Point Blade
- Lockblade
- Nickel Silver Bolsters
- Blade Length: 2" (5.1 cm)
- Overall Length: 4.7" (11.9 cm)
- Weight: 1.0 oz.
- UPC: 044356001065
- 180TCP CLAM
 - UPC: 044356001403



SCOUT KNIFE - 230T

- 7Cr High Carbon Stainless Steel
- Drop Point Blade
- Can Opener
- Screwdriver and Cap Lifter
- Awl
- Shackle
- Nickel Silver Bolsters
- Blade Length: 2.4" (6.2 cm)
- Overall Length: 6.1" (15.5 cm)
- Weight: 3.5 oz.
- UPC: 044356228400



WOODWORKING KNIFE - 240T

- 65Mn High Carbon Steel
- Detail Blade
- Straight Gouge
- Hook Blade
- V-Scorp
- Gouge Scorp
- Chisel
- Nickel Silver Bolsters
- Blade Length: 1.5" (3.8 cm)
- Overall Length: 6" (15.3 cm)
- Weight: 3.9 oz.
- UPC: 044356228473
- 240TCP CLAM
 - UPC: 044356230001



FOLDING HUNTER - 250T

- 7Cr High Carbon Stainless Steel
- Clip Point Blade
- Sheepfoot Blade
- Nickel Silver Bolsters
- Leather Sheath
- Blade Length: 4" (10.2 cm)
- Overall Length: 9.3" (23.6 cm)
- Weight: 6.7 oz.
- UPC: 044356001274



MOUNTAIN BEAVER JR. - 280T

- 9Cr18MoV High Carbon S. S. Blade
- Rosewood/Ebony Handle
- Lockback
- Leather Sheath
- Nickel Silver Bolster
- Blade Length: 2.5" (6.4 cm)
- Overall Length: 6.1" (15.5 cm)
- Weight: 2.8 oz.
- UPC: 044356218887
- 280TCP CLAM
 - UPC: 044356219778



MOUNTAIN BEAVER SR. - 290T

- 9Cr18MoV High Carbon S. S. Blade
- Rosewood/Ebony Handle
- Lockback
- Leather Sheath
- Nickel Silver Bolster
- Blade Length: 3.2" (8.1 cm)
- Overall Length: 7.7" (19.6 cm)
- Weight: 5.1 oz.
- UPC: 044356218894
- 290TCP CLAM
 - UPC: 044356219785



LOCKBACK FOLDING KNIFE - 310T

- 7Cr High Carbon Stainless Steel
- Wood Handle
- Dual Thumb Knobs
- Lockback
- Pocket Clip
- Nickel Silver Bolster
- Blade Length: 2.9" (7.3 cm)
- Overall Length: 6.5" (16.5 cm)
- Weight: 3.2 oz.
- UPC: 044356229852
- 310TCP CLAM
 - UPC: 044356229869





TRADITIONAL FOLDERS

LOCKBACK FOLDING KNIFE - 320T

- 7Cr High Carbon Stainless Steel
- Wood Handle
- Dual Thumb Knobs
- Lockback
- Pocket Clip
- Nickel Silver Bolster
- Blade Length: 3.4" (8.6 cm)
- Overall Length: 7.7" (19.4 cm)
- Weight: 5 oz.
- UPC: 044356229876
320TCP CLAM
- UPC: 044356229883



MIDDLEMAN JACK - 330T

- 7Cr High Carbon Stainless Steel
- Clip Point Blade
- Pen Blade
- Nickel Silver Bolsters
- Blade Length: 2.4" (6.1 cm)
- Overall Length: 5.7" (14.5 cm)
- Weight: 1.7 oz.
- UPC: 044356801083
330TCP CLAM
- UPC: 044356001397



MIDDLEMAN - 340T

- 7Cr High Carbon Stainless Steel
- Clip Point Blade
- Sheepfoot Blade
- Pen Blade
- Nickel Silver Bolsters
- Blade Length: 2.4" (6.1 cm)
- Overall Length: 5.7" (14.5 cm)
- Weight: 1.8 oz.
- UPC: 044356001120
340TCP CLAM
- UPC: 044356001364



SADDLEMAN - 360T

- 7Cr High Carbon Stainless Steel
- Clip Point Blade
- Sheepfoot Blade
- Leather Punch
- Nickel Silver Bolsters
- Blade Length: 2.4" (6.1 cm)
- Overall Length: 5.7" (14.5 cm)
- Weight: 1.9 oz.
- UPC: 044356209311



WORKMATE - 440T

- 7Cr High Carbon Stainless Steel
- Clip Point Blade
- Sheepfoot Blade
- Pen Blade
- Wharncliffe Blade
- Nickel Silver Bolsters
- Blade Length: 2.2" (5.6 cm)
- Overall Length: 5.4" (13.7 cm)
- Weight: 1.8 oz.
- UPC: 044356205719



PREMIUM TRAPPER - 690T

- 7Cr High Carbon Stainless Steel
- Clip Point Blade
- Gut Hook
- Saw
- Nickel Silver Bolsters
- Blade Length: 3.3" (8.4 cm)
- Overall Length: 7.4" (18.8 cm)
- Weight: 4.8 oz.
- UPC: 044356200879
690TCP CLAM
- UPC: 044356209854



DOG LEG JACK - 720T

- 7Cr High Carbon Stainless Steel
- Clip Point Blade
- Pen Blade
- Nickel Silver Bolsters
- Blade Length: 2.3" (5.8 cm)
- Overall Length: 5.2" (13.2 cm)
- Weight: 1.4 oz.
- UPC: 044356001236



MUSKRAT - 770T

- 7Cr High Carbon Stainless Steel
- Clip Point Blade (2)
- Nickel Silver Bolsters
- Blade Length: 3" (7.6 cm)
- Overall Length: 6.9" (17.5 cm)
- Weight: 2.8 oz.
- UPC: 044356001186
- 770TCP CLAM
 - UPC: 044356001441



GUNSTOCK TRAPPER - 940T

- 7Cr High Carbon Stainless Steel
- Clip Point Blade
- Spy Blade
- Nickel Silver Bolsters
- Blade Length: 3" (7.6 cm)
- Overall Length: 6.9" (17.5 cm)
- Weight: 2.8 oz.
- UPC: 044356001038
- 940TCP CLAM
 - UPC: 044356002202



LARGE TRAPPER - 950T

- 7Cr High Carbon Stainless Steel
- Clip Point Blade
- Spy Blade
- Nickel Silver Bolsters
- Blade Length: 3.3" (8.4 cm)
- Overall Length: 7.4" (18.8 cm)
- Weight: 3.7 oz.
- UPC: 044356011284



BEARHEAD TRAPPER - 960T

- 7Cr High Carbon Stainless Steel
- Clip Point Blade
- Spy Blade
- Nickel Silver Bolsters
- Field Pick & Tweezers
- Blade Length: 3.3" (8.4 cm)
- Overall Length: 7.4" (18.8 cm)
- Weight: 3.7 oz.
- UPC: 044356001861



BUZZSAW TRAPPER - 970T

- 7Cr High Carbon Stainless Steel
- Clip Point Blade
- Saw
- Lockblade
- Nickel Silver Bolsters
- Leather Sheath
- Field Pick & Tweezers
- Blade Length: 3.7" (9.4 cm)
- Overall Length: 7.8" (19.8 cm)
- Weight: 4.8 oz.
- UPC: 044356002776





TRADITIONAL FOLDERS

SMALL CANOE - 1040T

- 7Cr High Carbon Stainless Steel
- Clip Point Blade
- Drop Point
- Nickel Silver Bolsters
- Blade Length: 2" (5.1 cm)
- Overall Length: 4.7" (11.9 cm)
- Weight: 1.0 oz.
- UPC: 044356001793
- 1040TCP CLAM
 - UPC: 044356001663



GRANDDAD'S - 1060T

- 7Cr High Carbon Stainless Steel
- Clip Point Blade
- Pen Blade
- Scissors
- Nickel Silver Bolsters
- Blade Length: 2" (5.1 cm)
- Overall Length: 4.8" (12.2 cm)
- Weight: 1.2 oz.
- UPC: 044356208345



JUNIOR - 1080T

- 7Cr High Carbon Stainless Steel
- Clip Point Blade
- Sheepfoot Blade
- Pen Blade
- Nickel Silver Bolsters
- Blade Length: 2" (5.1 cm)
- Overall Length: 4.7" (11.9 cm)
- Weight: 1.2 oz.
- UPC: 044356001057
- 1080TCP CLAM
 - UPC: 044356001373



LARGE CANOE - 1100T

- 7Cr High Carbon Stainless Steel
- Drop Point
- Pen Blade
- Nickel Silver Bolsters
- Blade Length: 2.5" (6.4 cm)
- Overall Length: 6.1" (15.5 cm)
- Weight: 2.5 oz.
- UPC: 044356209166



PIONEER - 1230T

- 7Cr High Carbon Stainless Steel
- Clip Point Blade
- Lanyard Hole
- Nickel Silver Bolsters
- Blade Length: 3.1" (7.9 cm)
- Overall Length: 7.1" (18.0 cm)
- Weight: 2.5 oz.
- UPC: 044356209180



MUSTANG - 1250T

- 7Cr High Carbon Stainless Steel
- Clip Point Blade
- Nickel Silver Bolsters
- Leather Sheath
- Blade Length: 4" (10.2 cm)
- Overall Length: 9.3" (23.6 cm)
- Weight: 4.8 oz.
- UPC: 044356002134



GUNSTOCK TRAPPER - 1940T

- 7Cr High Carbon Stainless Steel
- Clip Point Blade
- Lockblade
- Nickel Silver Bolsters
- Blade Length: 3.1" (7.9 cm)
- Overall Length: 7" (17.8 cm)
- Weight: 2.4 oz.
- UPC: 044356201069
- 1940TCP CLAM
 - UPC: 044356207812



PIONEER - 2230T

- 7Cr High Carbon Stainless Steel
- Clip Point Blade w/ Thumb Knob
- Lockblade
- Pocket Clip
- Nickel Silver Bolsters
- Blade Length: 3.1" (7.9 cm)
- Overall Length: 7.2" (18.3 cm)
- Weight: 3.4 oz.
- UPC: 044356220385



BARLOW - 2800T

- 7Cr High Carbon Stainless Steel
- Clip Point Blade
- Pen Blade
- Nickel Silver Bolsters
- Blade Length: 2.3" (5.8 cm)
- Overall Length: 5.7" (14.5 cm)
- Weight: 2.6 oz.
- UPC: 044356205061



LINER LOCK TRAPPER - 2940T

- 7Cr High Carbon Stainless Steel
- Clip Point Blade w/ Thumb Knob
- Lockblade
- Pocket Clip
- Nickel Silver Bolsters
- Blade Length: 3.1" (7.9 cm)
- Overall Length: 7.2" (18.3 cm)
- Weight: 3.4 oz.
- UPC: 044356220378



TRAPPER - 2960T

- 7Cr High Carbon Stainless Steel
- Clip Point Blade
- Spy Blade
- Nickel Silver Bolsters
- Blade Length: 3.2" (8.1 cm)
- Overall Length: 7.3" (18.5 cm)
- Weight: 3.9 oz.
- UPC: 044356216104



LUMBERJACK - 8580T

- 7Cr High Carbon Stainless Steel
- Clip Point Blade
- Sheepfoot Blade
- Spy Blade
- Nickel Silver Bolsters
- Blade Length: 2.8" (7.1 cm)
- Overall Length: 7.4" (18.8 cm)
- Weight: 4.8 oz.
- UPC: 044356205129





SENIOR - 80TB

- Mirror-Polished 9Cr18MoV High Carbon S.S.
- Clip Point Blade
- Sheepfoot Blade
- Spy Blade
- Saw Cut Bone Handle
- Nickel Silver Bolsters
- Blade Length: 3" (7.5 cm)
- Overall Length: 4.9" (11.5 cm)
- Weight: 3.0 oz.
- UPC: 044356222853



MIDDLEMAN - 340TB

- Mirror-Polished 9Cr18MoV High Carbon S.S.
- Clip Point Blade
- Sheepfoot Blade
- Pen Blade
- Saw Cut Bone Handle
- Nickel Silver Bolsters
- Blade Length: 2.4" (6.1 cm)
- Overall Length: 5.6" (14.3 cm)
- Weight: 1.8 oz.
- UPC: 044356222297
- 340TBCP CLAM**
 - UPC: 044356223997



DOG LEG JACK - 720TB

- Mirror-Polished 9Cr18MoV High Carbon S.S.
- Clip Point Blade
- Pen Blade
- Saw Cut Bone Handle
- Nickel Silver Bolsters
- Blade Length: 2.3" (5.7 cm)
- Overall Length: 5.1" (13.0 cm)
- Weight: 1.6 oz.
- UPC: 044356222945



LUMBERJACK STOCKMAN - 8580TB

- Mirror-Polished 9Cr18MoV High Carbon S.S.
- Clip Point Blade
- Sheepfoot Blade
- Spy Blade
- Saw Cut Bone Handle
- Nickel Silver Bolsters
- Blade Length: 3.4" (8.7 cm)
- Overall Length: 7.9" (20.2 cm)
- Weight: 4.6 oz.
- UPC: 044356222200



GUNSTOCK TRAPPER - 940TB

- Mirror-Polished 9Cr18MoV High Carbon S.S.
- Clip Point Blade
- Spy Blade
- Saw Cut Bone Handle
- Nickel Silver Bolsters
- Blade Length: 3" (7.7 cm)
- Overall Length: 4.8" (11.4 cm)
- Weight: 2.0 oz.
- UPC: 044356222273



LARGE TRAPPER - 950TB

- Mirror-Polished 9Cr18MoV High Carbon S.S.
- Clip Point Blade
- Spy Blade
- Saw Cut Bone Handle
- Nickel Silver Bolsters
- Blade Length: 3.1" (8.0 cm)
- Overall Length: 7.3" (18.6 cm)
- Weight: 3.5 oz.
- UPC: 044356222303





TRADITIONAL FOLDERS

SENIOR - 80TY

- 7Cr High Carbon Stainless Steel
- Clip Point Blade
- Sheepfoot Blade
- Spy Blade
- Old Timer® Yellow Handle
- Nickel Silver Bolsters
- Blade Length: 3" (7.6 cm)
- Overall Length: 6.9" (17.5 cm)
- Weight: 2.0 oz.
- UPC: 044356001328



MIDDLEMAN JACK - 330TY

- 7Cr High Carbon Stainless Steel
- Clip Point Blade
- Pan Blade
- Old Timer® Yellow Handle
- Nickel Silver Bolsters
- Blade Length: 2.4" (6.1 cm)
- Overall Length: 5.7" (14.5 cm)
- Weight: 1.7 oz.
- UPC: 044356000543
- 330TYCP CLAM**
 - UPC: 044356210029

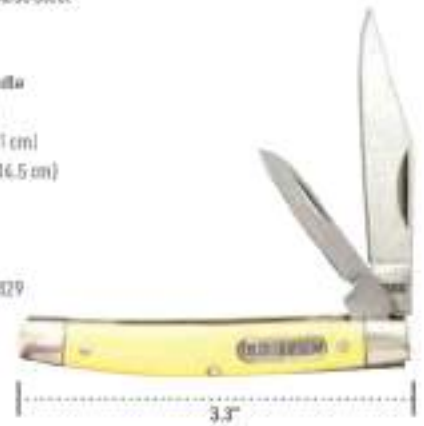

GUNSTOCK TRAPPER - 940TY

- 7Cr High Carbon Stainless Steel
- Clip Point Blade
- Spy Blade
- Old Timer® Yellow Handle
- Nickel Silver Bolsters
- Blade Length: 3" (7.6 cm)
- Overall Length: 6.9" (17.5 cm)
- Weight: 2.5 oz.
- UPC: 044356000536
- 940TYCP CLAM**
 - UPC: 044356210050



YELLOW HANDLE



TRADITIONAL FOLDERS

SENIOR - 80TW

- 7Cr High Carbon Stainless Steel
- Clip Point Blade
- Sheepfoot Blade
- Spy Blade
- Desert Iron Wood Handle
- Nickel Silver Bolsters
- Blade Length: 3" (7.6 cm)
- Overall Length: 6.9" (17.5 cm)
- Weight: 2.6 oz.
- UPC: 04435600208



MIDDLEMAN JACK - 330TW

- 7Cr High Carbon Stainless Steel
- Clip Point Blade
- Pen Blade
- Desert Iron Wood Handle
- Nickel Silver Bolsters
- Blade Length: 2.4" (6.1 cm)
- Overall Length: 5.7" (14.5 cm)
- Weight: 1.7 oz.
- UPC: 044356203487



MIDDLEMAN - 340TW

- 7Cr High Carbon Stainless Steel
- Clip Point Blade
- Pen Blade
- Desert Iron Wood Handle
- Nickel Silver Bolsters
- Blade Length: 2.4" (6.1 cm)
- Overall Length: 5.7" (14.5 cm)
- Weight: 1.8 oz.
- UPC: 04435600192



GUNSTOCK TRAPPER - 940TW

- 7Cr High Carbon Stainless Steel
- Clip Point Blade
- Spy Blade
- Desert Iron Wood Handle
- Nickel Silver Bolsters
- Blade Length: 3" (7.6 cm)
- Overall Length: 6.9" (17.5 cm)
- Weight: 2.5 oz.
- UPC: 04435600222





ASSISTED OPENING

PAKKAWOOD FOLDER - 1084273

- 7Cr High Carbon Stainless Steel
- Pakkawood Handle
- Dual Thumbstuds
- Satin Blade Finish
- Nickel Silver Caps
- Lanyard Hole
- Pocket Clip
- Blade Length: 2.9" (7.6 cm)
- Overall Length: 6.85" (17.4 cm)
- Weight: 4.4 oz.
- UPC - 661120413240
- 1084274 - Clam Pack
 - UPC - 661120413257



PAKKAWOOD FOLDER - 1084275

- 7Cr High Carbon Stainless Steel
- Pakkawood Handle
- Dual Thumbstuds
- Satin Blade Finish
- Nickel Silver Inlay
- Lanyard Hole
- Pocket Clip
- Blade Length: 2.9" (7.5 cm)
- Overall Length: 7.32" (18.6 cm)
- Weight: 4.3 oz.
- UPC - 661120413264
- 1084276 - Clam Pack
 - UPC - 661120413270





ASSISTED OPENING

SAW CUT ASSISTED KNIFE - 1084277

- 7Cr17MoV High Carbon S.S. Blade
- Saw cut Ironwood Handle
- Dual Thumbstud
- Satin Blade Finish
- Nickel Silver Bolster
- Saw Cut Handle
- Lanyard Hole
- Pocket Clip
- Blade Length: 2.9" (7.5 cm)
- Overall Length: 6.89" (17.5 cm)
- Weight: 3.8 oz.
- UPC - 661120413387
- 1084278 - Clam Pack
 - UPC - 661120413394



6.89"



3.94"

OT WOOD TI-NITRIDE S.A. - 1100026

- 7Cr17MoV HIGH CARBON S.S., TI-NITRIDE Blade,
- Iron wood Handle
- Spring-Assisted Opening
- Thumbstud
- Pocket Clip
- Blade Length: 3" (7.62 cm)
- Overall Length: 7" (17.78 cm)
- Weight: 3.6 oz.
- UPC - 661120418878
- 1100027 - Clam Pack
 - UPC - 661120875783



7"



4"



ASSISTED OPENING

OT ROSEWOOD S.A. - 1100030

- 7Cr17MoV HIGH CARBON S.S., BEAD BLAST Blade,
- ROSEWOOD Handle
- Spring-Assisted Opening
- Thumbstud
- Pocket Clip
- Lanyard Hole
- Blade Length: 3" (7.62 cm)
- Overall Length: 7" (17.78 cm)
- Weight: 3.3 oz.
- UPC - 661120075790
- 1100031 - Clam Pack
 - UPC - 661120075806



OT IRONWOOD & NICKEL - 1100028

- 7Cr17MoV HIGH CARBON S.S., SATIN Blade,
- Iron wood Handle
- Thumbstud
- Nickel Silver Bolster
- Liner Lock
- Pocket Clip
- Blade Length: 3" (7.62 cm)
- Overall Length: 7" (17.78 cm)
- Weight: 4.6 oz.
- UPC - 661120075813
- 1100029 - Clam Pack
 - UPC - 661120075820





FIXED BLADE

CAPYBARA® - 300T

- 9Cr18MoV High Carbon S.S. Blade
- Rosewood/Ebony Handle
- Brass Guard
- Full Tang
- Leather Sheath
- Blade Length: 4" (10.2 cm)
- Overall Length: 8.5" (21.5 cm)
- Weight: 6.3 oz.
- UPC: 044356224918
- 30TCP
- UPC: 044356225717





FIXED BLADE

DEERSLAYER - 150T

- 7Cr17MoV High Carbon S.S. Blade
- Full Tang
- OT Saw Cut Handle
- Leather Sheath
- Blade Length: 5.4" (13.7 cm)
- Overall Length: 10.5" (26.7 cm)
- Weight: 7.7 oz.
- UPC: 044356001175
- 150TCP
- UPC: 044356001307



SHARPFINGER® - 1520T

- 7Cr17MoV High Carbon S.S. Blade
- Full Tang
- OT Saw Cut Handle
- Leather Sheath
- Blade Length: 3.3" (8.4 cm)
- Overall Length: 7.1" (18.0 cm)
- Weight: 3.1 oz.
- UPC: 044356001168
- 1520TCP
- UPC: 044356001427



LARGE SHARPFINGER® - 1520TL

- 7Cr17MoV High Carbon S.S. Blade
- Full Tang
- OT Saw Cut Handle
- Leather Sheath
- Blade Length: 4" (10.1 cm)
- Overall Length: 8.6" (21.8 cm)
- Weight: 6.0 oz.
- UPC: 044356226264
- 1520TCP
- UPC: 044356226271





FIXED BLADE

LIL' FINGER - 1560T

- 7Cr17MoV High Carbon S.S. Blade
- Full Tang
- OT Saw Cut Handle
- Leather Sheath
- Nickel Silver Bolster
- Blade Length: 2.5" (6.3 cm)
- Overall Length: 6.6" (16.7 cm)
- Weight: 3.9 oz.
- UPC: 044356204693



GUT HOOK SKINNER - 1580T

- Blade Length: 3.5" (8.9 cm)
- Overall Length: 7.3" (18.5 cm)
- Weight: 3.3 oz.
- UPC: 044356001250
1580TCP
- UPC: 044356001519



MOUNTAIN LION - 1600T

- Nickel Silver Bolster
- Blade Length: 5" (12.7 cm)
- Overall Length: 9.3" (23.6 cm)
- Weight: 6.9 oz.
- UPC: 044356001201





FIXED BLADE

BOOT KNIFE - 1620T

- 7Cr17MoV High Carbon S.S. Blade
- Full Tang
- OT Saw Cut Handle
- Leather Sheath
- Nickel Silver Bolster
- Blade Length: 3.8" (9.6 cm)
- Overall Length: 7.8" (19.8 cm)
- Weight: 3.9 oz.
- UPC: 044356204705
- No Ship CA, NY, MA



WOODSMAN - 1650T

- Nickel Silver Bolster
- Blade Length: 5" (12.7 cm)
- Overall Length: 9.3" (23.6 cm)
- Weight: 8.3 oz.
- UPC: 044356008314



OT 993 FIXED - 1100032

- 7Cr17MoV HIGH CARBON S.S., SATIN Blade,
- SAW CUT Handle
- Full Tang
- Black, Leather Sheath
- Lanyard Hole
- Blade Length: 4" (10.16 cm)
- Overall Length: 8" (20.32 cm)
- Weight: 2.9 oz.
- UPC: 661120075837
1100032
- UPC: 661120075844



Uncle Henry®
2021 NEW PRODUCTS

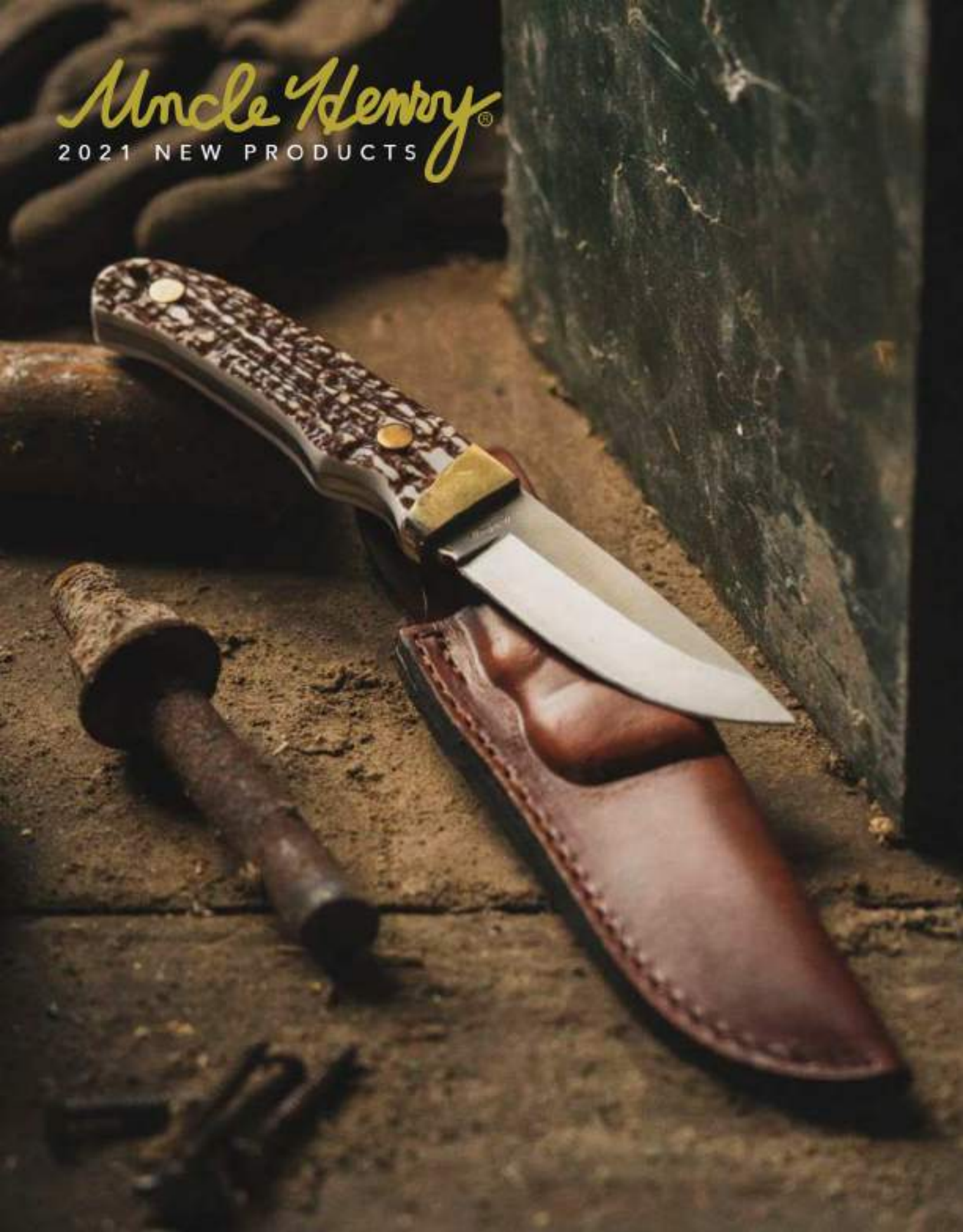

897UH Premium Stock

Next Gen Staglon®

- New, realistic Staglon® handles
- Overall length - 6.2"
- Blade length - 2.8"
- Overall weight - 2.1 oz
- 7Cr17MoV High Carbon Stainless Steel

Item: 1136004 UPC: 661120260301
Packaging Size: 3.7" x 1.2" x 0.8" Case Pack: 3



227UH Folding Bowie

Next Gen Staglon®

- New, realistic Staglon® handles
- Overall length - 9.3"
- Blade length - 4"
- Overall weight - 6.7 oz
- 7Cr17MoV High Carbon Stainless Steel

Item: 1135997 UPC: 661120260233
Packaging Size: 6.1" x 2.6" x 1.7" Case Pack: 3



885UH Sr. Rancher®

Next Gen Staglon®

- New, realistic Staglon® handles
- Overall length - 6.9"
- Blade length - 3"
- Overall weight - 2.8 oz
- 7Cr17MoV High Carbon Stainless Steel

Item: 1136003 UPC: 661120260295
Packaging Size: 4.4" x 1.4" x 0.9" Case Pack: 3



LB8 Papa Bear

Next Gen Staglon®

- New, realistic Staglon® handles
- Overall length - 8.7"
- Blade length - 3.7"
- Overall weight - 6.9 oz
- 7Cr17MoV High Carbon Stainless Steel

BOX

Item: 1136005 UPC: 661120260318

Packaging Size: 6.15" x 2.6" x 1.7" Case Pack: 3



LB8CP Bear Paw

CLAM PACK

Item: 1136006 UPC: 661120260325

Packaging Size: 5.23" x 1.45" x 12.24" Case Pack: 3

807UH Junior

Next Gen Staglon®

- New, realistic Staglon® handles
- Overall length - 4.8"
- Blade length - 2"
- Overall weight - 1.1 oz
- 7Cr17MoV High Carbon Stainless Steel

Item: 1136001 UPC: 661120260271

Packaging Size: 3.8" x 1.2" x 0.8" Case Pack: 3



16UH Hawkbill Pruner

Next Gen Staglon®

- New, realistic Staglon® handles
- Overall length - 7"
- Blade length - 3"
- Overall weight - 3.4 oz
- 7Cr17MoV High Carbon Stainless Steel

Item: 1135996 UPC: 661120260226

Packaging Size: 4.2" x 2" x 0.6" Case Pack: 3



285UH Pro Trapper

Next Gen Staglon®

- New, realistic Staglon® handles
- Overall length - 7"
- Blade length - 3.2"
- Overall weight - 2.8 oz
- 7Cr17MoV High Carbon Stainless Steel

Item: 1135999 UPC: 661120260257

Packaging Size: 4.3" x 1.4" x 0.9" Case Pack: 3



834UH Rancher®

Next Gen Staglon®

- New, realistic Staglon® handles
- Overall length - 5.8"
- Blade length - 2.5"
- Overall weight - 1.8 oz
- 7Cr17MoV High Carbon Stainless Steel

Item: 1136002 UPC: 661120260288

Packaging Size: 3.7" x 1.2" x 0.8" Case Pack: 3



5UH Bruin

Next Gen Staglon®

- New, realistic Staglon® handles
- Overall length - 6.5"
- Blade length - 2.8"
- Overall weight - 2.6 oz
- 7Cr17MoV High Carbon Stainless Steel

Item: 1136000 UPC: 661120260264

Packaging Size: 5.2" x 2" x 1.3" Case Pack: 3



12UH Roadie

Next Gen Staglon®

- New, realistic Staglon® handles
- Overall length - 5.1"
- Blade length - 2.2"
- Overall weight - 0.9 oz
- 7Cr17MoV High Carbon Stainless Steel

Item: 1135995 UPC: 661120260219

Packaging Size: 3.7" x 1.2" x 0.8" Case Pack: 3



11UH LG Canoe

Next Gen Staglon®

- New, realistic Staglon® handles
- Overall length - 6.1"
- Blade length - 2.5"
- Overall weight - 2.5 oz
- 7Cr17MoV High Carbon Stainless Steel

Item: 1135994 UPC: 661120260202

Packaging Size: 4.5" x 1.4" x 0.9" Case Pack: 3



23UH Scout

Next Gen Staglon®

- New, realistic Staglon® handles
- Overall length - 6.12"
- Blade length - 2.44"
- Overall weight - 3.5 oz
- 7Cr17MoV High Carbon Stainless Steel

Item: 1135998 UPC: 661120260240

Packaging Size: 4" x 1.21" x 1.02" Case Pack: 3





Uncle Henry®
RETURNING PRODUCTS

NEXT GEN STAGLON® 182UH

7Cr17MoV HIGH CARBON S.S. BLADE

- Fixed Blade
- Realistic Staglon® Handles
- Leather Sheath Included

Blade Length
3.8" (9.67 cm)
Overall Length
8.4" (21.34 cm)
Weight
6.3 oz.



1116404 NEXT GEN STAGLON® 182UH

UPC - 661120078722

1116405 NEXT GEN STAGLON® 182UH TRAP BLISTER

UPC - 661120078739



NEXT GEN STAGLON® 183UH

7Cr17MoV HIGH CARBON S.S. BLADE

- Fixed Blade
- Realistic Staglon® Handles
- Leather Sheath Included

Blade Length
4.6" (11.68 cm)
Overall Length
9.1" (23.11 cm)
Weight
7.8 oz.



1116408 NEXT GEN STAGLON® 183UH

UPC - 661120078746



NEXT GEN STAGLON® 185UH

7Cr17MoV HIGH CARBON S.S. BLADE

- Fixed Blade
- Realistic Staglon® Handles
- Leather Sheath Included

Blade Length
4.3" (10.92 cm)
Overall Length
9.1" (23.11 cm)
Weight
7.8 oz.



1116410 NEXT GEN STAGLON® 185UH

UPC - 661120078753

1116412 NEXT GEN STAGLON® 185UH TRAP BLISTER

UPC - 661120078760



NEXT GEN STAGLON® 162UH
7Cr17MoV HIGH CARBON S.S. BLADE

- Fixed Blade
- Realistic Staglon® Handles
- Leather Sheath Included

Blade Length
3.4" (8.64 cm)
Overall Length
7.4" (18.80 cm)
Weight
3.9 oz.



1116414 NEXT GEN STAGLON® 162UH
UPC - 661120078777

NEXT GEN STAGLON® PH1N
7Cr17MoV HIGH CARBON S.S. BLADE

- Fixed Blade
- Realistic Staglon® Handles
- Leather Sheath Included

Blade Length
3.6" (9.14 cm)
Overall Length
8.1" (20.57 cm)
Weight
6.9 oz.



1116418 NEXT GEN STAGLON® PH1N
UPC - 661120078883
1116420 NEXT GEN STAGLON® PH1N TRAP BLISTER
UPC - 661120078890

1116424 **NEXT GEN STAGLON® 181UH**
7Cr17MoV HIGH CARBON S.S. BLADE

- Fixed Blade
- Realistic Staglon® Handles
- Nylon Sheath Included

Blade Length
10" (25.4 cm)
Overall Length
15.4" (39.11 cm)
Weight
16.2 oz.



1116424 NEXT GEN STAGLON® 181UH
UPC - 661120078906
1116426 NEXT GEN STAGLON® 181UH TRAP BLISTER
UPC - 661120078913

NEXT GEN STAGLON® 167UH

7Cr17MoV HIGH CARBON S.S. BLADE

- Fixed Blade
- Realistic Staglon® Handles
- Leather Sheath Included

Blade Length
7.5" (19.05 cm)
Overall Length
12" (30.48 cm)
Weight
4.1 oz.



1116434 **NEXT GEN STAGLON® 167UH**
UPC - 661120078944
1116432 **NEXT GEN STAGLON® 167UH TRAP BLISTER**
UPC - 661120078937

NEXT GEN STAGLON® 168UH

7Cr17MoV HIGH CARBON S.S. BLADE

- Fixed Blade
- Realistic Staglon® Handles
- Leather Sheath Included

Blade Length
5.3" (13.46 cm)
Overall Length
10.1" (25.65 cm)
Weight
2.9 oz.



1116438 **NEXT GEN STAGLON® 168UH**
UPC - 661120078968
1116436 **NEXT GEN STAGLON® 168UH TRAP BLISTER**
UPC - 661120078951

22UH

DELUXE WOOD CARVING KIT

65MN HIGH CARBON BLADES WOOD HANDLE

- 6SBL Blade Pack of (6) Small Detail Blades
 - 20E x 15/16" Radius Ground on Outside Curve
 - 21EX Straight Blade
 - 11 Straight Blade Ground on Slanted Edge
 - 10 1" Radius Ground on Inside Curve
 - 8 2" Radius Ground on Inside Curve
 - 22 2" Radius Ground on Inside Curve
- (1) - LD2 1/2" x .05" Heavy-Duty Blade
- (1) - LN3 1/2" x .05" Carving Blade
- (1) - LS1 1/2" x .05" Carving Blade
- (1) - LB0 #7 Sweep Gouge 5/16" Cut

Handle Length
4.6" (11.7 cm)

Weight
12.8 oz.

UPC
044356228510



Three Way Brass Jaw
Chuckling System

- 7Cr17MoV High Carbon S.S.
- Drop Point Blade
- Can Opener
- Screwdriver and Cap Lifter
- Awl
- Shackle
- Nickel Silver Bolsters



3.6"

23UH

SCOUT KNIFE

Blade Length 2.4" (6.2 cm) Weight 3.5 oz.
Overall Length 6.1" (15.5 cm) UPC 044356228497

- 7Cr17MoV High Carbon S.S.
- Sheepsfoot Blade (2)
- Pen Blade
- Coping Blade
- Nickel Silver Bolsters



3.5"

4UH

MASTER

Blade Length 2.3" (5.8 cm) Weight 2.6 oz.
Overall Length 5.8" (14.7 cm) UPC 044356000437

- 7Cr17MoV High Carbon S.S.
- Clip Point Blade
- Sheepsfoot Blade
- Pen Blade
- Nickel Silver Bolsters



2.8"

867UH

JUNIOR

Blade Length 2" (5.1 cm) Weight 1.1 oz.
Overall Length 4.8" (12.2 cm) UPC 044356003162

- 7Cr17MoV High Carbon S.S.
- Clip Point Blade
- Sheepsfoot Blade
- Pen Blade
- Nickel Silver Bolsters



3.3"

834UH

THE RANCHER®

Blade Length 2.5" (6.4 cm) Weight 1.8 oz.
Overall Length 5.8" (14.7 cm) UPC 044356003193

- 7Cr17MoV High Carbon S.S.
- Clip Point Blade
- Sheepsfoot Blade
- Spey Blade
- Nickel Silver Bolsters



3.9"

8850H

SENIOR RANCHER

Blade Length 3" (7.6 cm) Weight 2.8 oz.
Overall Length 6.8" (17.5 cm) UPC 044356003049

- 7Cr17MoV High Carbon S.S.
- Clip Point Blade
- Pen Blade
- Shackle
- Nickel Silver Bolsters



2.8"

8040H

JOURNEYMAN

Blade Length 2" (5.1 cm) Weight 1.1 oz.
Overall Length 4.6" (12.2 cm) UPC 044356003506

- 7Cr17MoV High Carbon S.S.
- Clip Point Blade
- Sheepsfoot Blade
- Spey Blade
- Nickel Silver Bolsters



3.5"

8970H

PREMIUM STOCK

Blade Length 2.8" (7.1 cm) Weight 2.1 oz.
Overall Length 6.2" (15.7 cm) UPC 044356003056

- 7Cr17MoV High Carbon S.S.
- Clip Point Blade
- Sheepsfoot Blade
- Spey Blade
- Stainless Steel Bolsters



3.5"

8970HP

PREMIUM STOCK

Blade Length 2.8" (7.1 cm) Weight 2.3 oz.
Overall Length 6.2" (15.7 cm) UPC 044356212830

- 7Cr17MoV High Carbon S.S.
- Clip Point Blade
- Gut Hook
- Lockblade
- Nickel Silver Bolsters



4"

8770H

MUSKRAT GUTHOOK

Blade Length 3" (7.6 cm) Weight 2.8 oz.
Overall Length 7" (17.8 cm) UPC 044356206574

- 7Cr17MoV High Carbon S.S.
- Drop Point Blade
- Pen Blade
- Nickel Silver Bolsters
- Leather Sheath



3.6"

110H

LARGE CANOE

Blade Length 2.5" (6.4 cm) Weight 2.5 oz.
Overall Length 6.1" (15.5 cm) UPC 044356209168

- 7Cr17MoV High Carbon S.S.
- Drop Point Blade
- Clip Point Blade
- Nickel Silver Bolsters
- Leather Sheath



5.3"

227UH

FOLDING BOWIE

Blade Length 4" (10.2 cm) Weight 6.7 oz
Overall Length 9.3" (23.6 cm) UPC 044356201704

- 7Cr17MoV High Carbon S.S.
- Clip Point Blade
- Spey Blade
- Nickel Silver Bolsters



3.9"

285UH

PRO TRAPPER

Blade Length 3.2" (8.1 cm) Weight 2.8 oz
Overall Length 7" (17.8 cm) UPC 044356003025

- 7Cr17MoV High Carbon S.S.
- Clip Point Blade
- Shackle
- Nickel Silver Bolsters



3"

12UH

ROADIE

Blade Length 2.2" (5.6 cm) Weight 0.9 oz
Overall Length 5.1" (13.0 cm) UPC 044356003247

- 7Cr17MoV High Carbon S.S.
- Drop Point Blade
- Lockback
- Nickel Silver Bolsters



3.7"

5UH

BRUIN

Blade Length 2.8" (7.1 cm) Weight 2.8 oz
Overall Length 6.5" (16.5 cm) UPC 044356021364

- 7Cr17MoV High Carbon S.S.
- Hawkbill Blade
- Nickel Silver Bolsters



4"

16UH

HAWKBILL PRUNER

Blade Length 3" (7.6 cm) Weight 3.4 oz
Overall Length 7" (17.8 cm) UPC 044356210256

- 7Cr17MoV High Carbon S.S.
- Clip Point Blade
- Shackle
- Lockback
- Nickel Silver Bolsters



2.2"

LD2

SMOKEY

Blade Length 1.5" (3.8 cm) Weight 1.1 oz
Overall Length 3.8" (9.7 cm) UPC 044356014090

LBI

CUB

7Cr17MoV HIGH CARBON S.S. BLADE

WOOD HANDLE

- Clip Point Blade
- Shadde
- Lockback
- Nickel Silver Bolsters

Blade Length

1.5" (3.8 cm)

Overall Length

3.8" (9.7 cm)

Weight

1.1 oz.

UPC

044356014007



BROWN BEAR

7Cr17MoV HIGH CARBON S.S. BLADE

WOOD HANDLE

- Clip Point Blade
- Lockback
- Nickel Silver Bolsters

Blade Length

2.2" (5.6 cm)

Overall Length

5.1" (13.0 cm)

Weight

1.6 oz.



LB3 BROWN BEAR BOX

UPC - 044356014014

LB3CP BROWN BEAR CLAM

UPC - 044356014182

SMOKEY II

7Cr17MoV HIGH CARBON S.S. BLADE

WOOD HANDLE

- Clip Point Blade
- Lockback
- Nickel Silver Bolsters
- Leather Sheath

Blade Length

2.8" (7.1 cm)

Overall Length

6.5" (16.5 cm)

Weight

3.1 oz.



LB5 SMOKEY II BOX

UPC - 044356014021

LB5CP SMOKEY II CLAM PACK

UPC - 044356014199



BEAR PAW

7Cr17MoV HIGH CARBON S.S. BLADE

WOOD HANDLE

- Clip Point Blade
- Lockback
- Brass Bolsters
- Leather Sheath



Blade Length
3.7" (9.4 cm)
Overall Length
8.7" (22.1 cm)
Weight
7.6 oz.



LB7 BEAR PAW BOX
UPC - 044358014038
LB7CP BEAR PAW CLAM
UPC - 044358014151

PAPA BEAR

7Cr17MoV HIGH CARBON S.S. BLADE

STAGLON® HANDLE

- Clip Point Blade
- Lockback
- Brass Bolsters
- Leather Sheath



Blade Length
3.7" (9.4 cm)
Overall Length
8.7" (22.1 cm)
Weight
8.9 oz.



LB8 PAPA BEAR BOX
UPC - 044358224901
LB8CP PAPA BEAR CLAM
UPC - 044358227377

ELK HUNTER® DROP POINT

7CR17MOV HIGH CARBON S.S. BLADE

STAGLON® HANDLE

- Full Tang
- Brass Guard and Pommel
- Leather Belt Sheath

Blade Length
3.8" (9.7 cm)
Overall Length
8.4" (21.4 cm)
Weight
6.3 oz.



8.4"



182UH ELK HUNTER® DROP POINT BOX

UPC - 044356222778

182UHCP ELK HUNTER® DROP POINT CLAM

UPC - 044356224345

ELK HUNTER® SKINNER

7CR17MOV HIGH CARBON S.S. BLADE

STAGLON® HANDLE

- Full Tang
- Brass Guard
- Leather Belt Sheath

Blade Length
4.6" (11.7 cm)
Overall Length
9.1" (23.1 cm)
Weight
7.8 oz.



9.1"



183UH ELK HUNTER® SKINNER BOX

UPC - 044356222785

GOLDEN SPIKE

7Cr17MoV HIGH CARBON S.S. BLADE

STAGLON® HANDLE

- Full Tang
- Nickel Silver Bolsters
- Sharpening Stone
- Leather Sheath

Blade Length
5" (12.7 cm)
Overall Length
9.4" (23.9 cm)
Weight
6.3 oz.



9.4"



153UH GOLDEN SPIKE BOX

UPC - 044358003063

153UHCP GOLDEN SPIKE CLAM

UPC - 044356990592

UNCLE HENRY® GUT HOOK

7Cr17MoV HIGH CARBON S.S. BLADE
STAGLON® HANDLE

- Full Tang
- Brass Guard
- Leather Belt Sheath

Blade Length
4.3" (10.8 cm)
 Overall Length
9.1" (23.0 cm)
 Weight
7.8 oz.



9.1"

185UH **UNCLE HENRY® GUT HOOK BOX**
 UPC - 044356229647
185UHCP **UNCLE HENRY® GUT HOOK CLAM**
 UPC - 044356229654



DETAIL SKINNER

7Cr17MoV HIGH CARBON S.S. BLADE
STAGLON® HANDLE

- Full Tang
- Leather Belt Sheath

Blade Length
3.1" (7.9 cm)
 Overall Length
6.5" (16.5 cm)
 Weight
2.5 oz.



6.5"

301UH **DETAIL SKINNER BOX**
 UPC - 044356225731
301UHCP **DETAIL SKINNER CLAM**
 UPC - 044356227629



WOLVERINE

7Cr17MoV HIGH CARBON S.S. BLADE
STAGLON® HANDLE

- Full Tang
- Nickel Silver Bolster
- Leather Sheath

Blade Length
3.4" (8.6 cm)
 Overall Length
7.4" (18.8 cm)
 Weight
3.9 oz.



7.4"

162UH **WOLVERINE**
 UPC - 044356211239



1085923

2202UH STAG HORN FIXED BLADE

D2 STEEL SATIN FINISH BLADE

STAG HORN HANDLE

- Full Tang
- Brass Pins
- Lanyard Hole
- Leather Sheath

Blade Length
2.75" (6.99 cm)
Overall Length
6.25" (15.875 cm)
Weight
3.6 oz.
UPC
661120414421



6.25"



1085924

2203UH STAG HORN FIXED BLADE

D2 STEEL SATIN FINISH BLADE

STAG HORN HANDLE

- Full Tang
- Brass Pins
- Leather Sheath

Blade Length
3" (7.62 cm)
Overall Length
7" (17.78 cm)
Weight
5.7 oz.
UPC
661120414438



7"



1085925

2204UH STAG HORN FIXED BLADE

D2 STEEL SATIN FINISH BLADE

STAG HORN HANDLE

- Full Tang
- Brass Pins
- Leather Sheath

Blade Length
4" (10.16 cm)
Overall Length
8" (20.32 cm)
Weight
6.2 oz.
UPC
661120414445



8"



MINI PRO HUNTER®

7Cr17MoV HIGH CARBON S.S. BLADE
STAGLON® HANDLE

- Full Tang
- Nickel Silver Guard
- Leather Belt Sheath

Blade Length
2.8" (7.1 cm)
 Overall Length
6.8" (17.2 cm)
 Weight
3.6 oz.



PH2N MINI PRO HUNTER® BOX
 UPC - 044356226258
PH2NCP MINI PRO HUNTER® CLAM
 UPC - 044356228646

PRO HUNTER®

7Cr17MoV HIGH CARBON S.S. BLADE
STAGLON® HANDLE

- Full Tang
- Nickel Silver Guard
- Leather Belt Sheath

Blade Length
3.6" (9.1 cm)
 Overall Length
8.1" (20.6 cm)
 Weight
6.9 oz.



PH1N PRO HUNTER® BOX
 UPC - 044356225724
PH1NCP PRO HUNTER® CLAM
 UPC - 044356226639

PRO HUNTER®

7Cr17MoV HIGH CARBON S.S. BLADE
STAGLON® HANDLE

- Brass Bolsters
- Sharpening Stone
- Leather Sheath

Blade Length
5.5" (14.0 cm)
 Overall Length
9.8" (24.9 cm)
 Weight
12.0 oz.



171UH PRO HUNTER® BOX
 UPC - 044356033206
171UHCP PRO HUNTER® CLAM
 UPC - 044356227735

BOWIE KNIFE

7Cr17MoV HIGH CARBON S.S. BLADE

STAGLON® HANDLE

- Full Tang
- Nickel Silver Bolster
- Polyester Sheath

Blade Length
10" (25.4 cm)

Overall Length
15.4" (39.0 cm)

Weight
1 lb. 0.2 oz.



15.4"



181UH UNCLE HENRY® BOWIE KNIFE BOX

UPC - 0443562220995

184STUH

BOWIE KNIFE

7Cr17MoV HIGH CARBON S.S. BLADE

STAG HORN HANDLE

- Full Tang
- Brass Guard and Pommel
- Leather Bell Sheath

Blade Length
9.7" (24.5 cm)

Overall Length
15.1" (38.5 cm)

Weight
1 lb. 3.7 oz.

UPC
044356224895



15.1"



1085922

2201UH STAG HORN GUT HOOK SKINNER

D2 STEEL SATIN FINISH BLADE

STAG HORN HANDLE

- Full Tang
- Gut Hook
- Brass Pins
- Lanyard Hole
- Leather Sheath

Blade Length
3.5" (8.89 cm)

Overall Length
7.5" (19.05 cm)

Weight
4.6 oz.

UPC
601120414414



7.5"



URCON2CP

OUTDOORSMAN COMBO PACK

7Cr17MoV HIGH CARBON S.S. BLADE STAGLON® HANDLE

- Full Tang
- Nickel Silver Guard and Pommel
- Leather Belt Sheath

301UH DETAIL SKINNER

Blade Length
3.1" (7.9 cm)
Overall Length
6.5" (16.5 cm)
Weight
2.5 oz.

182UH DROP POINT

Blade Length
3.8" (9.7 cm)
Overall Length
8.4" (21.4 cm)
Weight
6.3 oz.
UPC
044356224482

Only Available in Clam Pack



• 301UH



• 182UH

Dual Knife
Leather Belt Sheath



1085926

STAG HORN SKINNER COMBO

D2 STEEL SATIN FINISH BLADE STAG HORN HANDLE

- Full Tang
- Brass Pins
- Lanyard Hole
- Leather Sheath

UPC
661120414452

PH2N MINI PRO HUNTER®

- Nickel Silver Guard
- Leather Lanyard

Blade Length
2.8" (7.1 cm)
Overall Length
6.8" (17.2 cm)
Weight
3.6 oz.

301UH DETAIL SKINNER

Blade Length
3.1" (7.9 cm)
Overall Length
6.5" (16.5 cm)
Weight
2.5 oz.

• PH2N



• 301UH



167UH

LARGE FILLET

7Cr17MoV HIGH CARBON S.S. BLADE

STAGLON® HANDLE

- Nickel Silver Bolster
- Leather Sheath

Blade Length
7.5" (19.1 cm)
Overall Length
12" (30.5 cm)
Weight
2.9 oz.
UPC
044356003094



SMALL FILLET

7Cr17MoV HIGH CARBON S.S. BLADE

STAGLON® HANDLE

- Nickel Silver Bolster
- Leather Sheath

Blade Length
5.3" (13.4 cm)
Overall Length
10.1" (25.6 cm)
Weight
4.1 oz.



168UH SMALL FILLET BOX

UPC - 044356208604

168UHCP SMALL FILLET CLAM

UPC - 044356213974



CALDWELL™

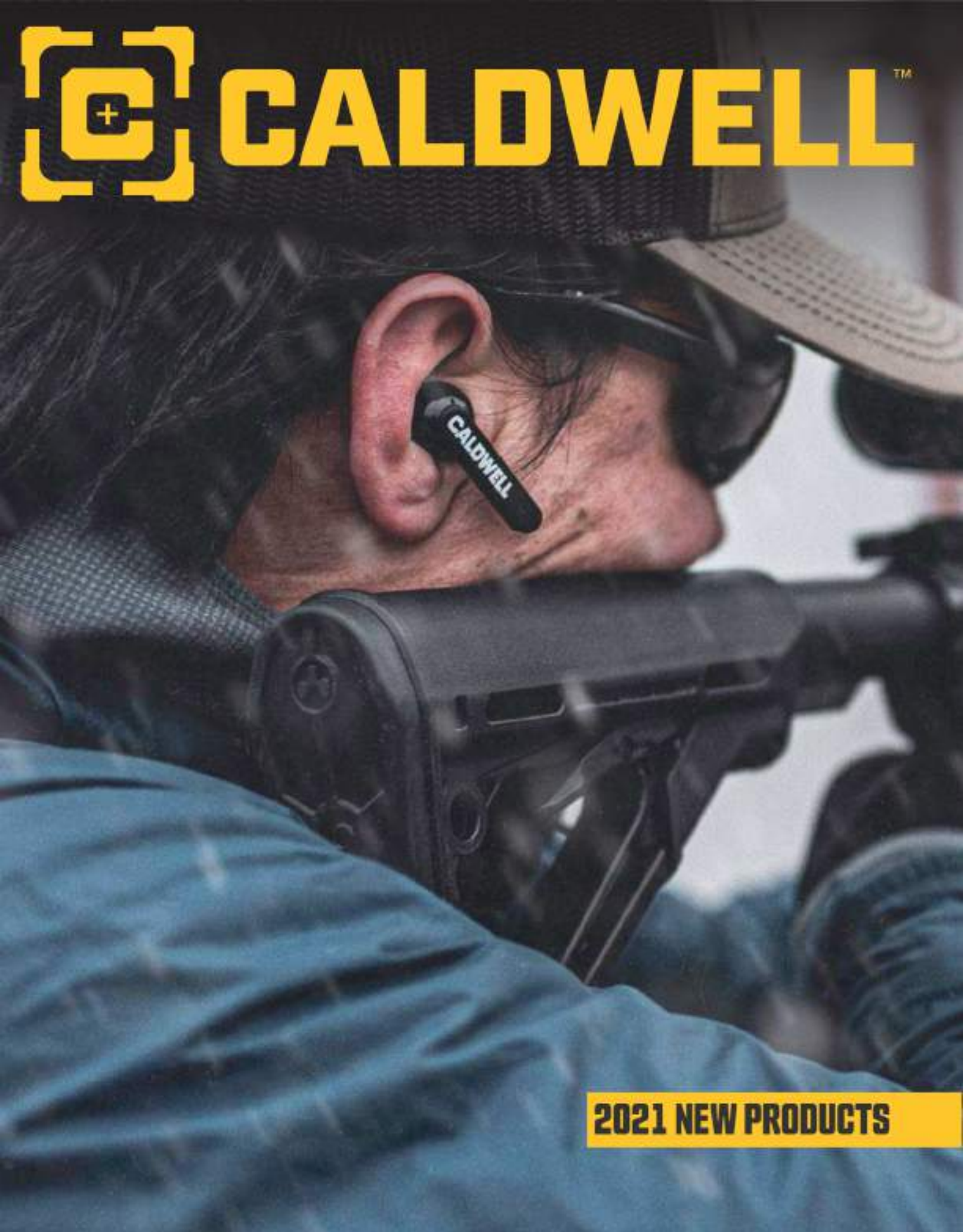

2021 NEW PRODUCTS



MAX GRIP SLIM SLINGS

Case Pack: 6

Dimensions: 13.5" H x 1.75" W x .65" D

- Over-Molded Ergonomic Design
- Quick Detach Metal Sling Swivels
- 1.5" Wide Strap Adjusts 20"-41" in Length



- A). Black.....#1131995 UPC: 661120103592
- B). Flat Dark Earth.....#1131995 UPC: 661129103691

E-MAX® PRO BT COMMS #1136235

Case Pack: 4

UPC: 661120259970

- Connects via Bluetooth
- Integrated 22 Channel UHF Radio Allows For Communication Between Multiple Users
- Ambidextrous Boom Microphone



The Bluetooth® word mark and logos are registered trademarks owned by Bluetooth SIG, Inc. and any use of such marks by Battenfeld Technologies Inc.® is under license. Other trademarks and trade names are those of their respective owners.

E-MAX® SHADOWS PRO #1136234

Case Pack: 4

UPC: 661120259961

Patents: www.aob.com/patents

- Connects via Bluetooth
- Push Button Volume Controls
- Adjustable Gain, Ambient Noise & Bluetooth
- Rechargeable Storage Case
- Multiple Size Plug Options
- LED Battery Level Indicator



E-MAX® BT LINK #1142645

Case Pack: 4

UPC: 661120260004

- Connects via Bluetooth to Hearing Protection
- Allows Communication Between Multiple Users
- Compatible with Shadows, Power Cords, Pro BT and other Bluetooth Hearing Protection



The Bluetooth® word mark and logos are registered trademarks owned by Bluetooth SIG, Inc. and any use of such marks by Battenfeld Technologies Inc.® is under license. Other trademarks and trade names are those of their respective owners.



VELOCIRADAR™ ALPHA #1121934

Case Pack: 1

UPC: 661120081364

Patents: www.aob.com/patents

- Show Series Stats (Max/Min Velocity, Avg, Velocity, SD, ES)
- Radar Activated Chronograph
- Track Bullet Velocity Down Range
- Pattern Shotguns
- Compatible with new Caldwell App
- Not Light Sensitive
- No Need to Setup Down Range
- Rechargeable Li-Ion Battery



VELOCIRADAR™ #1134904

Case Pack: 1

UPC: 661120259930

Patents: www.aob.com/patents

- Show Series Stats (Max/Min Velocity, Avg, Velocity, SD, ES)
- Radar Activated Chronograph
- Compatible with new Caldwell App
- Not Light Sensitive
- No Need to Setup Down Range
- Rechargeable Li-Ion Battery



CLAYMORE™ TARGET THROWER #1122187

Case Pack: 1

UPC: 661120081425

Patents: www.acb.com/patents

- Foot Pedal/Step Operated Cocking & Release
- Holds 50 Clay Targets
- No Battery Needed
- Throws Clay Targets over 55 Yards
- Folds for Easy Transport



PULLUP™ TARGET THROWER #1116712

Case Pack: 1

UPC: 661120079484

Patents: www.acb.com/patents

- Handheld
- Bulbup Design
- Easily Change Angles & Directions of Clay Targets
- Works with Standard 108mm and 110mm Clay Targets
- Ratcheting Charge Handle





PORTABLE RANGE KIT WITH 8" AR500 TARGET #1140016

Case Pack: 2

UPC: 661120259985

- Complete Range Ready Kit
- 8" AR500 Steel Gong Target
- Collapsible Steel Stand
- XL Strap Hanger
- Lifetime Guarantee on Target



PORTABLE TARGET STAND WITH STRAPS #1136057

Case Pack: 2

UPC: 661120259947

- Collapsible Steel Stand
- Easy to Transport
- XL Strap Hangers



XL TARGET STRAPS #1136058

Case Pack: 4

UPC: 661120259954

- Nylon Reinforced Rubber
- Withstands Multiple Bullet Impacts
- Multiple Mounting Height Options
- Includes Mounting Hardware





CALDWELL™



RETURNING PRODUCTS



LEAD SLED® 3 #820310

Patents: www.aob.com/patents

Box Size: 25.8"W x 11.3"H x 3.9"D Case Pack: 2

- Ideal for magnum rifles and slugs
- Front elevation adjustment
- Tray accommodates (2) Standard Bags filled with 25 lbs of lead shot or 1 large bag
- Non-marring skeletonized front rest and rear pad



Weight: approx. 15lbs
Dimensions: 27"L x 12"W



LEAD SLED® DFT™ 2 #336677

Patents: www.aob.com/patents

Clam Size: 30"W x 12.75"H x 5"D Case Pack: 1

- Dual Frame Technology (DFT) design disperses maximum amount of recoil energy
- Both elevation and windage adjustment
- Tray accommodates (2) Standard Bags filled with 25 lbs of lead shot or one large bag
- Up to 18" of gun fit adjustment
- Non-marring skeletonized front rest and rear pad
- Rear-height fingertip adjustment



LEAD SLED® SOLO™ #101777

Patents: www.aob.com/patents

Box Size: 24"W x 8.5"H x 6.5"D Case Pack: 2

- Elevation adjustment
- Heavy-duty steel construction
- Accommodates all rifles, including detachable magazine rifles and lever action guns
- Tray accommodates (1) Standard Bag filled with 25 lbs of lead shot
- Rubber elastic retention strap secures gun in front rest

Weight: approx. 14lbs
Dimensions: 26"L x 18"W



LEAD SLED® WEIGHT BAGS

Clam Size: 5.5"W x 9.25"H x 2"D Case Pack: 4

Standard Bag (Single).....#428334

Standard Bag (4 Bags).....#533117

Large Bag (Single).....#777800

- Made for Lead Sled® 3, Solo™, or DFT™ 2
- Small bag designed to hold 25 lbs of lead shot
- Large bag holds 20 lbs of sand
- Durable nylon-webbed handles

Standard dimensions: 5.5"W x 10"H x 3"D
Large dimensions: 10"W x 16"H x 2.5"D



CAN HOLD UP TO 25LBS OF SAND!

CAN HOLD UP TO 20LBS OF SAND!

LEAD SLED® FCX™ #820444

Patents: www.aob.com/patents

Box Size: 24.5"W x 8.75"H x 14.25"D Case Pack: 1

- Lead Sled® recoil reduction feature with Fire Control® accuracy performance
- Up to 4.5" of coarse elevation adjustment
- Up to 5.5" gun fit adjustment
- Cast aluminum weight tray accommodates approx. 75 lbs of lead shot
- Custom-fit weight bag (included, unfilled) holds approx. 50 lbs of lead shot
- Machined steel gear rack for coarse elevation adjustment

Fire Control® is an advanced alignment system that allows the shooter continual, one-hand adjustment of downrange crosshair alignment via a multi-directional control arm.
Both rests include: Medium Varmint Front Bag (pictured) and a 3-lobe bag for wider forends



Weight: approx. 22lbs
Dimensions: 35"L x 13"W

FIRE CONTROL® FRONT REST #746884

Box Size: 16"W x 13"H x 9.5"D Case Pack: 1

Patents: www.aob.com/patents

- Cast iron base for rock-solid stability



Weight: approx. 18lbs
Base dimensions: 15"L x 11.5"W

FIRE CONTROL® FULL LENGTH REST #100259

Box Size: 25.5"W x 13"H x 9.6"D Case Pack: 1

Patents: www.aob.com/patents

- Dual steel tubes connect front and rear bases
- Overmolded, non-marring rear pad



Weight: approx. 15lbs
Dimensions: 32"L x 11.5"W



ZEROMAX™ SHOOTING REST #546889

Box Size: 23.8"W x 6.5"H x 5"D Case Pack: 4

- Durable steel tube frame fabrication
- Front and rear elevation adjustment
- Front cradle designed to hold all Caldwell® Deluxe Universal Front Rest Bags
- Rock-solid shooting base for rifles and shotguns

INCLUDES

- Filled Medium Varmint Front Bag



Weight: approx. 4lbs
Dimensions: 23"L x 12"W

7 REST SHOOTING REST #1071001

Box Size: 8.5"W x 25.5"H x 2.7"D Case Pack: 4

- Ambidextrous
- Independently adjustable feet for vertical adjustment
- Front and rear cradle vertical adjustments
- Overmolded supports for extra stability
- Works great with AR-15s, rolling blocks and lever-action rifles
- Folds compact for transport and storage



Folded for transport

Weight: approx. 3lbs
Dimensions: 24"L x 12"W





HYDROSLED® #1093568

Box Size: 34.5"W x 13"H x 9"D Case Pack: 1

Patents: www.acb.com/patents

- Most advanced recoil reducing shooting rest on the market delivers up to 95% Felt Recoil Reduction
- 2.75" of horizontal gun fit adjustment to accommodate most rifles and shotguns
- Rack and pinion elevation ram for precise adjustments
- Advanced rear recoil absorbing pad protects firearm and shooter
- Easy portability when empty
- Elastic front retention strap to reduce muzzle jump



STINGER® SHOOTING REST #110033

Box Size: 32"W x 7.7"H x 7.7"D Case Pack: 2

Patents: www.acb.com/patents

- Innovative new spring-loaded elevation system
- Extremely fine elevation adjustments with fingertip control
- Up to 3" in front rest vertical adjustment
- Overmolded, non-marring front and rear cradles
- Rigid steel tube frame construction



PRECISION TURRET SHOOTING REST #821400

Box Size: 13"W x 11.5"H x 5.5"D Case Pack: 2

Patents: www.acb.com/patents

- Designed for use with AR-10/AR-15 platforms
- Forend clamp keeps rifle secure and centered
- Swivel and tilt features for maximum adjustability
- Removable, micro-adjustable pistol grip attachment
- Pistol grip rest vertical adjustment approx. 1"
- Ball bearing panning system
- Metal construction



55° panning arc using a gun with extended magazine

THE ROCK™ SHOOTING REST #383774

Box Size: 13.3"W x 4"H x 14.4"D Case Pack: 4

THE ROCK™ COMBO #383640 (The Rock™ Shooting Rest + Filled Rear Bag)

Box Size: 15.25"W x 12"H x 4.25"D Case Pack: 4

REST AND COMBO INCLUDE: Filled Medium Varmint Front Bag

- Steel ram provides smooth and quick elevation adjustments
- Forend cradle is adjustable to conform to shooting bag
- Wide 3-point iron base for extra stability
- Filled rear bag made of durable water-resistant fabric (comes with The Rock™ Combo only)



Weight: approx. 8.5lbs
Base dimensions: 13" Diameter

THE ROCK JR.™ #323225

Box Size: 10"W x 4.25"H x 9.75"D Case Pack: 4

- Up to 8" of elevation adjustment
- Sleeker, more economical design than The Rock™
- Durable 3-point base
- 3/4" diameter steel elevation post
- Interchangeable rubber feet or metal spiked feet
- Forend cradle designed to hold all Caldwell® Deluxe Universal Front Rest Bags

INCLUDES

- Filled Medium Varmint Front Bag



Weight: approx. 5.5lbs
Base dimensions: 10" Diameter

THE ROCK BR™ #440907

*Patents: www.aob.com/patents

Box Size: 16.5"W x 6.75"H x 10"D Case Pack: 1

- Up to 11.5" vertical adjustment
- Adjustable front cradle for perfect fit on any size bag or gun forend
- Forend cradle designed to hold all Caldwell® Deluxe Universal Front Rest Bags
- 3 independently adjustable metal-spiked feet
- Machined die-cast metal construction

INCLUDES

- Unfilled and filled (pictured) 3-lobe bag
- Filled Medium Varmint Front Bag



Weight: approx. 13lbs
Base dimensions: 14" Diameter

BR FOOT PADS (3-PACK) #845221

Bag Size: 4"W x 6"H x .5"D Case Pack: 6

- Rubber-coated metal washers built to hold The Rock BR™ spiked feet
- Provides non-slip base
- Non-marring on tabletop surface





MATRIX® #101600

Box Size: 16.5"W x 6.5"H x 19.5"D Case Pack: 3

*Patents: www.aob.com/patents

- One-handed elevation adjustment knob
- Up to 4.5" gun length adjustment
- Robust rigid molded supports strengthens frame
- Overmolded, non-marring front and rear cradles
- Remove rear cradle to accommodate handguns



27" L x 19" W

PISTOLERO® #562771

Box Size: 16"W x 8.4"H x 5.4"D Case Pack: 4

- Elevation adjustment
- Up to 5" length adjustment
- Up to 3" of vertical adjustment
- Overmolded, non-marring front cradle and hand rest
- Can accommodate handguns from the 1911 or S&W 500



HANDY REST NXT® #574662

Box Size: 14.3"W x 12.5"H x 4.8"D Case Pack: 4

*Patents: www.aob.com/patents

- Up to 3" vertical adjustment
- Front sling stud clearance groove
- Constructed of durable, lightweight material
- 3 non-slip foot pads for stability

INCLUDES

- Removable handgun support attachment to convert rifle rest into a handgun rest



12" Diameter

STEADY REST NXT® #548664

Box Size: 12.2"W x 10.5"H x 5.4"D Case Pack: 4

- Up to 4" elevation adjustment
- Removable bridge section for infinite gun fit adjustment
- Removable rear rest accommodates handguns
- Overmolded, non-marring front and rear cradle
- Cushioned neoprene base for handgun rest



front rest length: 11"

3-pieces assembled: 26" L x 10" W

STABLE TABLE® DELUXE SHOOTING BENCH #252552

Box Size: 36"W x 23.4"H x 8"D Case Pack: 1

*Patents: www.aob.com/patents

- Pivoting central shaft, seat and tabletop
- Weather-resistant tabletop surface 34" x 23"
- Quick-release pin adjusts padded seat from 16"–22" in height
- Welded steel construction
- Supports up to 275 lbs

INCLUDES

- (2) cleaning forks (for foreends and buttstocks)

STABLE TABLE® CARRY BAG #777610

Display Size: 13"W x 17.5"H x 3.5"D Case Pack: 1

- Full wrap-around shoulder straps
- Heavy-duty construction with double layer fabric and padded lower portion



NEW ALL-WEATHER
MOLDED SEAT



Table weight: approx. 60lbs

STABLE TABLE® LITE #1084745

Box Size: 36"W x 7"H x 23"D Case Pack: 1

*Patents: www.aob.com/patents

- Lightweight, weighs less than 30 lbs
- Fully collapsible, easy transportation and storage
- Molded carry handles in tabletop
- Ambidextrous seat pivots around rear table leg
- All-weather tabletop and seat
- Supports up to 250lbs
- Rotating table, coupled with table depth adjustment, for maximum shooting comfort



BR PIVOT® PREMIUM SHOOTING BENCH® #300015

Box Size: 47"W x 8"H x 31"D Case Pack: 1

*Patents: www.aob.com/patents

- Ambidextrous
- Stable design with fewer folding joints than other shooting benches
- Pivoting lightweight aluminum central shaft
- Hardwood maple top pivots 360° independently
- Weatherproof tabletop surface 45" x 26"
- Oversized plush seat with quick-release adjusts from 16"–27" in height
- Quick-release pin breaks down into (4) pieces for easy storage
- Welded steel construction
- Supports up to 250 lbs



*Caldwell® CUSTOM PRODUCTS are only sold via our Drop Ship Program. Please contact our sales department at 877-509-9168 for pricing and details on the program.



TACK DRIVER® SHOOTING REST (FILLED) #569230

Display Size: 11.4"W x 8.85"H x 7.5"D Case Pack: 1

TACK DRIVER® SHOOTING REST (UNFILLED) #191743

Box Size: 6.8"W x 14.8"H x 2"D Case Pack: 6

- Self-lightening surface grips the rifle and reduces felt recoil
- Non-marring, non-slip durable polyester
- Supports virtually any rifle or shotgun
- Convenient carry handle



11.4"W x 8.85"H x 7.5"D

HUNTER'S BLIND BAG #247261

Display Size: 3.75"W x 9.5"H x 1.75"D Case Pack: 6

- Ideal for deer/turkey stands, fence posts, tree limbs or truck bed sides
- Lightweight, durable polyester will not sag over time
- Narrow contour of rest matches most forends
- Tie down laces secure the bag to uneven locations



ALL FRONT AND BENCH BAGS COME FILLED!

DELUXE UNIVERSAL FRONT BAGS & BENCH SHOOTING BAGS

- A. Narrow Sporter Front Bag #108325 Case Pack: 4
- B. Medium Varmint Front Bag #263234 Case Pack: 4
- C. Wide Benchrest Front Bag #576578 Case Pack: 4
- D. Elbow Bag #774317 Case Pack: 6
- E. Universal Bag #116375 Case Pack: 6

A-C Box Sizes: 4"W x 8.25"H x 2.25"D

- Constructed from no-stretch or sag polyester and high-quality leather
- Hook & loop tabs on Front Bags allow quick installation and removal



7"L x 7"W x 1.75"H

5"L x 8"W x 2.25"H

REAR SHOOTING BAGS

- A. Standard Rear Bag (Filled) #598458
Display Size: 7.5"W x 5"H x 5.5"D Case Pack: 4
- Standard Rear Bag (Unfilled) #226645
Box Size: 3.875"W x 8.25"H x 2.5"D Case Pack: 4
- B. Medium-High Rear Bag (Filled) #800888
Display Size: 7.5"W x 5"H x 5.5"D Case Pack: 4
- C. Magnum Extended Height (Filled) #445389
Display Size: 7.5"W x 9"H x 5.5"D Case Pack: 4



A. Approx. weight 2.5lbs

B. Approx. weight 4.25lbs

C. Approx. weight 7.37lbs

DEADSHOT® SHOOTING BAGS

- A. Front Shooting Bag (Filled)** #516620
 Display Size: 8"W x 10"H x 7.5"D Case Pack: 4
- B. Rear Shooting Bag (Filled)** #640721
 Display Size: 6.3"W x 5"H x 5.5"D Case Pack: 6
- Front/Rear Combo (Filled)** #939333
 Box Size: 11.7"W x 10.5"H x 6.8"D Case Pack: 4
- Front/Rear Combo (Unfilled)** #248885
 Box Size: 5.5"W x 9.3"H x 2"D Case Pack: 4
- Made of durable, water-resistant polyester
 - Front Shooting Bag is the industry's largest (approx. 8 lbs)



5"W x 5"H x 4.5"D

16"W x 6.5"H x 6"D

TACK DRIVER® X PRECISION SHOOTING BAGS

- A. Tack Driver® X Bag** #1102665
 Display Size: 8"W x 8"H x 8"D Case Pack: 4
- B. Tack Driver® X Mini Bag** #1102666
 Display Size: 5.5"W x 5.5"H x 5.5"D Case Pack: 4
- C. Tack Driver® X Prop Bag** #1102667
 Display Size: 11"W x 8.5"H x 6"D Case Pack: 4
- The most versatile shooting bags on the market
 - Great for PRS Matches, sighting in or hunting
 - Durable construction for long service life
 - Plastic pellet filling is non-absorbent and enhances stability while shooting
 - Unique "X" shape allows for multiple shooting options
 - Three-bag lineup: Large front shooting/barricade bag, smaller shooting bag and prop bag



A.

B.

C.

AR DEADSHOT® TACTICAL BAG SET #934693

- Box Size: 13.25"W x 9"H x 5.25"D Case Pack: 4
- Stable shooting platform for all AR-15 and AR LR/10 Variant style rifles and tactical bolt-action rifles
 - Plenty of clearance for 30-round magazines
 - Heavy-duty ballistic nylon fabric
 - Pre-filled





DOWNLOAD THE FREE APP!

See the velocity of each shot on screen and record other data identifying the load and environmental conditions. The app automatically calculates average velocity, standard deviation, minimum velocity spread and maximum velocity spread for the shot string.

The Ballistic Precision Chronograph (B.P.C.) provides accurate velocity measurements across a wide range of shooting conditions. The Chrono can deliver shot string velocity data through the USB audio jack cable (included) to an iPhone®, iPad®, iPod Touch®, Android® 2.1 or newer smart phones and Kindle® Fire Tablets.

BALLISTIC PRECISION CHRONOGRAPH #720001

Box Size: 9.75"W x 21.5"H x 4.75"D Case Pack: 4

- Each unit factory calibrated within +/- 0.25% accuracy
- Ideal for firearms, archery, airgun and paintball
- Measures Meters per Second (MPS) or Feet per Second (FPS)
- Measures from 5 to 9,999 FPS
- Wide sun screens for increased readability in full sun
- Operates on a 9 Volt battery (not included)

B.P.C. LIGHT KIT #110142

Box Size: 9.75"W x 21.5"H x 4.75"D Case Pack: 4

- Ensures reliable readings in poor light conditions
- 120V AC or 4 AA battery powered (not included)
- 16 high-output LEDs in each light strip



LED Light Kit

B.P.C. PREMIUM KIT #721122

Box Size: 10"W x 17.8"H x 4.75"D Case Pack: 2

PREMIUM KIT INCLUDES

- Ballistic Precision Chronograph
- B.P.C. Light Kit
- Tripod (15"-42" height adjustment)
- 1/4"-20 dovetail mounting plate
- Y-splitter
- Rechargeable battery pack
- 15ft power cord
- Custom Kit-carry case



BALLISTIC PRECISION CHRONOGRAPH G2 #720002

Box Size: 21.75"W x 9.75"H x 6.5"D Case Pack: 2

- 19" sensor spacing for maximum accuracy
- Each unit factory calibrated to within +/- 0.25% accuracy
- Ideal for firearms, archery, airgun and paintball
- Powered by a Li-ion rechargeable battery
- 3-hour runtime with lights; 12-hour runtime without lights
- Measures Meters per Second (MPS) or Feet per Second (FPS)
- Text or email velocity, log data, notes, weather conditions
- Measures from 5 to 9,999 FPS
- Bluetooth® compatible

INCLUDES

- Tripod (up to 42" height adjustment)
- Rechargeable Li-ion battery
- 120/220v compatible charger
- Custom carry case for entire system



SMART PHONE NOT INCLUDED





DOWNLOAD THE FREE APP!

View your shots, record video, take video stills and even record/save notes without leaving the bench. The app even has a group calculation feature that tells you the grouping size!

LR TARGET CAMERA SYSTEM #156726

Box Size: 30"W x 9"H x 8.5"D Case Pack: 2

- Streams live 720p HD video up to 1 mile away
- Built-in WIFI
- System is water resistant
- Breaks down into a compact storage case for easy transport
- Integrated rechargeable Li-ion batteries for up to 10hrs of use per charge
- Features an external power jack for more permanent installation
- Compatible with Android®, iPhone®, Windows®, Kindle® and most other tablets
- Padded carry case included



220V TARGET CAMERA SYSTEM #110269

Box Size: 30"W x 9"H x 8.5"D Case Pack: 2

- CE/ROHS certified



STREAMS UP TO 1 MILE AWAY!



BALLISTIC PRECISION TARGET CAMERA SIGHT-IN #1099107

Box Size: 29"W x 9.25"H x 5.6"D Case Pack: 1

- Perfect for sighting in rifles, shotguns, handguns or bows
- Fully contained, waterproof housing for camera and transmitter
- Breaks down into a compact storage case for easy transport
- High Definition camera in 720p (App takes pictures or video clips)
- Integrated rechargeable lithium ion batteries for extended use
- Features an external power jack for more permanent installation
- Compatible with Android, iPhone and most tablets
- FREE full-featured app allows you to save pictures, add notes, calculate group size, save info and record video.





ACCUMAX® PREMIUM CARBON FIBER BIPODS

- Carbon Fiber legs are super strong and lightweight, with non-slip rubber foot
- Twist-locks for fast incremental leg length adjustment
- Legs lock forward at 90 degrees, or backward with spring-loaded buttons
- Secure leg-stops prevent legs from overextending

SWIVEL STUD ATTACHMENT

6"–9" #1092515

Box Size: 2.75"W x 9"H x 2.25"D Case Pack: 4

9"–13" #1092516

Box Size: 2.75"W x 10.25"H x 2"D Case Pack: 4

13"–30" #1095201

Box Size: 3.2"W x 13.5"H x 2.25"D Case Pack: 4

COMPATIBLE WITH M-LOK® / KEYMOD

6"–9" #1081953

Box Size: 3"W x 8"H x 2"D Case Pack: 4

9"–13" #1082223

Box Size: 3"W x 10.75"H x 2"D Case Pack: 4

13"–30" #1095203

Box Size: 3"W x 15.5"H x 2.25"D Case Pack: 4

COMPATIBLE WITH PIC RAIL

6"–9" #1081952

Box Size: 2.75"W x 7.25"H x 2"D Case Pack: 4

9"–13" #1082222

Box Size: 2.75"W x 10.25"H x 2"D Case Pack: 4

13"–30" #1095202

Box Size: 3"W x 15.5"H x 2.25"D Case Pack: 4

Weight:
6"–9" model, 8.5oz
9"–13" model, 9.1oz
13"–30" model, 13oz

Weight:
6"–9" model, 8.8oz
9"–13" model, 9.2oz
13"–30" model, 13oz

Weight:
6"–9" model, 8.8oz
9"–13" model, 9.3oz
13"–30" model, 13oz



Swivel Stud



M-LOK®/Keymod



Pic Rail

XLA BIPOD®

COMPATIBLE WITH M-LOK® / KEYMOD

6"–9" #1081950

Box Size: 3.25"W x 8.75"H x 2.3"D Case Pack: 6

9"–13" #1081951

Box Size: 3.25"W x 10.75"H x 2.3"D Case Pack: 6

- Lowest profile bipod mount available
- M-LOK® and KeyMod adapter for use on polymer hand guards
- Lightweight and sturdy aluminum construction
- Quick-deployment legs extend to shooting position with the touch of a button
- Legs are notched for easy indexing to a specific height
- Twist-lock technology for locking legs between notches
- Soft rubber feet provide enhanced stability



Weight:
6"–9" model, 8oz
9"–13" model, 9oz

COMPATIBLE WITH PIC RAIL

6"–9" #110140

Box Size: 3.2"W x 8.2"H x 2.2"D Case Pack: 6

9"–13" #110141

Box Size: 3.2"W x 10.2"H x 2.2"D Case Pack: 6

- Lightweight aluminum design
- Adjustable leg height for the perfect positioning
- Soft rubber feet for enhanced stability
- Collapsible for transport

1.5" long Pic Rail

Quick-release cam lever lock

Leg locking knob

Weight:
6"–9" model, 8oz
9"–13" model, 9oz

XLA BIPOD®

6"–9" (Black)..... Fixed..... #379852..... 9oz

6"–9" (Black)..... Pivot..... #247142..... 12oz

6"–9" Box Size: 3"W x 8.2"H x 2.2"D Case Pack: 6

9"–13" (Black)..... Fixed..... #403215..... 11oz

9"–13" (Black)..... Pivot..... #571429..... 13oz

9"–13" (Camo)..... Pivot..... #445033..... 13oz

9"–13" Box Size: 3"W x 10.2"H x 2.2"D Case Pack: 6

13"–23" (Black)..... Fixed..... #591336..... 14oz

13"–23" (Black)..... Pivot..... #701417..... 16oz

13"–23" Box Size: 3"W x 16.5"H x 2.2"D Case Pack: 6

13.5"–27" (Black)..... Pivot..... #635705..... 19oz

13.5"–27" (Camo)..... Pivot..... #445088..... 19oz

13.5"–27" Box Size: 3"W x 16.5"H x 2.2"D Case Pack: 6

- Legs instantly spring-out with the touch of a button
- Legs collapse forward for transport
- Non-slip rubber feet for enhanced stability
- Padded base protects firearm forend

LOWEST PROFILE
ALUMINUM
DESIGN



Pivot models allow up to 18° directional cam left or right



PIC RAIL ADAPTER PLATE #156716

Clam Size: 3.75"W x 8.3"H x 1.25"D Case Pack: 6

- Simultaneously utilizes shoulder sling and a pic rail mounted accessory
- Adjustable tension and vertical angle



BIPOD ADAPTER FOR PICATINNY RAIL #535423

Clam Size: 3.75"W x 7.25"H x 1.5"D Case Pack: 6

- Attach any traditional bipod or sling to a Picatinny rail
- Lightweight, durable machined aluminum construction
- (2) integrated fasteners for secure attachment



BIPOD PIVOT LOCK #535881

Clam Size: 3.25"W x 5.5"H x 1"D Case Pack: 5

- Works on all Caldwell® XLA® Bipod Pivot models
- Spring loaded "pull-out" for easy handle positioning
- Second adapter for SAE #10-32 threaded external spring bipods



AR BIPODS

● Prone Model, 7.5"-10" (Black) #531123

● Prone Model, 7.5"-10" (Desert Tan) #534455

Clam Size: 3"W x 10"H x 2.5"D Case Pack: 4

● Sitting Model, 14.5"-30.5" (Black) #532255

Clam Size: 3"W x 18"H x 2.5"D Case Pack: 4

- Quickly attaches/detaches to any pic rail
- Lightweight and durable anodized aluminum construction
- Non-slip rubber feet for enhanced stability



SHOOTING BIPOD

Prone Model, 8.75"-12" #457855 *18.5oz*

Clam Size: 3"W x 13.2"H x 2.5"D Case Pack: 4

Sitting Model, 14"-30" #335235 *15oz*

Clam Size: 3"W x 19.2"H x 2.5"D Case Pack: 4

- Easily attachable and detachable from the front swivel stud
- Lightweight aluminum design for quiet, weatherproof performance
- Built-in swivel pan feature left or right 20° combined with an 18° bi-directional cant
- Stud for sling attachment





MAG SHIELD #300010

Clam Size: 8.9"W x 11.6"H x 1.5"D Case Pack: 6

Weight: 4oz

- Soft leather front and back provides ample friction to keep gun locked into the shield and the shield locked into the shoulder
- Ambidextrous
- 1/2" thick, energy-absorbing pad
- Approx. 20 cubic inches of coverage



MAG SHIELD PLUS #310010

Clam Size: 8.9"W x 11.6"H x 1.5"D Case Pack: 6

Weight: 6oz

- Soft leather front and back provides ample friction to keep gun locked into the shield and the shield locked into the shoulder
- Ambidextrous
- 1/2" thick, heart shaped, energy-absorbing pad
- Approx. 32 cubic inches of coverage



SUPER MAG SHIELD PLUS #330110

Clam Size: 8.9"W x 11.6"H x 1.5"D Case Pack: 6

Weight: 10oz

- Soft leather front and back provides ample friction to keep gun locked into the shield and the shield locked into the shoulder
- Highest protection level of any PAST Shield
- Ambidextrous
- 1" thick, heart shaped, energy-absorbing pad
- Approx. 40 cubic inches of coverage



FIELD SHIELD #350010

Clam Size: 8.9"W x 11.6"H x 1.5"D Case Pack: 6

Weight: 4oz

- Soft leather front and back provides ample friction to keep gun locked into the shield and the shield locked into the shoulder
- Perfect choice for shotgun use or use in the field
- Ambidextrous
- 1/4" thick, energy-absorbing pad
- Approx. 37 cubic inches of coverage



HIDDEN COMFORT RECOIL SHIELD #360000

Clam Size: 8.9"W x 11.6"H x 1.5"D Case Pack: 6

Weight: 2oz



- Comfortable cotton-blend cover easily attaches to bra strap without removing the blouse or shirt
- Secures with hook and loop closure system
- Ambidextrous
- 1/4" thick, energy-absorbing pad
- Approx. 30 cubic inches of coverage



E-MAX® SHADOWS #1102673

Case Pack: 4

- Bluetooth compatible with mobile devices
- 25dB NRR
- High quality stereo sound
- Separate left and right channel earplugs
- Rechargeable storage case
- Dual microphones for directional clarity
- Illuminated on/off Indicator
- Auto-shutoff (4 hours without touching controls)
- Multiple size tips for custom fit



E-MAX® POWER CORDS #1121933

Case Pack: 4

- Bluetooth compatible with mobile devices
- 22dB NRR
- High quality stereo sound
- Rechargeable Lithium-Ion Battery
- Corded design keeps earplugs together
- Illuminated on/off indicator
- Auto-shutoff (4 hours without touching controls)
- Multiple size tips for custom fit



Interchangeable Foam & Silicone Tips



"The Bluetooth® word mark and logos are registered trademarks owned by Bluetooth SIG, Inc. and any use of such marks by Ballanfeld Technologies Inc.® is under license. Other trademarks and trade names are those of their respective owners."

E-MAX® PRO BT #1099596

Case Pack: 4

- Bluetooth® compatible with mobile devices
- 24dB NRR
- Low-profile design for uninterrupted cheek weld
- High quality stereo sound
- Easy to use push button volume controls
- Illuminated on/off indicator
- Auto-shutoff (4 hours without touching controls)
- Runs on Caldwell's Rechargeable Lithium-Ion Battery Pack (included) or 3 AAA batteries
- Compact folding design



"The Bluetooth® word mark and logos are registered trademarks owned by Bluetooth SIG, Inc. and any use of such marks by Ballefeld Technologies Inc.® is under license. Other trademarks and trade names are those of their respective owners."

E-MAX® PRO

- 23dB NRR
- Low-profile design for uninterrupted cheek weld
- High quality stereo sound
- Easy to use push button volume controls
- Illuminated on/off indicator
- Auto-shutoff (4 hours without touching controls)
- Runs on 3 AAA Batteries (included)
- Compatible with Caldwell's Rechargeable Lithium-Ion Battery Pack (sold separately)
- Available in youth sizes and colors



A. Gray#1099602	Case Pack: 4
B. Flat Dark Earth#1099603	Case Pack: 4
C. Aqua#1101672	Case Pack: 4
D. Youth Neon Blue#1103307	Case Pack: 4
E. Youth Hot Coral#1108763	Case Pack: 4
F. Youth Neon Green#1103306	Case Pack: 4
G. Lithium-Ion Battery#1108859	Case Pack: 6





PASSIVE HEARING PROTECTION

Case Pack: 4

- Low-profile design for uninterrupted cheek weld
- 24dB NRR
- Comfort padded headband
- Soft comfortable ear cushions
- Compact folding design
- Available in youth sizes and colors



A. Adult Gray.....	#1103305	Case Pack: 4
B. Youth Hot Coral.....	#1108764	Case Pack: 4
C. Youth Neon Blue.....	#1103308	Case Pack: 4
D. Youth Neon Green.....	#1103309	Case Pack: 4



E-MAX[®] LOW PROFILE

Box Size: 7.2"W x 9.5"H x 4.2"D Case Pack: 6

- 23 NRR
- Dual microphones
- LED 'ON' indicator
- Padded, adjustable headband
- Cushioned foam ear cups
- Uses 2 AAA batteries (not included)

A. Green.....	#487557
B. Pink.....	#487111
C. Mossy Oak Break-Up.....	#487200



E-MAX® #497700

Box Size: 7.2"W x 9.5"H x 4.2"D

Case Pack: 6

- 25 NRR
- Dual microphones
- LED 'ON' indicator
- Padded, adjustable headband
- Cushioned foam ear cups
- Uses 2 AAA batteries (not included)



E-MAX® BTH #487605

Clam Size: 9.25"W x 11"H x 5.5"D

Case Pack: 6

- 20 NRR
- Dual microphones
- LED 'ON' indicator
- Padded, adjustable headband
- Cushioned foam ear cups
- Uses 2 AAA batteries (not included)



RANGE PLUGS (10-PACK) #568231

Clam Size: 2.5"W x 4.25"H x 2.5"D Case Pack: 12

- 33 NRR Rating
- Tapered design makes the plugs easy to insert
- Polyurethane foam makes plugs comfortable to wear
- Clips to shirts or hats





COMBO PACKAGE #467309

Clam Size: 7.4"W x 7.9"H x 4"D Case Pack: 6

- Meets ANSI Z87.1 standards
- Adjustable nose piece and temples
- Blocks 99.9% of harmful UV rays
- Impact resistant

INCLUDES

- E-Max® Low Profile Electronic Hearing Protection
- Caldwell® Pro Range Shooting Glasses



PRO RANGE SHOOTING GLASSES #320040

Clam Size: 3.75"W x 9.25"H x 3"D Case Pack: 10

- Adjustable nose piece and temples
- Blocks 99.9% of harmful UV rays
- Impact resistant lenses
- Meets ANSI Z87.1 standards



EYES & EARS BELT CLIP #417600

Clam Size: 3"W x 6.75"H x 1"D Case Pack: 6

- Fits up to a 2 1/4" wide belt
- Constructed of flexible polymer
- Hang muffs and eye protection from same hook



ULTIMATE SHOOTING GLOVES

Small/Medium #1071004

Large/XL #1071005

Display Size: 5"W x 10"H x 1.5"D Case Pack: 6

- Padded palms reduces felt recoil
- Lightweight, durable material
- Elastic backing and fingers provides a custom grip for extreme dexterity
- Leather reinforcement patch protects against "slide bite"
- Touch-sensitive finger tips allow full use of smart phones



UNIVERSAL BRASS CATCHER S.A. #110038

Box Size: 6.7"W x 8"H x 3.9"D Case Pack: 4

*Patents: www.acb.com/patents

- Swing-open design allows for convenient chamber access
- Universal double hook & loop attachment for use on bolt-action and semi-automatic rifles
- Internal cage design maintains bag shape
- Heat-resistant mesh bag
- Zippered bottom for easy brass removal
- 100 round capacity (.223 cal)



Double hook & loop attachment

BRASS TRAP #122560

Box Size: 6.75"W x 19.75"H x 2"D Case Pack: 4

- Use on benchtop or mount to any tripod with a 1/4-20 male threaded stud (tripod not included)
- Bottom of mesh bag unzips for easy empty
- Heat-resistant mesh
- Collapses into storage bag (included)



Brass Trap collapses small enough to fit in most range bags

A. PIC RAIL BRASS CATCHER #530143

Clam Size: 7"W x 9.85"H x 4"D Case Pack: 4

- Mounts to any Picatinny rail handguard
- Also compatible with most AR-10/LR-308 models
- Internal wire frame maintains bag shape
- Heat-resistant mesh bag
- 100 round capacity (.223 cal)



B. PIC RAIL SPARE MOUNT #123904

Clam Size: 3.3"W x 5.25"H x 1"D Case Pack: 4

AR-15 BRASS CATCHER #122231

Clam Size: 6"W x 10.125"H x 1.875"D Case Pack: 4

- Adjustable hook & loop closure attaches to most any AR-15
- Adjustable wire frame forms to most forends
- Bottom of mesh bag unzips for easy empty
- Internal wire frame maintains bag shape
- Heat-resistant mesh bag
- 30 round capacity (.223 cal)



AK MAG CHARGER® AMMO BOX—7.62X39 (5-PACK) #397480

Clam Size: 7.5"W x 12.75"H x 3.75"D Case Pack: 6

AR-15 MAG CHARGER® AMMO BOX—.223/.204 (5-PACK) #397623

Clam Size: 6.3"W x 12"H x 3.3 Case Pack: 6

- AK Mag Charger® holds 50 rounds of 7.62x39 per box
- AR-15 Mag Charger® holds 50 rounds of .223, 5.56x45, .204 and 300 AAC Blackout per box





MAG CHARGER® AR-15 #397488

Clam Size: 11.25"W x 12.5"H x 4.75"D Case Pack: 4

Patents: www.aob.com/patents

- Accepts 50 rounds of .223, 5.56, .204 or 300 AAC Blackout loaded ammo
- Transfers ammo directly from AR-15 Mag Charger® Ammo Box
- Loads 5 rounds per "stroke" with auto advance
- Compatible with all AR platform mags

COMPATIBLE WITH:



MAG CHARGER® TAC 30 #397493

Clam Size: 12"W x 11.6"H x 4.85"D Case Pack: 4

Patents: www.aob.com/patents

- Accepts 30 rounds of .223/5.56 NATO, or .204 Ruger®
- Accepts up to 3, 10-round stripper clips
- Transfers ammo directly from a 20 round box, a stripper clip or using the included Stripper Rail
- Loads 10 rounds per "stroke"
- Compatible with all AR platform mags

COMPATIBLE WITH:



MAG CHARGER® UNIVERSAL PISTOL LOADER #110002

Clam Size: 7"W x 9"H x 2"D Case Pack: 4

Patents: www.aob.com/patents

- Universal magazine design compatible with both single-stack and double-stack magazines
- Accepts 9mm, 10mm, .357 Sig, .40 S&W and .45 cal

Double stack extended, large single stack, large double stack, small double stack, small single stack and compact

COMPATIBLE WITH:



22LR ROTARY MAG CHARGER® #1099117

Box Size: 5"W x 12"H x 4"D Case Pack: 4

Patents: www.aob.com/patents

- Fastest T/CR22® and 10/22® magazine loader on the market
- Holds up to 100 rounds 22LR ammo in the hopper
- Rotary mag unload notch quickly strips ammo from a magazine
- Hopper automatically orients ammo correctly



22LR 15-22 MAG CHARGER® #1097887

Box Size: 5"W x 13"H x 3.25"D Case Pack: 4

Patents: www.aob.com/patents

- Fastest AR-15 22LR magazine loader on the market
- Compatible with the M&P® 15-22 magazine
- Ammo hopper automatically orients rounds for loading
- Hopper holds over 100 rounds of 22LR ammo
- Easy hand held operation



FAST CASE GUN COVER #110039

Display Size: 7"W x 10"H x 3.5"D Case Pack: 6

- Durable fabric withstands abrasions and tough use
- Water resistant PVC-lined fabric
- Fits rifles or shotguns from 40"-54" in length
- Folds up compact for storage



AR MODULAR DUAL POINT SLING KIT #156216

Clam Size: 5.5"W x 9.5"H x 4.4"D Case Pack: 4

- Use as a single-point sling or detach second spring-loaded carabiner and set up as a standard dual-point sling
- AR Receiver End Plate included
 - Ambidextrous
 - Solid steel plate
 - Made in the U.S.A.



AR RECEIVER END PLATE ONLY #390501

Clam Size: 3.5"W x 5.5"H x 1.5"D Case Pack: 6

ITAR controlled

SINGLE POINT TACTICAL SLING KITS #156215

Clam Size: 4.75"W x 13.75"H x 3"D Case Pack: 4

- AR Receiver End Plate included
 - Ambidextrous
 - Solid steel plate
 - Made in the U.S.A.



AR-15 MAG COUPLER (2-PACK) #390504

Clam Size: 4.3"W x 7.3"H x 1.4"D Case Pack: 6

- Easily couples 2 Mil-spec style 10-round AR-15 magazines with no additional weight
- Holds magazines end-to-end to maintain shape of 30-round mag

INCLUDES

- (2) couplers to couple a total of 4 magazines
- (2) dust covers to keep dust out and protect bullet tips





MAX GRIP SLINGS

● **Black** #156219

● **Flat Dark Earth** #156214

Display Size: 5.75"W x 18.5"H x 1"D Case Pack: 6

- Ergonomic overmolded design
- Max Grip ensures secure and comfortable gun carry
- Includes quick-detach metal sling swivels
- 20"-41" adjustable length
- 2.75" strap to distribute weight of the firearm

METAL SLING SWIVELS INCLUDED WITH ALL SLINGS



WIND WIZARD II™ #102579

Clam Size: 7.5"W x 8"H x 1.5"D Case Pack: 4

- Measures wind speed in mph, ft/min, km/h, m/s or knots
- Temperature display in Celsius and Fahrenheit
- Non-slip protective rubber sleeve
- Windchill display
- LCD backlight
- Auto OFF

INCLUDES

- Carry holster
- (1) CR2032 battery



CLAY LAUNCHERS

Single Thrower #505501

Clam Size: 6.5"W x 19.5"H x 1"D Case Pack: 6

Double Thrower #505502

Clam Size: 10.5"W x 31"H x 2"D Case Pack: 6

- Portable and affordable hand held clay target launcher
- Works with all standard size clay targets (108-110mm)
- Launches right or left handed



Double thrower features 2 single throwers mounted to an adapter handle

BRASS RETRIEVER #125789

Box Size: 22"W x 8"H x 5.8"D Case Pack: 4

- Works on virtually any ground surface (i.e. grass, gravel, concrete)
- Telescoping handle expands from 28"-57" tall



AR500 STEEL

- 3/8" through hardened AR500 steel can withstand thousands of rounds
- Rated up to 3,000 fps impact velocity
- Rated up to 3,500 ft lbs impact energy
- 7 Sizes with 3 hanging solutions
- Full display options for retailers

AR500 5" Caldwell C #1116700

Dimensions: 6.25"L x 5.5"W x .4"D Case Pack: 6

AR500 8" Caldwell C #1116703

Dimensions: 9.1"L x 8"W x .4"D Case Pack: 6

AR500 10" Coffin #1116693

Dimensions: 13"L x 8"W x .4"D Case Pack: 4

AR500 13" Octagon #1116695

Dimensions: 13"L x 13"W x .4"D Case Pack: 3

AR500 33% IPSC #1116697

Dimensions: 10"L x 6.1"W x .4"D Case Pack: 8

AR500 66% IPSC #1116702

Dimensions: 20"L x 12"W x .4"D Case Pack: 2

AR500 Full Size IPSC #1116705

Dimensions: 30"L x 18.25"W x .4"D Case Pack: 1



AR-500 STEEL HANGERS

A. T-Post Plate Hanger #1102669

Dimensions: 5"L x 2.2"W x 2.25"D Case Pack: 6

B. 2x4 Plate Hanger #1102670

Dimensions: 6.75"L x 7"W x 2.5"D Case Pack: 6

C. Strap Plate Hanger Set #1102671

Dimensions: 12.5"L x 4"W x 2.25"D Case Pack: 6

A.



B.



C.





RESETTING METAL TARGETS

Handgun Target #1071002

Clam Size: 12"W x 29.5"H x 1.8"D Case Pack: 2

.22 Rimfire Target #902365

Clam Size: 16.8"W x 22.5"H x 1.8"D Case Pack: 4

Airgun Target #820585

Clam Size: 11.5"W x 15"H x 1"D Case Pack: 4

- Made for up to 45 ACP, 44 Special
- 1/2" thick steel rod frames
- 3/8" thick steel metal shooting plates

Airgun Target

Target size: 1.5"



Handgun Target

Target size: 3.5"



.22 Rimfire Target

Target size: 2.5"



PLINK N' SWING ACTION TARGETS

Centerfire Handgun Double Spin #133565

Box Size: 26.8"W x 12"H x 1.8"D Case Pack: 4

.22 Rimfire Triple Spin #147072

Box Size: 18.6"W x 13"H x 2.8"D Case Pack: 4

- Made for up to 45 ACP, 44 Special
- 1/2" thick steel rod frames
- 3/4" thick steel metal shooting plates

ADJUSTABLE
& VISUAL
FEEDBACK

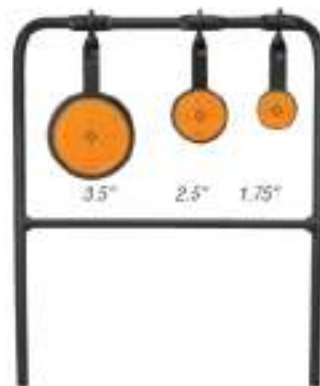

MAGNUM RIFLE GONG® #223375

Box Size: 36"W x 4"H x 12"D Case Pack: 2

- Gong hangs 18" above the ground
- Overall size 38"W x 33"H
- Gong is 3/8" thick

(GONG ONLY) #178951

Box Size: 10.3"W x 9.3"H x 1"D Case Pack: 1



MAGNUM TARGET CARRY BAG #894050

Box Size: 18.5"W x 16.4"H x 1.75"D Case Pack: 2

- Made for Magnum Rifle Gong®



AR-500 SWINGER TARGET #758995

Box Size: 20"W x 4.5"H x 4.5"D Case Pack: 2

- 3/8" through-hardened AR-500 Steel
- Extremely durable cast urethane frame connectors provide a rigid frame yet allow bullets to pass right through
- Solid steel legs and crossbar provide a rigid frame
- Legs replaceable by 1/2" re-bar, if damaged
- 18" Tall
- Highly portable for ease of use



ULTIMATE TARGET STAND #707055

Display Size: 10.5"W x 24"H x 2"D Case Pack: 4

*Patents: www.aob.com/patents

- Modular frame design collapses for transport
- All-weather backer resistant to moisture and rotting
- Frame arms constructed of durable steel rod
- Frame stand made of robust thick plastic
- Removable center stabilizing rod



Backer board easily holds (2) 10"x10" targets (targets sold separately)

REPLACEMENT BACKER (2-PACK) #707100

Display Size: 10.5"W x 17.6"H x 1"D Case Pack: 6

ULTRA PORTABLE TARGET STAND KIT #110005

Box Size: 12"W x 18"H x 2"D Case Pack: 6

- Ultra-portable design
- Extra large backer can hold 12"W x 18"H targets
- Great for sighting in or patterning
- Collapses for easy transport

INCLUDES

- Rod stand
- (8) Silhouette targets
- Backer
- (8) High-contrast targets
- Clamps



TARGET TURNER #1096103 *Patents: www.aob.com/patents

Box Size: 21"W x 7.3"H x 9.25"D Case Pack: 2

- Presents and hides target for interactive shooting and training
- Adjustable speed presents target from 1 - 6 second delay
- Includes reusable target backer for targets up to 12" x 18"
- Accepts all IDPA, IPSC and NRA Action Pistol Cardboard Targets
- Powered by 8 AA batteries
- Average battery life is 11 hours
- Quickly collapses into included carry bag for transportation
- Comes with storage bag for easy transport





- Adhesive-backed, sticks to any surface
- Inside black target flakes off neon yellow
- Outside orange target and direct bullseye hit flakes off white

ORANGE PEEL® BULLSEYE SHOOTING TARGETS

*Patents: www.aob.com/patents

2" Bullseye Target, 10 sheets	#686444	Case Pack: 10
3" Bullseye Target, 15 sheets	#391984	Case Pack: 10
4" Bullseye Target, 5 sheets	#405515	Case Pack: 10
4" Bullseye Target, 10 sheets	#410864	Case Pack: 10
4" Bullseye Target, 25 sheets	#425824	Case Pack: 5
5.5" Bullseye Target, 10 sheets	#550010	Case Pack: 10
5.5" Bullseye Target, 50 sheets	#555050	Case Pack: 5
8" Bullseye Target, 5 sheets	#805645	Case Pack: 10
8" Bullseye Target, 10 sheets	#810894	Case Pack: 10
8" Bullseye Target, 25 sheets	#825915	Case Pack: 5
8" Bullseye Target, 100 sheets	#810099	Case Pack: 1
12" PINK Bullseye Target, 5 sheets	#317536	Case Pack: 5
12" Bullseye Target, 5 sheets	#120556	Case Pack: 5
12" Bullseye Target, 10 sheets	#121066	Case Pack: 5
12" Bullseye Target, 50 sheets	#125004	Case Pack: 1
12" Bullseye Target, 100 sheets	#121005	Case Pack: 1
16" Bullseye Target, 5 sheets	#172505	Case Pack: 5
16" Bullseye Target, 10 sheets	#172510	Case Pack: 5



Orange Shooting Spots included with all targets

ORANGE PEEL® SIGHT-IN SHOOTING TARGETS

*Patents: www.aob.com/patents

8" Sight-In Target, 5 sheets	#522357	Case Pack: 5
12" Sight-In Target, 5 sheets	#244561	Case Pack: 5
12" Sight-In Target, 100 sheets	#861579	Case Pack: 1
16" Sight-In Target, 5 sheets	#495253	Case Pack: 5
16" Sight-In Target, 12 sheets	#492603	Case Pack: 5



ORANGE PEEL® OVAL SHOOTING TARGETS

*Patents: www.aob.com/patents

12" x 18" Sight-In Target, 5 sheets	#488789	Case Pack: 10
12" x 18" Sight-In Target, 100 sheets	#123665	Case Pack: 1

ORANGE PEEL® ANIMAL SHOOTING TARGETS

12" Turkey Target, 5 sheets	#586485	Case Pack: 5
-----------------------------	---------	--------------



SHOOTING SPOTS AND SQUARES

1" Shooting Spots, 12 sheets/216ct	#754883	Case Pack: 10
1.5" Shooting Spots, 12 sheets/96ct	#652710	Case Pack: 10
2" + 1" Shooting Spots, 12 sheets/108ct	#754110	Case Pack: 10
3" Shooting Spots, 12 sheets/24ct	#271050	Case Pack: 10
1" Shooting Squares, 12 sheets/216ct	#711236	Case Pack: 10



HIGH CONTRAST PAPER TARGETS

16" Blue 9 Diamond Target (10-pack).....#966893

16" Blue Sight-In Target (10-pack).....#198604

16" Black & Orange Target (10-pack).....#195781

Pack Size: 17.2"W x 17.2"H x .25"D Case Pack: 10

- Large 16" x 16" sheets
- High visibility color to see at long ranges
- Diamond shaped targets for easy crosshair alignment
- 1" grid for simple scope adjustments

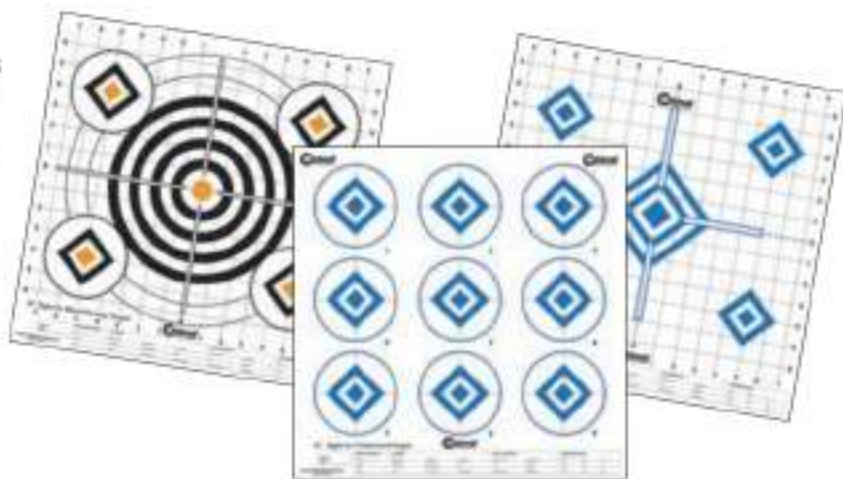

SILHOUETTE FLAKE OFF TARGETS

DualZone Flake Off Target (8-pack).....#308214

CENTER MASS Flake Off Target (8-pack).....#412803

Size: 12"W x 18"H x .25"D Case Pack: 10

DualZone Flake Off Target (25-pack).....#280341

CENTER MASS Flake Off Target (25-pack).....#128034

Size: 12"W x 18"H x 1"D Case Pack: 5

- Ideal for defensive shooting skill development
- 12" x 18" heavy card stock paper
- 2:1 size ratio (target at 5 yards represents 6' tall target at 10 yards)



DURAMAX™ SELF-HEALING TARGETS

5" Square #897597

5" Ball #897602

Display Size: 5"W x 10"H x 5"D Case Pack: 6

- Made of ballistic polymer for maximum durability
- Targets are self-healing for repeated use
- Rated for pistols or rifles from .22LR up to .50 BMG
- Reactive targets bounce, roll, spin or flip when hit





FRANKFORD ARSENAL™



2021 NEW PRODUCTS

FRANKFORD ARSENAL®

FX-10™ PROGRESSIVE PRESS #1135898

Case Pack: 1

UPC: 661120263586

Patents: www.acb.com/patents

- 10 Station Press
- Optional Case & Bullet Feeder
- Case Activated Powder Measure
- Integrated Bearings for Smooth Operation
- In Line Primer Pocket Swaging
- Spring Loaded Case Locator Buttons
- Load Cartridges up to .30-06 Length
- Shell Plates for Popular Calibers (not included)
- 9mm / .38 Super
- .40 S&W / 10MM
- .45 ACP / .308
- .223
- .45 LC
- .38Spl / .357 Mag.





FX-10™ SHELL PLATES

Case Pack: 1

Patents: www.acb.com/patents

- 6 Sizes Available to Fit Most Popular Calibers
- Laser Marked for Easy ID
- Integrated Bearing for Smooth Operation

9mm / 38 Super.....	#1136230	UPC: 661120260080
40 S&W / 10MM.....	#1135905	UPC: 661120260059
45 ACP / .308.....	#1135902	UPC: 661120260028
.223 / .300 AAC.....	#1135903	UPC: 661120260035
45 LC.....	#1135904	UPC: 661120260042
38 Spl / .357 Mag.....	#1135901	UPC: 661120260011



FX-10™ TOOL HEAD #1136231

Case Pack: 1

UPC: 661120260097

- Compatible with FX-10™ Progressive Press
- Steel Construction
- Integrated LED Light
- Standard 7/8"-14 Dies



FRANKFORD ARSENAL®

FX CASE FEEDER #1135899

Case Pack: 1

UPC: 661120263379

*Patents: www.aob.com/patents

- Feeds 9mm – .308
- Handgun & Rifle Case Plates Included
- Sound Reducing Lid
- Automatic On/Off
- 110V



FX BULLET FEEDER #1135900

Case Pack: 1

UPC: 661120263548

*Patents: www.aob.com/patents

- Compatible with FX-10™ Progressive Press
- Feeds Handgun 9mm, .40, .45
- Feeds Rifle .223 to .308
- Sound Reducing Lid
- Automatic On/Off
- 110V

NO IMAGE



CASE ACTIVATED POWDER MEASURE #1135232

Case Pack: 1

UPC: 661120260103

Patents: www.aab.com/patents

- Compatible With Frankford FX-10™ Progressive Press
- Includes Measure & Required Linkage For Operation
- Static Free Aluminum Body
- Unique Hopper Shape Prevents Powder Bridging
- Micrometer Adjustable Powder Dispensing
- Powder Drum Rides in Ball Bearings for Smooth Operation



POWDER MEASURE #1136233

Case Pack: 1

UPC: 661120260110

Patents: www.aab.com/patents

- Static Free Aluminum Body
- Compatible with .22 - .50 Cal
- No Binding or Bridging of Powder
- Micro Adjustable Dispensing
- Handgun Powder Drum Available
- Bench Top Stand
- Powder Drum Rides in Ball Bearings for Smooth Operation



RENDER

RENDER

FRANKFORD ARSENAL

INTELLICHARGER™ AUTOMATED POWDER DISPENSER #1136020

Case Pack: 1

UPC: 661120260066

*Patents: www.aob.com/patents

- Automated Powder Weighing and Dispensing
- 50 Case Capacity
- +/- 0.1gn Accuracy
- Patented Powder Calibration Technology
- Easy Powder Removal/Change
- Full Feature App for Custom Load Parameters
- Load up to .338 Lapua Length Cartridges
- Load up to .45 Cal Cases



PERFECT FIT GEN 2 RELOADING TRAYS

Case Pack: 1

- Compatible with Intellicharger Powder Dispenser
- Multiple Sizes for Perfect No Tilt Fit
- 2 Pack

9mm / 223.....	#1148646	UPC: 661120260141
7.62x39.....	#1148647	UPC: 661120260138
.45 ACP / .308.....	#1148648	UPC: 661120260165
.45 LC/ 30-30.....	#1148649	UPC: 661120260172
Magnum Rifle.....	#1148650	UPC: 661120260189
.45-70.....	#1148651	UPC: 661120260196

NO IMAGE



F-1[®] SINGLE STAGE RELOADING PRESS #1122194

Case Pack: 2

UPC: 661120081449

Patents: www.aob.com/patents

- Ram Rides in Ball Bearings for Smooth Operation
- Loads up to 338 Lapua Length Cartridges
- Integrated LED Light
- Compatible w/ Standard 7/8"-14 Dies
- Uses Standard Shell Holders
- No-Mess Primer Catch uses Bottle or Hose Barb
- Solid Steel Rod Frame Pillars

ALUMINUM POWDER FUNNEL KIT #1136021

Case Pack: 4

UPC: 661120260073

- Static Free Aluminum Construction
- 8 Interchangeable Nozzles Fit .17-35+ Cal.
- Laser Marked for Easy Caliber ID
- Smooth Black Chrome Finish
- Storage Case Included





FRANKFORD ARSENAL™

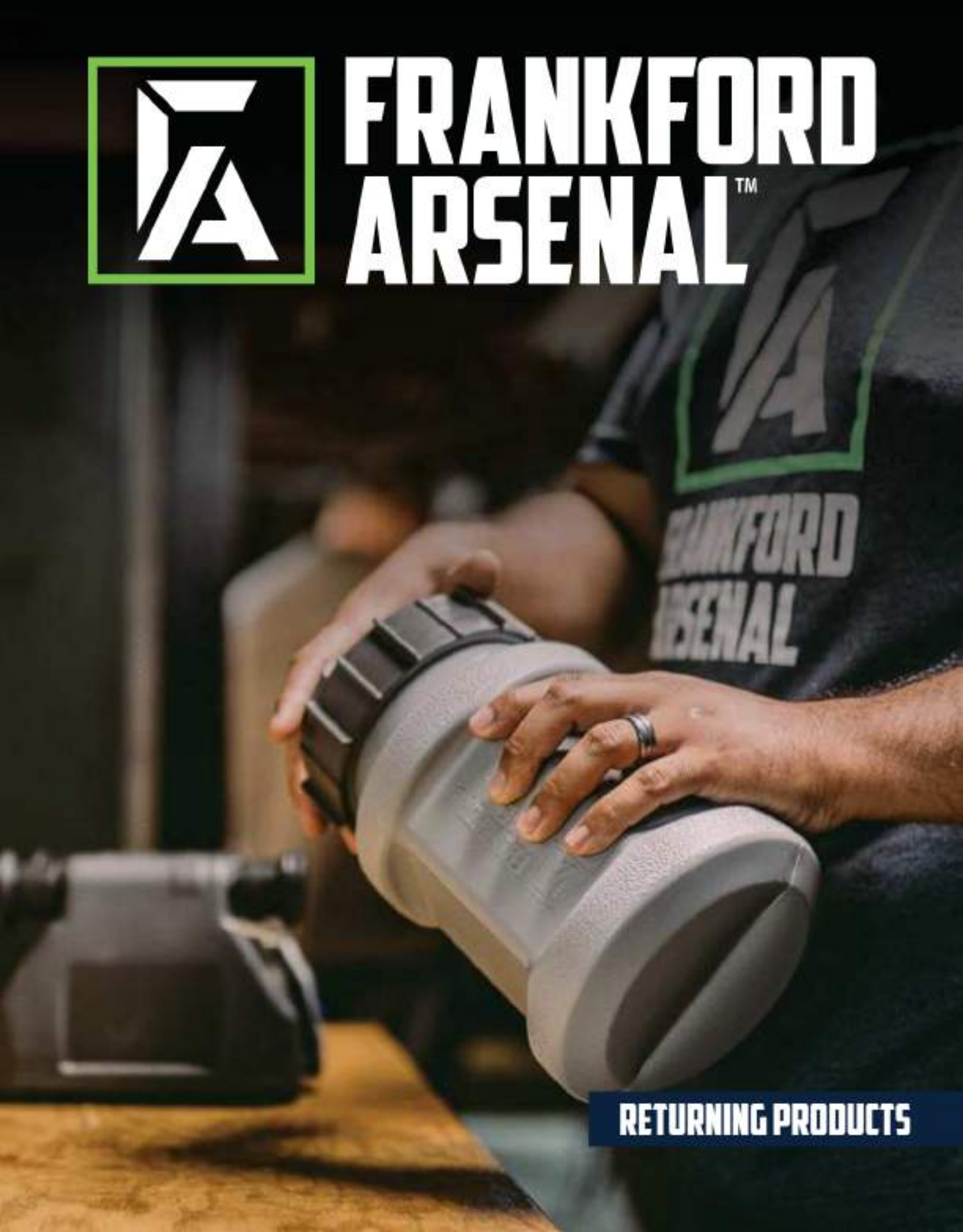

RETURNING PRODUCTS



INTELLIDROPPER® ELECTRONIC POWDER MEASURE #1082250

Patents: www.aob.com/patents

Box Size: 13.5"W x 6.25"H x 7.5"D Case Pack: 2

- Bluetooth® capability
- Large back-lit LCD display with easy-to-see controls
- Stores load data in free downloadable app
- Auto and manual trickle capability
- Self-optimizing powder calibration
- +/- 0.1 grain accuracy



APP FEATURES

- Preloaded bullet and powder databases
- Preloaded cartridge list
- Preloaded powder list (Hodgdon®, Alliant Powder®, etc.)
- Preloaded bullet database with bullet type, weight, ballistic coefficient and sectional density
- Input case, primer, length of barrel and more!



Powder tube holds more than 1 lb. of powder

Powder brush

Quick-dump powder funnel

Calibration weights

Metal dispenser tray

Back-lit touch screen with oversized buttons



Operate the Intellidropper® Powder Measure from the touch screen or use your phone and the App



"The Bluetooth® word mark and logos are registered trademarks owned by Bluetooth SIG, Inc. and any use of such marks by Battenfeld Technologies, Inc.® is under license. Other trademarks and trade names are those of their respective owners."

PILE DRIVER™ BULLET PULLER #1116083

Box Size: 23"W x 7.5"H x 5"D Case Pack: 2

*Patents: www.aaf.com/patents

- Compatible with cartridges up to .30-06
- Mounts vertically to bench or wall
- Low effort lever design uses spring power to pull bullets
- Optional barbed fitting for attaching tube for powder and bullet collection
- Traps bullet and powder in container



Quick change shell holder system holds up to .30-06 cartridges

Magnum shell holder holds up to .338 Lapua cartridges (sold separately - part #1132057)

Low effort lever design uses spring power to pull bullets

Capture bullets and powder in integrated trap or in external container using tube with optional barb fitting





UNIVERSAL BULLET SEATING DIE #1116715

Box Size: 5.5"W x 6.5"H x 1.73"D Case Pack: 4

*Patents: www.aob.com/patents

- Holds bullet in place while seating
- Adjustable seating depth
- 3 VLD seating stems
- Works for .224–.338 Cal
- Standard 7/8" x 14 thread
- Molded storage case
- Built-in micrometer allowing for precise micro-adjustments to the seating depth of the bullet



9 included alignment sleeves
fit calibers .224 to .338

Get precise micro-adjustments
with the built-in micrometer

3 VLD Seating Stems

Convenient storage case
holds die and stems

FRANKFORD ARSENAL®

M-PRESS® COAXIAL RELOADING PRESS #1097879

Patents: www.aab.com/patents

Box Size: 11"W x 18"H x 6"D Case Pack: 2

- Easy-to-adjust Integral Patent Pending sliding universal shellholder system
- Quick-change die blocks fit standard 7/8"-14 reloading dies
- Spent-primer catcher tray
- Loads .22 Hornet - .338 Lapua Magnum sized cases
- 2 parallel guide rods for stability
- Integrated LED light shines onto work area
- Can be set up to Cam Over or not Cam Over
- 3 aluminum die blocks included

Ambidextrous Handle

Heavy-duty cast iron construction

ON/OFF button for integrated LED light

Floating shell holder block allows for precise bullet-to-case alignment

Selectable cam over operation

RELOADING DIES NOT INCLUDED

Removable spent primer tray



NO SHELL HOLDERS NEEDED

Sliding universal shellholders fit cases from .22 Hornet - .338 Lapua Mag. without the need for additional shell holders or parts.



DIE BLOCKS 3 PACK WITH STORAGE CASE #1097880

Box Size: 4.75"W x 6"H x 1.75"D Case Pack: 6

- 3 die blocks for Frankford Arsenal® M-Press™ Reloading Press
- Aluminum construction
- Brass allen set screw keeps die settings in place without ruining threads
- Storage case holds 3 dies with blocks installed
- Storage case is stackable



Die block set allows you to set your dies and store them locked in place in the storage case



ROTARY TUMBLER #909544

Box Size: 11.2"W x 16.1"H x 15.5"D Case Pack: 1

220V ROTARY TUMBLER #909567



Box Size: 11.2"W x 16.1"H x 15.5"D Case Pack: 2

240V NZ ROTARY TUMBLER #1097882

Box Size: 11.2"W x 16.1"H x 15.5"D Case Pack: 2

- Maintenance-free geared drive train
- Large 7 liter capacity (tumbles up to 1,000 cases of .223 brass)
- Dual-layer drum with noise dampening rubber lining

INCLUDES

- Clear cleaning caps
- 5lbs of magnetic stainless steel media
- Frankford Arsenal® brass cleaning concentrated solution sample



SPARE TUMBLER DRUM #909789

Package Size: 9.7"W x 15.9"H x 10.8"D Case Pack: 1

ROTARY TUMBLER LITE #1097878

Box Size: 12.75"W x 12"H x 9.2"D Case Pack: 2

230V ROTARY TUMBLER LITE #109788



Box Size: 12.75"W x 12"H x 9.2"D Case Pack: 2

- Smaller, more compact design
- Easy ON/OFF operation
- Holds up to 300 pieces of .223 brass
- Works great with Frankford Arsenal® stainless steel media
- Leak-proof cap design with rubber seal
- Clear viewing window in cap
- 3.3L capacity



ROTARY TUMBLER STRAINING CAPS #1097883

Bag Size: 5.2"W x 6"H x 0.5"D Case Pack: 10

- Wire mesh straining caps for the Platinum Series Rotary Tumbler and NEW Rotary Tumbler Lite
- Conveniently packaged with 2 Caps to allow through straining on the Rotary Tumbler drum
- Allows you to strain water out of the drums without worrying about losing any tumbling pins



FRANKFORD ARSENAL®

STAINLESS STEEL TUMBLING MEDIA 2 LB. #1097884

Box Size: 4"W x 2.6"H x 2.6"D Case Pack: 4

- Perfect amount to use with the Rotary Tumbler Lite
- Magnetic stainless steel allows you to pick them up with a magnet and they resist rust
- Pins scrub inside case body as well as inside primer pockets
- 304 magnetic stainless steel
- 1mm x 7mm pin size
- Lifetime use

Pins scrub inside case body as well as inside primer pockets



BRASS CLEANING PACKS (24-PACK) #110040

Bag Size: 8"W x 3.5"H x 7.5"D Case Pack: 4

- Quick and effective NEW crystallized, water-soluble formula
- Works with all rotary tumblers
- Resealable bag for easy and secure storage
- Made in the U.S.A.

1 PACK CLEANS
UP TO 500 PIECES
OF BRASS



BRASS CLEANING SOLUTION #878787

Box Size: 3"Diameter x 10"H Case Pack: 4

- 32 oz bottle
- Specifically designed to clean brass cases
- Concentrated formula



MEDIA TRANSFER MAGNET #909271

Box Size: 4.75"W x 9"H x 4.5"D Case Pack: 4

- Easy-grip handle
- 304 stainless steel
- Collects 1mm x 7mm pins





CASE TUMBLER #855020

Box Size: 10.5"W x 7"H x 10.5"D Case Pack: 1

*Patents: www.aob.com/patents

220V CASE TUMBLER #515667



Box Size: 10.5"W x 7"H x 10.5"D Case Pack: 1

*Patents: www.aob.com/patents

- Holds up to 600 9mm cases or 350 .223 cases
- Use with Corn Cob or Walnut Hull media



CASE TUMBLER KIT #645880

*Patents: www.aob.com/patents

Box Size: 12.6"W x 11.8"H x 12.6"D Case Pack: 2

220V CASE TUMBLER KIT #799534



Box Size: 12.6"W x 11.8"H x 12.6"D Case Pack: 1

*Patents: www.aob.com/patents

INCLUDES

- Quick-N-EZ™ Case Tumbler (or 220v)
- Quick-N-EZ™ Rotary Media Separator
- 4oz brass polish
- 3 lbs of cleaning media
- Plastic bucket



STANDARD MEDIA SEPARATOR #121925

Display Size: 10.5"W x 10.3"H x 6.8"D Case Pack: 4

- Perforated bottom separates media from brass
- Fits in 5 gallon bucket



ROTARY SIFTER KIT + 3.5 GAL BUCKET #507565

Box Size: 12.8"W x 12.6"H x 12"D Case Pack: 1

INCLUDES

- Quick-N-EZ™ Rotary Sifter
- (2) splash fins
- Bucket lid



ROTARY SIFTER #683551

Box Size: 11.25"W x 5.25"H x 11.125"D Case Pack: 1

INCLUDES

- (2) splash fins
- (2) bucket supports



FRANKFORD ARSENAL®

CLEANING AND POLISHING SUPPLIES

CORN COB MEDIA:

4.5 lbs in Plastic Tub.....	#287178	Case Pack: 6
7 lbs in Box.....	#108729	Case Pack: 1
15 lbs in Box.....	#446063	Case Pack: 1
15 lbs in 3.5 gal Bucket.....	#687756	Case Pack: 1

TREATED CORN COB MEDIA:

4.5 lbs in Plastic Tub.....	#194524	Case Pack: 6
-----------------------------	---------	--------------

WALNUT HULL MEDIA:

5 lbs in Plastic Tub.....	#881536	Case Pack: 6
18 lbs in Box.....	#496169	Case Pack: 1
18 lbs in 3.5 gal Bucket.....	#636314	Case Pack: 1

TREATED WALNUT HULL MEDIA:

5 lbs in Plastic Tub.....	#347338	Case Pack: 6
17 lbs in Box.....	#331177	Case Pack: 1
18 lbs in 3.5 gal Bucket.....	#636314	Case Pack: 1

BRASS POLISH:

4 oz Bottle.....	#845677	Case Pack: 6
8 oz Bottle.....	#887335	Case Pack: 6
32 oz Bottle.....	#321901	Case Pack: 12



WET/DRY MEDIA SEPARATOR #507567

Box Size: 13.5"W x 13"H x 8.8"D Case Pack: 2

- Ideal for both wet and dry cleaning processes
- (2) sitting handles for ambidextrous use
- Spill proof tub with durable rubber latch
- Mesh strainer for rinsing pins



BRASS DRYER #909213

Box Size: 14.2"W x 14.2"H x 11.4"D Case Pack: 4

220V BRASS DRYER #110123



Box Size: 14.2"W x 14.2"H x 11.4"D Case Pack: 4

- Vented trays provide the best airflow for minimal dry time
- 500 watt heating unit; temperature control ranges 90°-160°F
- Dry up to 1,000 pieces of .223 brass in less than 1 hour
- (5) removable trays
- Separate and dry multiple calibers at once

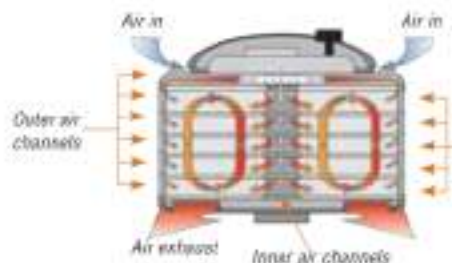

FORCED AIR CONVECTION DRYING SYSTEM

The Frankford Arsenal® Platinum Series Brass Dryer is specifically designed with vented trays, inner and outer layered air flow channels and a large 500 watt Heating System to reduce drying time and maximize efficiency. Forced air convection ensures that the brass gets the maximum amount of airflow available. Air is heated to 160° F then blown through the channels and circulated throughout the trays before being exhausted out the bottom of the dryer.

PRIMER POCKET SWAGER #110007 *Patents: www.aab.com/patents**

Box Size: 5.5"W x 9"H x 5.5"D Case Pack: 2

- Ergonomic upright design with adjustable-position handle
- Quick-change swage pin for large or small primer pocket use
- Benchttop mounting system
- Adjustable brass positioning to ensure a centered swaging pin
- Die-cast aluminum construction
- Auto-eject case pin holder for easy loading and unloading

INCLUDES

- (1) large case holder
- (1) small case holder



HAND DEPRIMER #909283 *Patents: www.aab.com/patents**

Clam Size: 10.8"W x 13"H x 3.5"D Case Pack: 4

- Auto-ejecting case holder for easy removal of deprimed cases
- Easily removable spent primer catch tube
- Works on pistol and rifle brass
- Full-length ergonomic hand grip to deprime military crimped primers



UNIVERSAL PRECISION CASE TRIMMER #1092514 *Patents: www.aab.com/patents**

Box Size: 5.7"W x 4.75"H x 2"D Case Pack: 4

- Adjustable collet system works with all shouldered cases from .17 Remington to .460 Weatherby
- Dual bearing system allows outer housing to float (not spin) while in use
- Works with almost any 3/8" drill or drill press
- Ultra-hard HSS cutter will stay sharp for thousands of rounds
- Micro-adjustable
- Universal Collet System indexes on case shoulders for precise and consistent trimming every time



FRANKFORD ARSENAL®

CASE TRIM AND PREP CENTER #903156 Patents: www.aob.com/patents

Box Size: 8.5"W x 11"H x 7.5"D Case Pack: 2

240V CASE TRIM AND PREP CENTER #1094737 Patents: www.aob.com/patents

Box Size: 8.5"W x 11"H x 2.5"D Case Pack: 2 Patents: www.aob.com/patents

- Adjustable collet system works with all shouldered cases from .17 Remington® to .460 Weatherby®
- (3) accessory output shafts with 8-32 threads
- Ultra-hard HSS cutters stay sharp for thousands of rounds to make trimming quick and easy
- Built-in storage box

INCLUDES

- VLD inside chamfering tool
- Outside deburr tool
- Large primer pocket cleaning tool
- Small primer pocket cleaning tool
- 3 sizes of body collets
- 6 sizes of case shoulder bushings



CASE PREP CENTER #1077094

Box Size: 6.7"W x 5"H x 6.5"D Case Pack: 2

- (4) powered tool stations
- Hardened High Speed Steel (HSS) tools
- 8-32 threaded output shafts
- 200 RPM output shafts
- Durable aluminum design

INCLUDES

- Inside chamfer tool
- Outside deburring tool
- Small primer pocket scraper
- Large primer pocket scraper

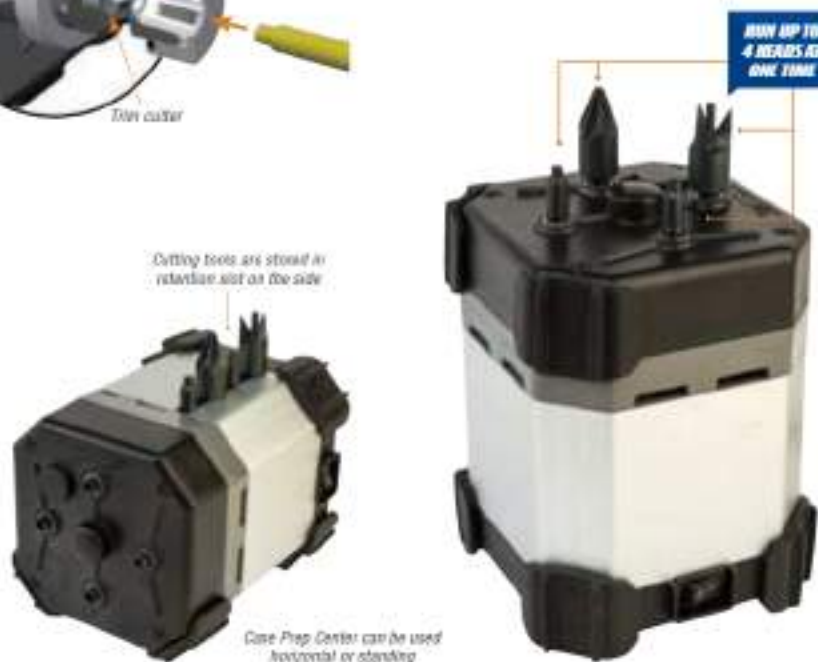

CASE PREP EXPANSION KIT #909215

Box Size: 4.3"W x 4.5"H x 1"D Case Pack: 4

- Hardened High Speed Steel (HSS) large and small primer pocket uniformer/cleaner
- Large and small primer pocket crimp remover
- Standard 8-32 threads fit Frankford® Case Prep Center, Case Trim & Prep Center



STUCK CASE REMOVER #1078192

Clam Size: 3.6"W x 7.4"H x 1.25"D Case Pack: 4

Patents: www.aob.com/patents

- Provides optimal leverage with use of reloading press
- Case removal with no extra tools required
- No need to remove or adjust the sizing die





CASE PREP ESSENTIALS KIT #909214

Box Size: 4.25"W x 4"H x 2.25"D Case Pack: 4

INCLUDES

- Inside chamfer tool
- Outside deburring tool
- Large and small primer pocket crimp cutter tools
- Large and small pocket uniformer (cleaner)
- Handy storage case
- (2) rubber coated handles



PRECISION POWDER SCALE #909672



Box Size: 10.75"W x 9"H x 3.25"D Case Pack: 4

- Measurements: grains, grams, carats and ounces
- Auto shutoff after 180 seconds
- Stability indicator
- Capacity: 1,500 grain (100g)
- Accuracy: +0.1 grain (0.01g)
- Tare function
- Protective cover

INCLUDES

- (2) calibration weights for a 3-point calibration
- Powder pan
- Clear, protective cover
- Storage case
- (4) AAA batteries
- 110v power supply/220v adapter



DS-750 DIGITAL SCALE #205205

Clam Size: 4.75"W x 8.6"H x 1.75"D Case Pack: 4

- Capacity: 750 grain (50g)
- Accuracy: ±0.1 grain (0.01g)
- LCD display with blue backlight
- Measures in: grains, grams, carats and ounces
- Tare function and counting function
- Auto shutoff after 60 seconds

INCLUDES

- Calibration weight
- Powder pan
- Clear, protective cover
- Soft carry case
- (2) AAA batteries



POWDER TRICKLER #903535

Box Size: 6.25"W x 8"H x 3"D Case Pack: 6

- Large powder capacity (8.2cc)
- Heavy-machined steel to prevent tipping
- Synthetic dust cover doubles as non-skid base



FRANKFORD ARSENAL®

PERFECT SEAT HAND PRIMER #110006

*Patents: www.aab.com/patents

Box Size: 8.5"W x 11"H x 2.5"D Case Pack: 4

- Hard stop prevents crushing primers
- Primer tray holds 100+ primers
- Thumb release easily switches from large to small primers
- Adjust seating depth by the 0.001" increments

INCLUDES

- Includes (12) shell holders, works on over 265 calibers
- Molded storage case



VIBRA-PRIME™ #855712

Box Size: 7"W x 20.2"H x 1.3"D Case Pack: 4

- Works with large and small primers
- Circular auto-indexing ridges for quick primer insertion
- Runs on 2 AA batteries (not included)

INCLUDES

- Vibra-Prime™
- (1) primer tray
- (1) small primer tube
- (1) large primer tube
- (2) universal tube adapters



A. CLEANCAST LEAD FLUXING COMPOUND #441888

Jar Size: 3.6"W x 3.9"H x 3.6"D Case Pack: 6

B. CASE LUBE #460478

Can Size: 8 oz 5.1" H x 2" Dia. Case Pack: 12

C. DROP OUT #763758

Can Size: 2.25"W x 6.75"H x 2.25"D Case Pack: 6

The modern way to "smoke" bullet molds. Applied to the cavities of a cold, clean bullet mold, Frankford Arsenal® Drop Out literally allows the just-cast bullets to "drop-out" with no tapping or pounding.



CASE NECK LUBRICATOR

Case Neck Lubricator #132530

Box Size: 3.5"W x 3.5"H x 6.25"D Case Pack: 1

Fine Powdered Mica (.01 oz packet) #595042

Box Size: 2"W x 0.125"H x 3.5"D Case Pack: 1

Fine Powdered Mica (4 oz jar) 757780

Box Size: 3.6"W x 3.7"H x 3.9"D Case Pack: 1





RELOADING STAND #489621

Box Size: 26.5"W x 27.8"H x 5.2"D Case Pack: 1

- Tabletop width adjustable from 13"-30"
- Tabletop height adjustable from 28.5"-45"
- Frame made of 1.5" tube steel



IMPACT BULLET PULLER #836017

Box Size: 6"W x 14"H x 2"D Case Pack: 6

REPLACEMENT ALUMINUM COLLET SET (3-PACK) #737910

Box Size: 4"W x 3"H x 2"D Case Pack: 6

IMPACT BULLET PULLER INCLUDES

- (3) different sized aluminum collets



CALIPERS

A. Electronic Calipers #672060

B. Stainless Steel Dial Calipers #516503

Box Size: 8"W x 12.25"H x 1"D Case Pack: 6

BOTH CALIPERS INCLUDE

- Protective storage case

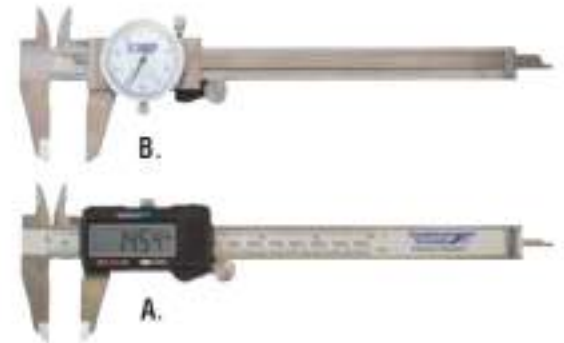

CARTRIDGE OVERALL LENGTH GAUGE #965887

Box Size: 4"W x 6.2"H x .5"D Case Pack: 6

This simple kit consists of two clamps that easily attach to any cleaning rod, 1/4" in diameter, or less!



FRANKFORD ARSENAL®

UNIVERSAL RELOADING TRAY #393939

Box Size: 5.5"W x 1.1"H x 11.2"D Case Pack: 6

The Universal Reloading Tray can be used with a wide variety of rifle cartridges from .17 caliber up to .458 caliber. It also works well for handgun cartridges from 9mm to 500 S&W with a 50 round capacity. It conveniently holds brass during different stages of the reloading process.

BOTTOM



TOP

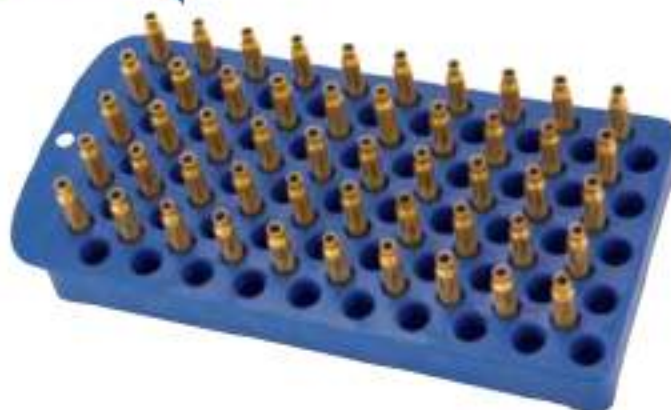

AMMO VAULT® Patents: www.uspto.com/patents

RMD-20 #912600

RLG-20 #912610

Clam Size: 6.25"W X 8.4"H x 2"D Case Pack: 4

- Holds (20) rounds of ammunition
- Integrated locking system secures lid in place
- Impact-resistant material
- Foam insert holds cartridges securely, prevents rattling and protects bullet tips



Adjustable height accommodates several different cartridges



RELOADER'S LABEL (100-PACK) #202364

Clam Size: 3.75"W X 5.75"H x 1"D Case Pack: 6



**PEEL & STICK
ADHESIVE
BACKING**





HINGE TOP AMMO BOXES

Case Pack: 10

- Mechanical plastic hinge for stronger lid
- Can place 1" x 2 5/8" printer I.D. labels on the lid
- Come in 50-rnd. and 100-rnd. options
- Easily stackable and the hinged lid will lay flat

100-Round Boxes

Box #1001	#1083797
Box #1003	#1083794
Box #1005	#1083799
Box #1007	#1083800
Box #1008	#1083798
Box #1009	#1083801

50-Round Boxes

Box #501	#1083783
Box #503	#1083784
Box #504	#1083785
Box #505	#1083786
Box #506	#1083787
Box #507	#1083789
Box #508	#1083792
Box #509	#1083788
Box #510	#1083790
Box #511	#1083791
Box #512	#1083793
Box #514	#1083795
Box #515	#1083796



	100rd Box	50rd Box
RIFLE		
17 Remington	1005	505
22 Hornet		504
22 Remington Jaf		504
218 Box		504
221 Remington		504
22 BR		512
22 PPC		512
222 Remington	1005	505
223 Remington	1005	505
222 Remington Mag	1005	505
22-250 Remington	1000	500
228 S&W	1000	500
243 Winchester	1000	500
6mm BR		512
6mm Remington	1000	500
243 Weatherby Mag		510
25-28 WCF	1000	500
257 Roberts	1000	500
250 Savage	1000	500
25-06 Remington		510
6.5mm Swedish Mauser		510
6.5mm Remington Mag		511
6.8mm SFC		512
270 Winchester		510
270 Weatherby Mag		511
270 WSM		515
7x57 Mauser		510
7mm BR	1000	512
7mm SAUM		515
7mm WSM		515
7mm-08	1000	500
298 Remington		510
7mm Remington Mag		511
77 Remington Ultra Mag		511
Shot Ultra Mag		511
30 M1 Carbine		504
30 Remington	1000	500
30-30 Winchester	1000	500
300 Savage	1000	500
30-40 Krag		510
30R Winchester	1000	500
30-06 Springfield		510
308 H&H Mag		511
30R Winchester Mag		511
30R Ultra Mag		511
Shot Ultra Mag		511
308 SAUM	515	
308 WSM		515
300 Weatherby Mag		511
303 British		510
7.62mm	1000	512
32-28 WCF	1000	500
32 Winchester Jpr		506
8x57 Mauser		510
8mm Remington Mag		511
32R Winchester Mag		511
338 Lapua Mag		511
340 Weatherby Mag		511
308 Rem Ultra Mag		511
35 Remington Mag	1000	500

33 Whelen		510
375 H&H Mag		511
375 Rem Ultra Mag		511
378 Weatherby Mag		511
38-40 WCF		507
38-54 WCF		514
38-70 WCF		514
40-40 WCF		514
40-65 Ballist		514
404 Jofary		511
40S Winchester		510
416 Taylor		511
418 Rigby		511
444 Marlin	1000	500
45-70 Govt	1000	514
45-06 WCF		511
45-100 Sharps		511
45R Winchester Mag		511
50-70 Govt		514
50 118 WCF		514

PISTOL

25 ACP	1001	501
32 ACP	1001	501
32 S&W/32 S&W Long	1003	503
32 H&R Magnum	1003	503
38 Auto	1001	501
38 Smith & Wesson	1001	501
38 S&W	1003	503
38 Special	1003	503
38 Super	1003	503
357 Magnum	1003	503
357 Maxvan		505
357 Auto Mag		507
380 Auto	1000	500
40 S&W	1000	500
41 Long Colt	1007	507
41 Magnum	1007	507
44 S&W Russian	1007	507
44 Colt	1007	507
44 Special	1007	507
44-48 WCF	1007	507
44 Magnum	1007	507
44S Super Mag	1000	500
44 Auto Mag	1007	507
45 S&W Schofield	1007	507
45 ACP	1000	500
45 Auto Rim	1000	500
45 Colt	1007	507
45 Winchester Magnum	1007	507
454 Casull	1007	507
460 S&W		514
480 Ruger		508
475 Linebaugh		506
50 AE		506
500 Linebaugh		506
SHOTGUN		
.410 Gauge 2.5" Shells		509
.410 Gauge 3" Shells		510
20 Gauge		514

Tipton®



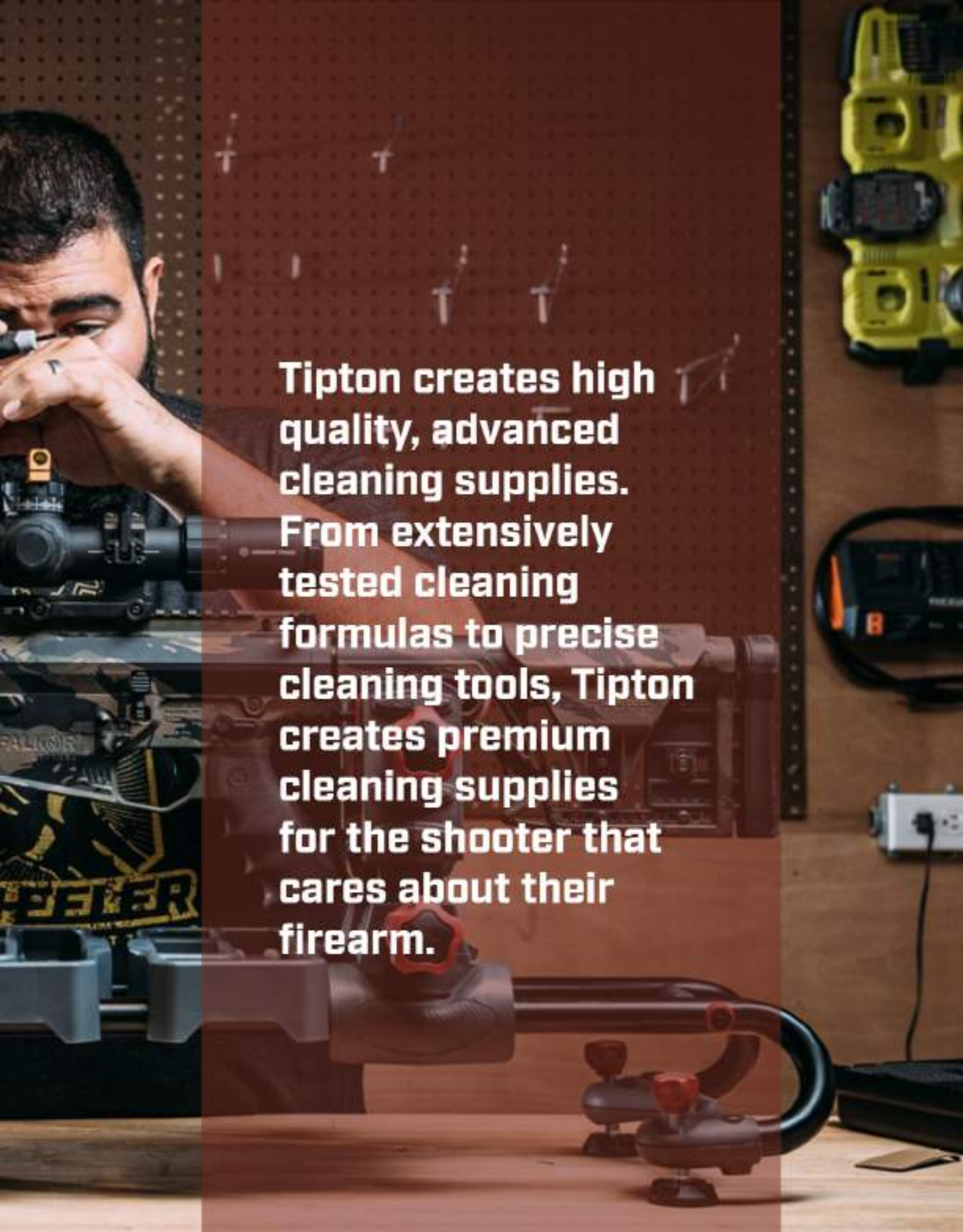

Tipton creates high quality, advanced cleaning supplies. From extensively tested cleaning formulas to precise cleaning tools, Tipton creates premium cleaning supplies for the shooter that cares about their firearm.



Tipton®

Tipton®

2021 New Products



NOPE ROPE™

Bag Size: 180 Case Pack: 4 *Patents: www.aob.com/patents*

- Durable pull-through bore cleaning ropes
- 2 Pack for 9mm, .223, & 12ga
- Attachable ends allow user to continuously clean without re-loading end into barrel with each pass
- Convenient mess-free storage box
- Say nope to: carbon, copper, debris, grime, and rust

NOPE ROPE SIZES

Product #	Caliber
#1149250	9mm, .380, .38 cal
#1149256	12 ga
#1149257	.20 ga
#1149251	.40 cal
#1149252	.44 cal, .45 cal
#1149253	.22 cal, .223 cal, 5.56mm
#1149254	.6mm
#1149255	.6.5mm
#1149248	.7mm
#1149249	.30 cal, .308, .30-30, .300blk, 7.62mm

NOPE ROPE SIZES (2 PACK)

Product #	Caliber
#1136047	9mm, .380, .38 cal (2 pack)
#1149256	12 ga (2 pack)
#1136050	.22 cal, .223 cal, 5.56mm (2 pack)

Tipton®

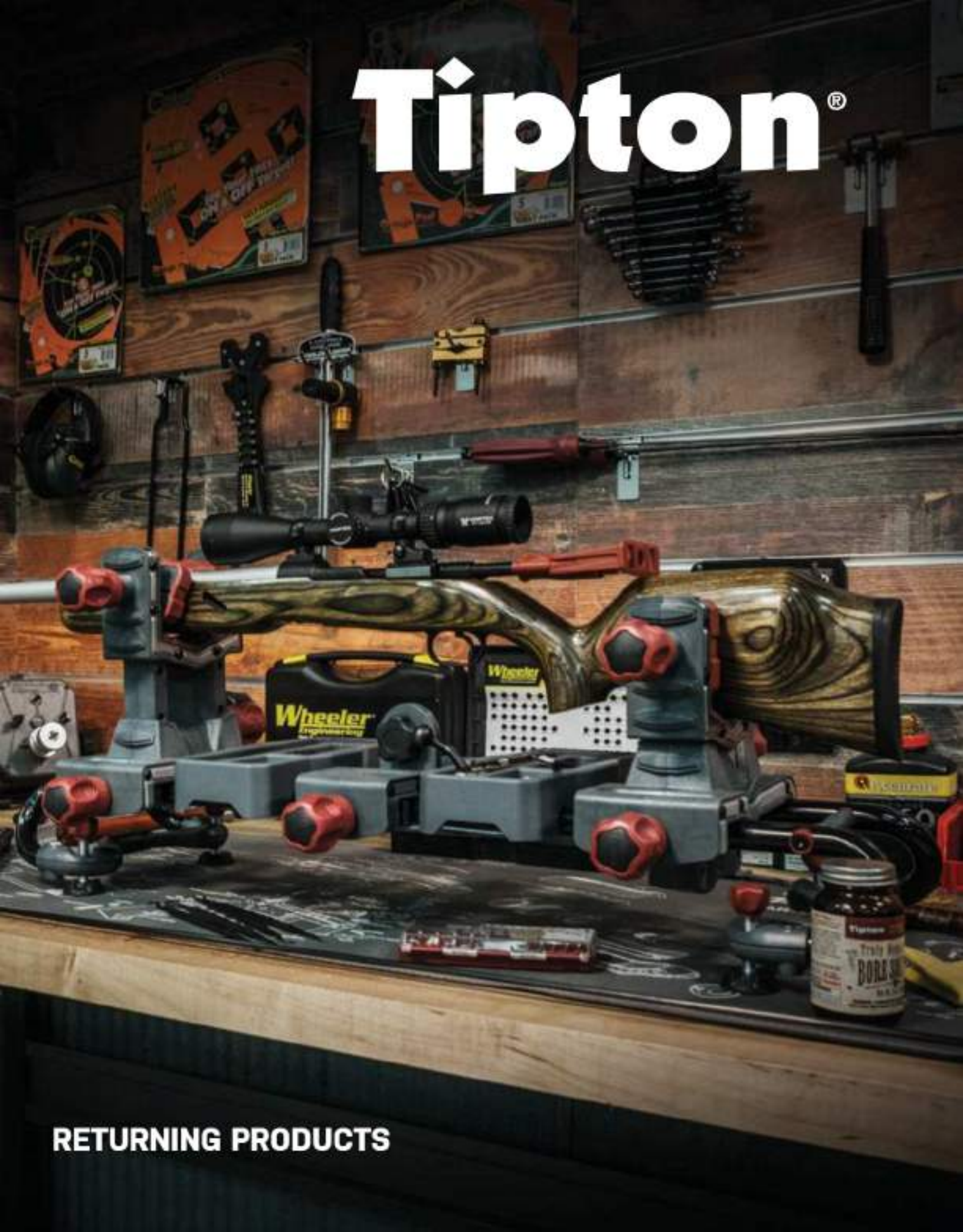

RETURNING PRODUCTS

FELT CLEANING PELLETS

Bag Size: 4.75"W x 7"H x 1"D Case Pack: 10

- Compressed felt pellets .17-.50 cal
- Pellets are tough and durable for superior cleaning
- Easier to use than patches
- Each pack includes 1 caliber-correct brass jag
- Available in a multi-caliber pistol kit with assorted pellets and jags



Pellets provide more consistent fit in lands and grooves of rifling for superior cleaning.

FELT CLEANING PELLET PACKS

Product #	Caliber	Pellet Count
#1099933	.17 cal	100ct
#1099934	.20 cal	100ct
#1099935	.22 cal	100ct
#1099936	.243/6mm	100ct
#1099937	.25/6.5mm	100ct
#1099938	.270/7mm	50ct
#1099939	.30/32 cal/8mm	50ct
#1099932	.338	50ct
#1099940	.35/9mm/.38 cal	50ct
#1099941	.375 cal	50ct
#1099942	.40 cal	50ct
#1099943	.44/45 cal	50ct
#1099944	.50 cal	50ct

COMPLETE PISTOL PELLET KIT #1099945

Box Size: 10"W x 7.5"H x 2.5"D Case Pack: 10

- Kit includes .22, 9mm, .40, .44/.45 caliber sized pellets and cleaning jags
- .22 cal pellets are 100ct, 9mm, .40, .44/.45 cal pellets are 50ct
- Plastic storage case with components

SINGLE REPLACEMENT PELLET JAGS

Glam Size: 2"W x 7"H x .75"D Case Pack: 5

Product #	Caliber
#1100132	.17 cal
#1100133	.20 cal
#1100134	.22 - .264 cal
#1100124	.270 - .375 cal
#1100130	.40 - .50 cal



POWER SWABS

Case Pack: 10

- Durable cotton swab construction
- 7.5" flexible bamboo handle
- Disposable
- Fits lands and grooves better than a patch for maximum cleaning
- No mess cleaning
- Fast and easy to use
- Pointed Tip swab has heavy-duty tapered end
- General Cleaning Tip is heavy-duty and rounded

Product #	Caliber	Pellet Count
#1099924	.22 cal	250ct
#1099925	9mm/.38 cal	175ct
#1099926	.40 cal	100ct
#1099927	.44/.45 cal	100ct
#1099928	.50 cal	100ct
#1099929	Pointed Tip	300ct
#1099931	Cleaning Tip	400ct



COMPLETE PISTOL POWER SWAB KIT #1099930

Box Size: 13"W x 9"H x 2.5"D Case Pack: 5

- Kit includes 50ct of .22, 9mm, .40, .44/.45 swabs
- Kit includes 100ct General Cleaning Tip swabs
- Kit includes 100ct Pointed Tip swabs
- Plastic storage case



STANDING ULTRA GUN VISE #1094247

Box Size: 44.5"W x 12.5"H x 9.5"D Case Pack: 1

- Ultra Gun Vise modular chassis included
- Free standing, 4-leg system removes the need for a table or bench
- Oversized levers for easy leg deployment
- 35" height for optimal comfort while working
- Lightweight - weighs approximately 20 lbs
- Built-in bottle opener
- Makes cleaning convenient in the field or on the range

ULTRA GUN VISE MODULES Patents: www.aob.com/patents

- Non-marring, glass-filled nylon vise/clamp construction
- Ball and socket articulating clamp pads allow for the pads to adapt to any firearm's surface
- Front and rear clamps are both height and length adjustable
- Mountable directly to horizontal rails
- Removable accessory/tool trays

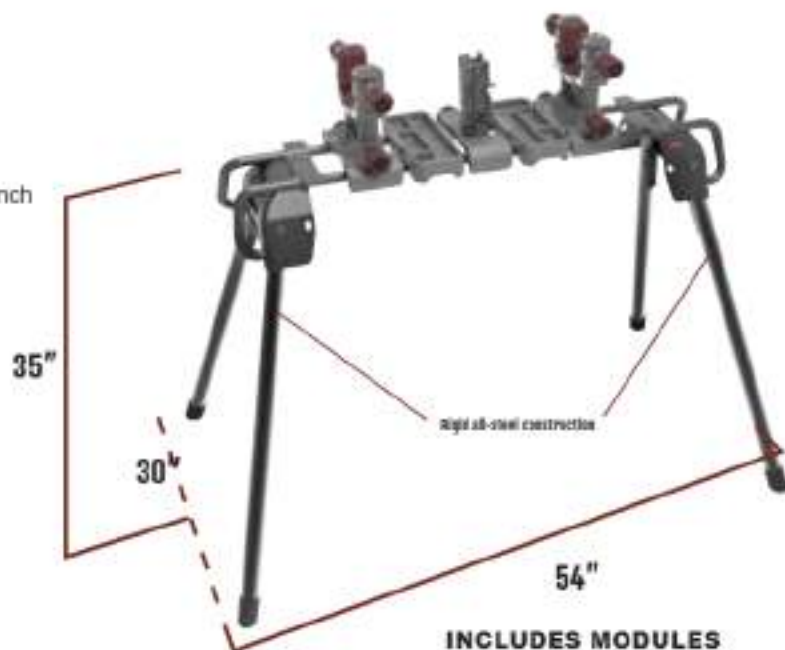

Collapsible for easy storage and transport

INCLUDES MODULES FROM THE ULTRA GUN VISE FOR MAXIMUM VERSATILITY

UNIVERSAL GUN MAINTENANCE STAND #1093522

Box Size: 44"W x 12"H x 9"D Case Pack: 1

- Freestanding, 4-leg system removes the need for a table or bench
- Oversized levers for easy leg deployment
- 35" height for optimal comfort while working
- Lightweight - weighs approximately 20 lbs
- Built-in bottle opener
- Makes cleaning convenient in the field or on the range
- Built-in wings allow you to mount a Best Gun Vise to the stand

Steel rails will accept the Ultra Gun Vise Modules for freestanding use



Includes mounts to attach your Best Gun Vise or Gun Vise directly to the stand

Rigid all-steel construction



Collapsible for easy storage and transport

ULTRA GUN VISE #110011

Patents: www.acb.com/patents

Box Size: 33"W x 12.25"H x 5.5"D Case Pack: 2

- Non-marring, glass-filled nylon vise/clamp construction
- Durable steel tube frame structure
- Ball and socket articulating clamp pads allow for the pads to adapt to any firearm's surface
- Front and rear clamps both height and length adjustable
- (4) independently-adjustable, non-slip feet
- Mountable directly to benchtop (*hardware not included*)
- Removable accessory/tool trays



32.5"W x 11"W x 10.5"D

**INTERCHANGEABLE
MODULAR DESIGN**



BEST GUN VISE #181181

Patents: www.acb.com/patents

Box Size: 33"W x 8.5"H x 5.7"D Case Pack: 4

- Non-marring surfaces
- Durable polymer construction
- Mountable directly to benchtop (*hardware not included*)
- Front and rear base slide on center aluminum rail for optimum length adjustments
- Accommodates multiple different firearms and projects
- Adjustable rear off-set clamping mechanism
- (4) non-slip rubber feet

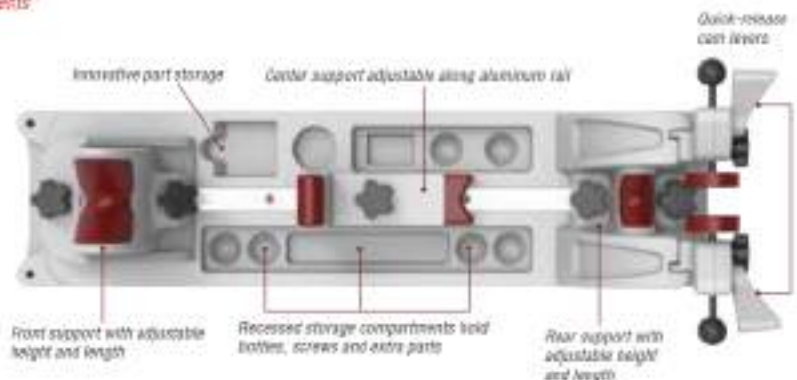

Exposes the breech on any break-open shotgun for easy cleaning or inspection



Versatile clamp and support system accommodates pistols and revolvers



Levels and holds conventional rifles for maintenance and cleaning



Holds AR style rifles open to gain access to bore, receiver and fire control components

GUN VISE #782731

Box Size: 34"W x 11"H x 9"D Case Pack: 3

- Non-marring surfaces
- Durable polymer construction
- Accommodates multiple different firearms and projects
- (4) non-slip rubber feet
- (8) recessed storage compartments

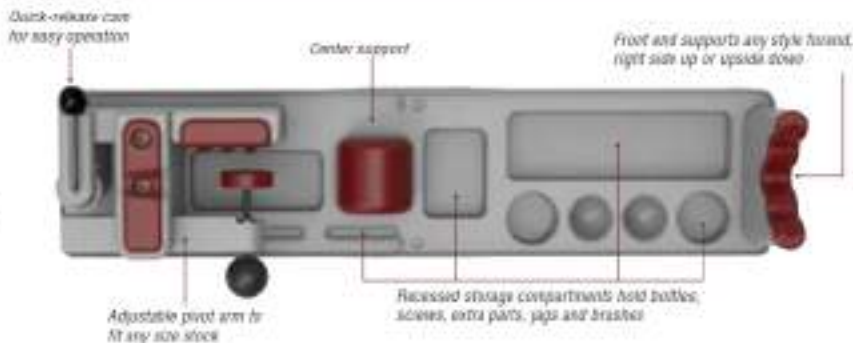

Cleaves down shotguns



Clean bolt actions



Secures AR style rifles

GUN BUTLER #100333

Box Size: 23"W x 9"H x 4.7"D Case Pack: 6

- (2) removable, non-marring forks to securely hold firearm
- Durable polymer construction
- Convenient recessed storage compartments
- Center carry-handle



COMPACT RANGE VISE #282282

Clam Size: 13.5"W x 10.5"H x 7.5"D Case Pack: 6

- Durable, solvent-resistant nylon and polymer construction
- Collapses for easy storage or transport in a range bag
- (6) non-slip rubber feet
- Non-marring contact surfaces
- Collapses to 2.75" tall



3.5"W x 17.75"W (extended) x 7.5"D



1911 MAG WELL VISE BLOCK #558080

Clam Size: 7.5"W x 12.2"H x 2.6"D Case Pack: 4

*Patents: www.uspto.gov/patents

- Non-marring surfaces
- Built-in barrel bushing wrench
- Removable mag well arm
- Solvent-resistant polymer construction
- Mountable directly to benchtop or Tipton® Best Gun Vise



Built-in barrel bushing wrench makes removal easy



DELUXE CARBON FIBER RODS USED BY THE U.S. MILITARY



DELUXE CARBON FIBER CLEANING ROD™ (1-PIECE)

Hang Tube Size: 1.5" Diameter Case Pack: 4

CALIBER	LENGTH					
	12"	26"	36"	40"	44"	50"
.17-.20		#146468R	#107486R			
.20				#175401R		
.22-.26	#658675R	#216411R	#430686R	#182978R	#783485R	
.27-.45	#303569R	#376252R	#720747R	#413662R	#509320R	#751235R
.40+						
SHOTGUN			#713415R			

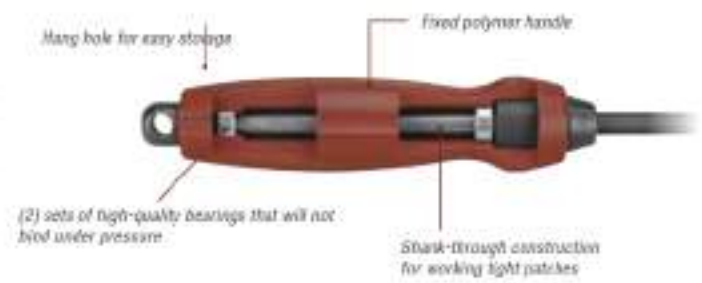

MAX FORCE™ CLEANING RODS

Patents: www.aob.com/patents

.22 Caliber #658539

Clam Size: 7"W x 50.125"H x 1.75"D Case Pack: 4

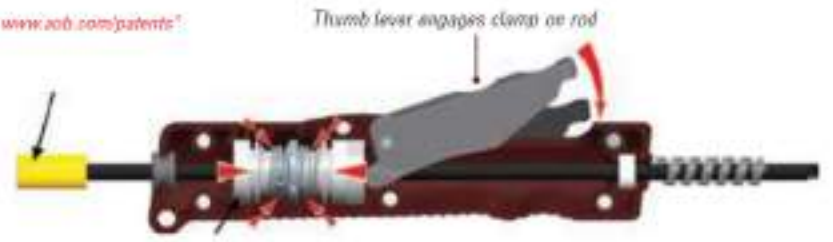

- Handle slides freely, lockable at any point along rod
- 40" usable rod length
- Carbon fiber shaft will not embed particles that could damage the rifle bore
- Highly-durable; no bending or breaking
- Solvent-resistant polymer handle
- .17-.20 caliber has 5-40 threads
- .22 caliber has 8-32 threads



ROD RACK #100335

Display Size: 6"W x 18"H x 2.5"D Case Pack: 4

- Accommodates (5) rods of various sizes
- (2) hanging hooks on either end for additional accessories

INCLUDES

- Mounting holes and screws



ULTRA CLEANING KIT #554400

Patents: www.aob.com/patents

Display Size: 16.85"W x 10.67"H x 3.25"D Case Pack: 2

INCLUDES

- 3-piece Premium Stainless Steel Rod
- RAPID™ Deluxe Bore Guide kit
- 13-piece Ultra Jag™ Set with case
- 13-piece Best Bore Brush™ Set with case
- (2) general purpose brushes
 - (1) nylon
 - (1) bronze
- AR-15 bolt carrier and action brushes
- (4) polymer cleaning picks
- Carry case with molded-foam inserts



RAPID™ DELUXE BORE GUIDE KIT #777999

Claim Size: 7"W x 17.25"H x 3"D Case Pack: 4

- Ensures proper rod alignment for easier cleaning
- Bore guides protect chamber and bore from damage
- Anodized aluminum tube for durability
- Fits most bolt-action rifles and AR-15s

INCLUDES

- (3) bore guide tips
- (3) brass muzzle guides
- (2) pipettes
- 10/22 muzzle guide
- Bore guide solvent port
- Bolt-action collar
- AR-15 collar
- Standard length tube
- Extra long tube
- Plastic molded storage case



UNIVERSAL BORE GUIDE KIT #777888

Claim Size: 7"W x 17.25"H x 3"D Case Pack: 4

- Anodized aluminum tube for durability
- Fits most bolt-action rifles and AR-15s

INCLUDES

- (3) bore guide tips
- Bore guide solvent port
- Bolt-action collar
- AR-15 collar
- Standard length tube



COMPACT PISTOL CLEANING KIT #1082252

Clam Size: 4"W x 6.5"H x 2"D Case Pack: 6

- For use on pistol calibers ranging from .22-.45
- Collapsible cleaning rod with rotating T-handle
- Stainless steel cleaning rod

INCLUDES

- Cleaning pick
- (10) cotton cleaning patches
- Nylon cleaning brush
- Bronze pistol brushes
 - .22 cal
 - 9mm/.357/.38 cal
 - .40/10mm cal
 - .45 cal
- Nylon jags
 - .22 cal
 - 9mm/.357/.38 cal
 - .40/10mm cal
 - .45 cal
- (2) nylon slotted tips



BRASS JAG SET #749245

Clam Size: 7.5"W x 7"H x 1"D Case Pack: 6

- Durable, hinged-box
- Jags made of solid brass

INCLUDES

- .17
- .20
- .22
- .243/6mm
- .25/6.5mm
- .270/7mm
- .30
- .338/8mm
- .5/9mm
- .375
- .40
- .44
- .45



*ALL JAGS AND BORE BRUSHES HAVE 8-32 THREADS; .17 AND .20 CALIBER HAVE 5-40 THREADS

INDIVIDUAL SOLID BRASS JAGS

Clam Sizes: 2"W x 7"H x 1.75"D Case Pack: 6

CALIBER

.17	#154070	.338/8mm	#485467
.20	#589555	.35/9mm	#434832
.22	#356987	.45	#239013
.243/6mm	#696435		
.25/6.5mm	#584696		
.270/7mm	#768059		
.30/.32	#193225		



ULTRA JAG™

Patents: www.aob.com/patents

Clam Size: 2"W x 7"H x .75"D Case Pack: 5

CALIBER

.17.....	#175543		
.20.....	#589546		
.22.....	#225659		
.243/6mm.....	#243865	.35/9mm.....	#348359
.25/6.5mm.....	#255684	.375.....	#375375
.270/7mm.....	#277555	.40/416.....	#404169
.30/.32.....	#303033	.44.....	#444444
.338/8mm.....	#338338	.45.....	#454545



ULTRA JAG™ SET #500012

Clam Size: 6.5"W x 6.5"H x 1.4"D Case Pack: 6

Patents: www.aob.com/patents

CALIBERS INCLUDED

.17	.25/6.5mm	.375
.20	.270/7mm	.40
.22	.30	.44
.243/6mm	.338/8mm	.45
	.5/9mm	



BEST BORE BRUSH SET #402173

Clam Size: 7.5"W x 7"H x 1"D Case Pack: 6

CALIBERS INCLUDED

.17	.25/6.5mm	.375
.20	.270/7mm	.40
.22	.30	.44
.243/6mm	.338/8mm	.45
	.5/9mm	



ULTRA JAG™ BEST BORE BRUSH SET #444777

Clam Size: 7.5"W x 8.5"H x 2"D Case Pack: 6

Patents: www.aob.com/patents

CALIBERS INCLUDED

.17	.270/7mm	.40
.20	.30	.44
.22	.338/8mm	.45
.243/6mm	.5/9mm	
.25/6.5mm	.375	



BEST BORE BRUSHES

Clam Size: 2"W x 7"H x 1.75"D Case Pack: 5

- All components are non-marring, made from high-quality bronze
- 20% more bristles than standard brushes

CALIBER	3-PACK	10-PACK
.17	#212009	
.20	#559638	
.22	#140337	#882927
.243/6mm	#758284	
.25/6.5mm	#657930	
.270/7mm	#622858	
.30/.32	#868556	#634045

CALIBER	3-PACK
.338/8mm	#427343
.35/9mm	#506367
.375	#127759
.40/.416	#317183
.44	#629958
.45	#211233
.50 BMG	#561865



**20% MORE
BRISTLES THAN
STANDARD BRUSHES**

Wire-through coupler for maximum strength

BRONZE BORE BRUSHES

Clam Sizes: 2"W x 7"H x 1.75"D Case Pack: 5

RIFLE	3-PACK	PISTOL	3-PACK
.17	#244601	.22	#770767
.20	#244500	.32	#892661
.22	#162429	.38/9mm Auto	#631419
.243/6mm	#244510	.41/10mm Auto	#223504
.25/6.5mm	#244520	.44	#670133
.270/7mm	#244530	.45	#737502
.30/.32	#244540	.480	#141054
.35/9	#244560		
.375	#244570	SHOTGUN	
.45	#244595	12 gauge	#612735
	10-PACK	16 gauge	#383231
.22	#466875	20 gauge	#215223
.30/.32	#113901	.410 gauge	#286637



NYLON BRUSHES

Clam Size: 2"W x 7"H x 1.25"D Case Pack: 5

RIFLE	3-PACK		
.17	#698306	.375	#468708
.22	#749051	.40/.416	#582325
.243/6mm	#176683	.44	#303351
.25/6.5mm	#559632	.45	#244597
.270/7mm	#887541		10-PACK
.30/.32	#125012	.22	#690246
.338/8mm	#437445	.30/.32	#479395
.35/9mm	#105458		



BORE BRUSH SETS

Clam Size: 7.5"W x 7"H x 1"D Case Pack: 6

13-PIECE SET

Bronze Rifle Set..... #168577

Nylon Rifle Set..... #615333

8-PIECE SET

Bronze Handgun Set..... #845102

Bronze Shotgun Set..... #671861

RIFLE SET

- .17
- .20
- .22
- .243/6mm
- .25/6.5mm
- .270/7mm
- .30
- .338/8mm
- .5/9mm
- .375
- .40
- .44
- .45

PISTOL SET

- .22
- .243/6mm
- .25/6.5mm
- .270/7mm
- .30
- .338/8mm
- .5/9mm
- .375
- .40
- .44
- .45
- .47/.48

SHOTGUN SET

- .410 ga
- 28 ga
- 20 ga
- 16 ga
- 12 ga
- 10 ga



SOLID BRASS SLOTTED TIPS

Clam Size: 2"W x 7"H x 1.75"D
Case Pack: 5

Set of 4 #554428
(.22-.29, .30-.35, .35-.44 and .45 calibers)

CALIBER

.22-.29 #428953

.30-.35 #211422

.35-.44 #777753

.45+ #400385

Universal Shotgun #339005



BORE MOPS

Clam Size: 2"W x 7"H x 1.75"D

CALIBER

3-PACK

.17 #312659 Case Pack: 1

.22-.25 #653568 Case Pack: 5

6.5mm-.338 #386626 Case Pack: 5

8mm-.375 #181031 Case Pack: 5

.40-.45 #676648 Case Pack: 5

10-12 gauge #657972 Case Pack: 5

16-20 gauge #681324 Case Pack: 5

.410 gauge #242967 Case Pack: 5



CLEANING PATCHES

Case Pack: 5

CALIBER

100-PACK

.17-.22 #476217

.22-.270 #359811

.27-.35 #444068

.35-.50/20 gauge #192431

250-PACK

.45-.58 Black Powder #784909

500-PACK

.35-.50/20 gauge #364206

10, 12, 16 gauge #470796

1,000-PACK

.17-.22 #652376

.22-.270 #618061

.27-.35 #279375



GUN CLEANING PICKS SET OF 4

Polymer #549864

Stainless Steel #324770

Clam Size: 4.5"W x 11.5"H x 5"D

Case Pack: 6

Stainless Steel Cleaning Picks



DOUBLE ENDED CLEANING BRUSHES #654866

Clam Size: 4.85"W x 11"H x .75"D Case Pack: 6

INCLUDES

- (2) nylon brushes
- (1) bronze brush



MAGAZINE CLEANING BRUSH #567575

Clam Size: 3.75"W x 13.75"H x 1.5"D Case Pack: 4

- Works on most single and double-stack magazines (including AR mags, 1911 mags and most double-stack pistol mags)
- Solvent resistant nylon bristles



CLEAN AND OIL BRUSH #375777

Display Size: 1.9"W x 5.9"H x 1.5"D Case Pack: 5

- Fine 1-3/4" bristles
- Wood handle



SHOOTER SWABS

50-count #757554

Bag Size: 9.6"W x 5.9"H x 2"D Case Pack: 6

100-count #350379

Clam Size: 9.5"W x 8.1"H x 2.4"D Case Pack: 6

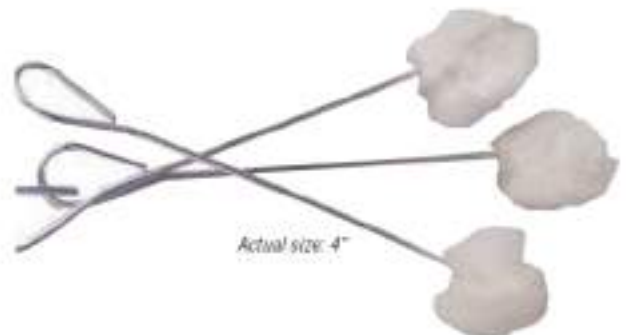

Actual size: 4"

ACTION/CHAMBER CLEANING TOOL SET #358628

Clam Size: 5.75"W x 16.5"H x 1"D Case Pack: 12

REPLACEMENT SWABS (100-PACK) #115373

Clam Size: 5"W x 5"H x 1.5"D Case Pack: 12

INCLUDES

- Bolt raceway cleaning tool
- Chamber cleaning tool
- Nylon cleaning brush
- Small bore chamber mop
- Large bore chamber mop
- (10) bolt raceway swabs



FLIP-TOP BOTTLES (3-PACK) #197624

Clam Size: 7"W x 11"H x .75"D Case Pack: 6

INCLUDES

- 4 oz polyethylene bottles
- (1) flip-top
- (1) standard



8" PIPETTES (12-PACK) #146527

Display Size: 6"W x 10.25"H x .6"D Case Pack: 6

- All-plastic, disposable



SILICONE CLOTH #502260

Bag Size: 5"W x 8.5"H x .52"D Case Pack: 6

- Silicone will not dry out or evaporate

Actual size: 14" x 15"



SNAP CAPS

Clam Size: 3.75"W x 5.5"H x 1.25"D Case Pack: 6

SHOTGUN	2-PACK	RIFLE	10-PACK
12 gauge	#280986	.22 Rimfire Long Rifle	#831787
20 gauge	#191808		25-PACK
.410 Bore	#358983	.22 Rimfire Long Rifle	#486758
			2-PACK
REVOLVER	6-PACK	.23 Remington	#415091
.38 Spec./357 Mag	#321398	.243 Winchester	#270693
.44 Mag	#347873	.270 Winchester	#709600
.45 Colt	#612637	.308 Winchester	#134402
		.30-06 Springfield	#391320
		7.62x39mm Russian	#787336
PISTOL	5-PACK		
.32 ACP	#647663		
.380 ACP	#337377		
9mm Luger	#303958		
.40 S&W	#745435		
.45 ACP	#146331		



MAINTENANCE MATS

Glock Model 11"x 17" #110008

1911 Model 11"x 17" #558580

Clam Size: 13.25"W x 6.25"H x 1.75"D Case Pack: 6

Maintenance Mat 12"x 24" #602557

Clam Size: 15"W x 4"H x 2.4" Case Pack: 6

ALL MATS ARE
HAND WASHABLE



Battenfeld
TECHNOLOGIES, INC.

2501 LeMone Industrial Blvd. / Columbia, MO 65201
573-445-9200 / Email: sales@battenfeldtechnologies.com

Wheeler®

ENGINEERED TO FIT THE JOB

2021 NEW PRODUCTS

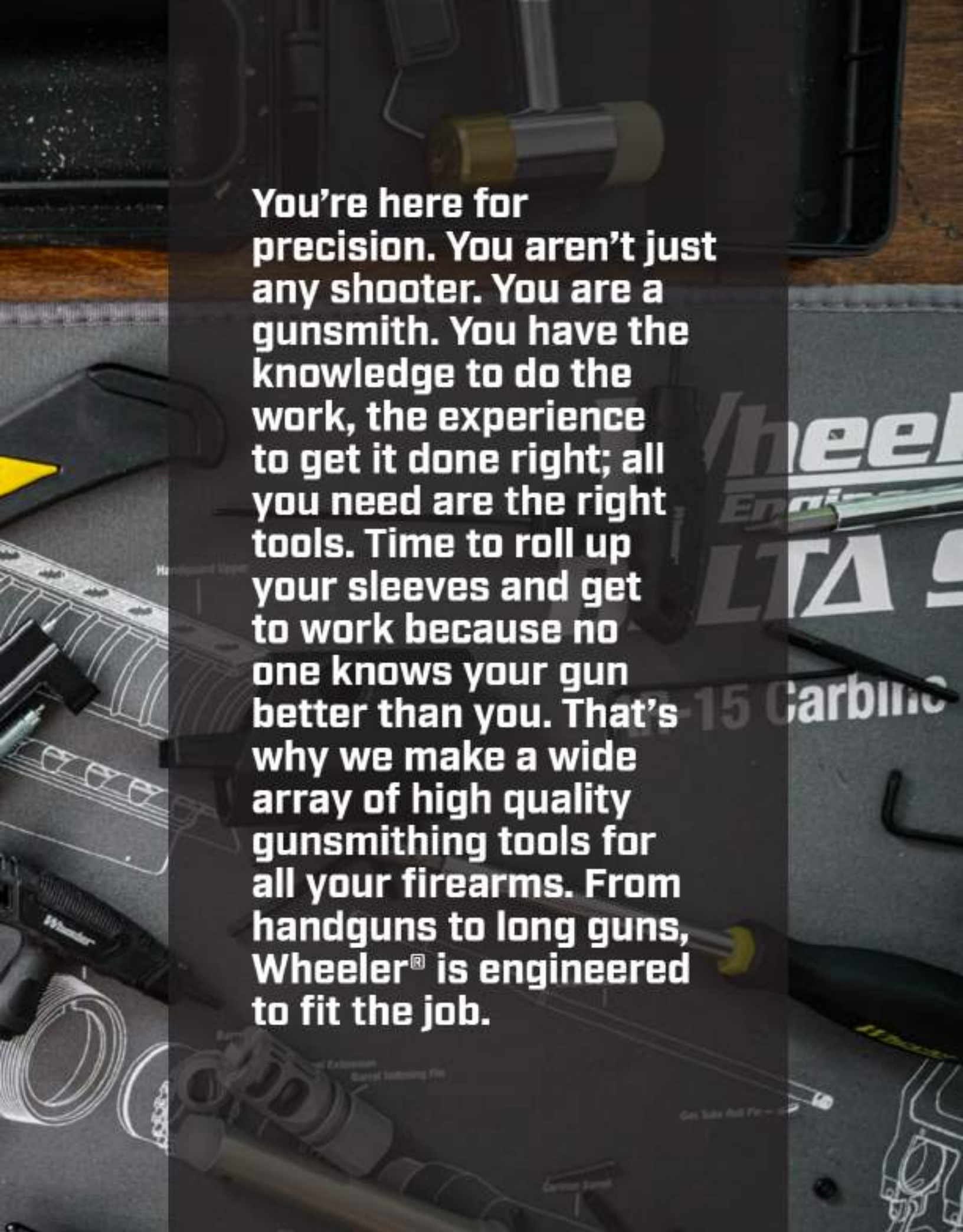

A collection of Wheeler gunsmithing tools and parts on a workbench. The tools include a hammer, a screwdriver, a hex key, and a punch. There are also various gun parts, including a barrel extension, a gas tube, and a magazine. The background is a dark, textured surface with some technical drawings and text, including "Wheeler", "LTA", and "15 Carbine".

You're here for precision. You aren't just any shooter. You are a gunsmith. You have the knowledge to do the work, the experience to get it done right; all you need are the right tools. Time to roll up your sleeves and get to work because no one knows your gun better than you. That's why we make a wide array of high quality gunsmithing tools for all your firearms. From handguns to long guns, Wheeler® is engineered to fit the job.

SPORTER BI-WEAVER® STYLE/PIC RINGS

Case Pack: 6 Box Size: TBD *Patents: www.aob.com/patents

- 6061 aluminum construction
- Proprietary reversible recoil lug for proper fit on weaver and picatinny rails
- Diagonal split reduces cross sectional area for lighter weight
- Flush clamp screws for improved ergonomics and reduced snag points

SIZES	PRODUCT #	UPC
1" Low	1133747	661120107804
1" Medium	1133748	661120107811
1" High	1133749	661120107828
30mm Low	1133750	661120107835
30mm Medium	1133751	661120107842
30mm High	1133752	661120107859
34mm Low	1133753	661120107866
34mm Medium	1133754	661120107873
34mm High	1133755	661120107880

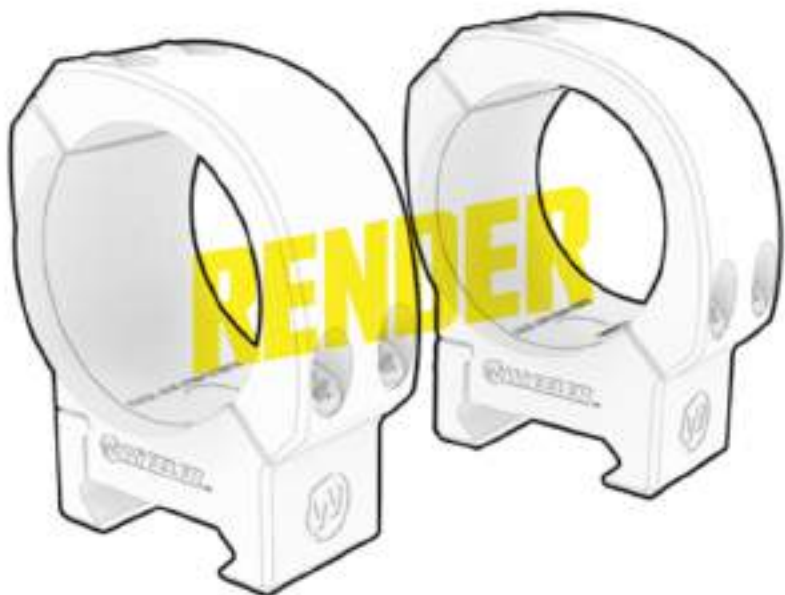

FAT STIX™ #1136022

Case Pack: 4 Box Size: TBD *Patents: www.aob.com/patents
UPC: 661120107798

- Sockets come in 15, 20, 25, 45 and 65 inch pounds for most common applications
- Popular bit sizes
- T handle design with grip and spin section
- 1/2" Socket with 1/4" drive bit
- Convenient soft carry case

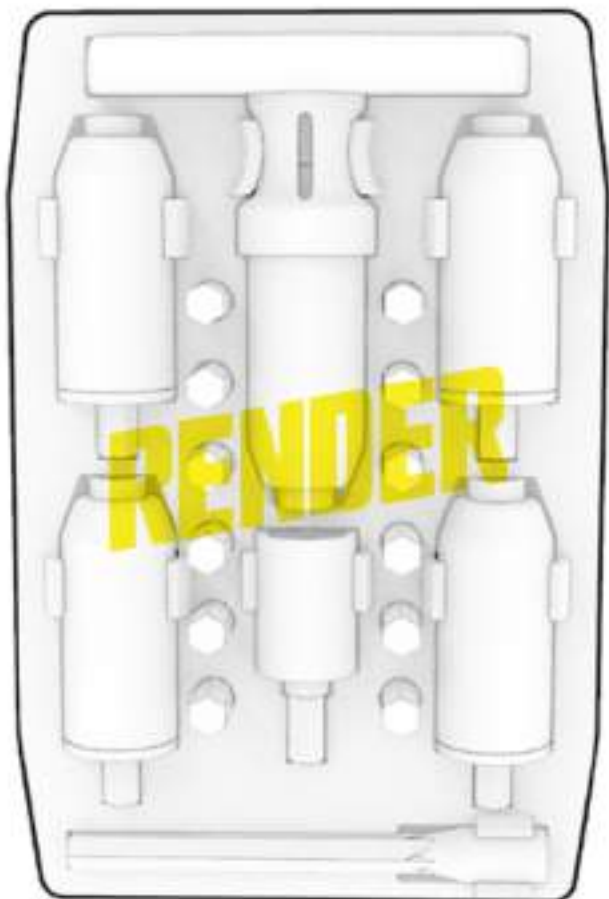

1 PIECE BOLT ACTION SCOPE MOUNTS

Case Pack: 6 Box Size: 9.41"L x 3.625"W x 2.345"D *Patents: www.aob.com/patents*

- Fits Remington Model 700 LA/SA & Savage 10/110
- 6061 aluminum construction
- 6 hole ring design
- 20 MOA elevation in base
- Flip-out anti-cant level
- Available in 1", 30mm and 34mm ring sizes

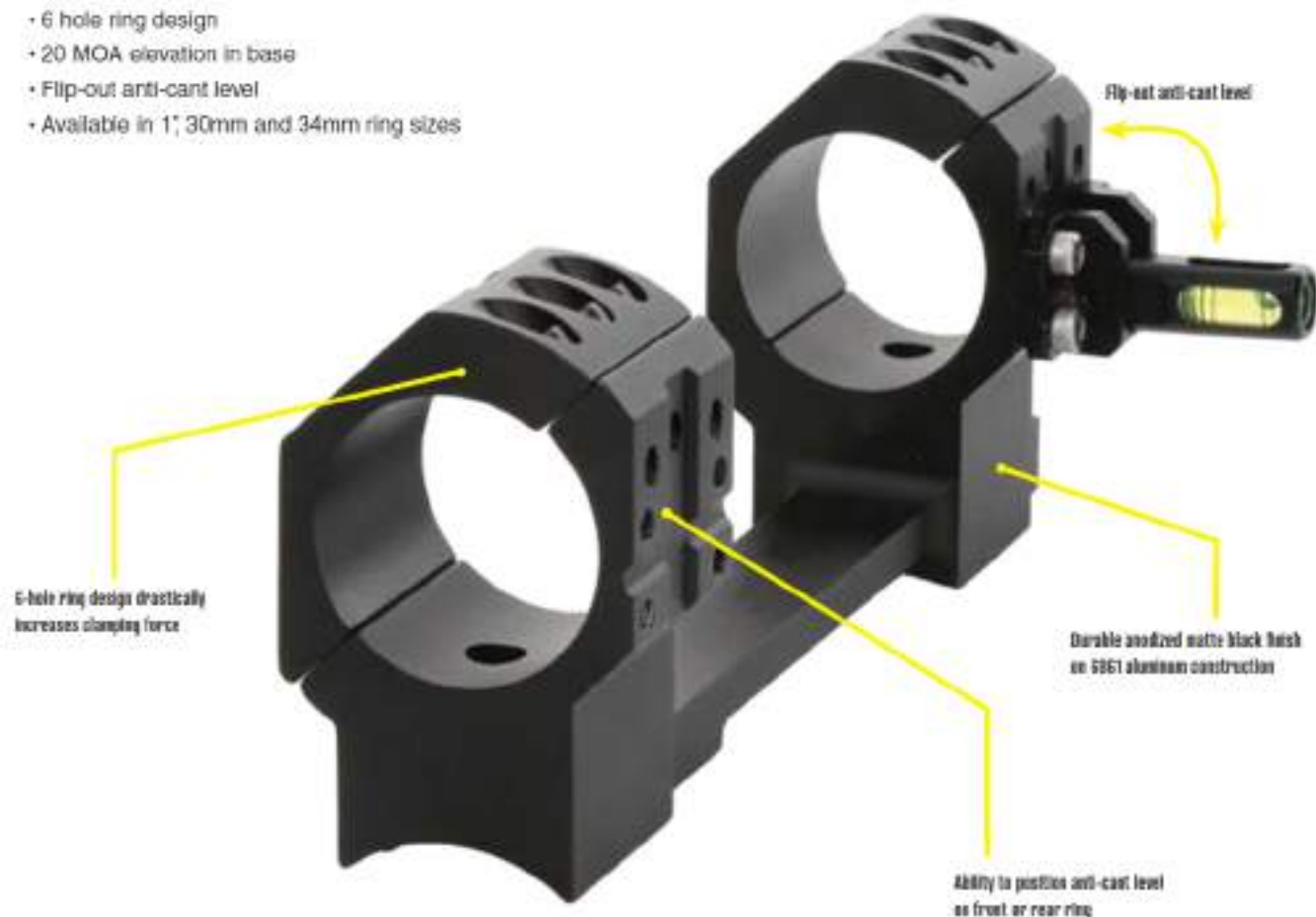

SIZES	REMINGTON® MODEL 700® LONG ACTION	REMINGTON® MODEL 700® SHORT ACTION	SAVAGE® 10 SHORT ACTION	SAVAGE® 110 LONG ACTION
1" Medium	1110071	1110068	1110074	1110077
1" High	1110072	1110069	1110075	1110078
30mm Medium	1108715	1108709	1108721	1108727
30mm High	1108716	1108710	1108722	1108728
30mm Extra High	1108717	1108711	1108723	1108729
34mm Medium	1108718	1108712	1108724	1108730
34mm High	1108719	1108713	1108725	1108731
34mm Extra High	1108720	1108714	1108726	1108732

1 PIECE CANTILEVER SCOPE MOUNT

Box Size: 3"W x 7.75"H x 2.2"D Case Pack: 5

Patents: www.aoh.com/patents

- 6061 aluminum construction
- 2" cantilever extension
- Matte black anodized finish
- Hardware included (torx screws)
- 6 hole ring design
- Retained 1/2" lock nuts secure to Pic Rail
- Integrated flip-out anti-cant level

Product	Item #
1" Scope Mount.....	#1099909
30mm Scope Mount.....	#1099953
34mm Scope Mount.....	#1100187

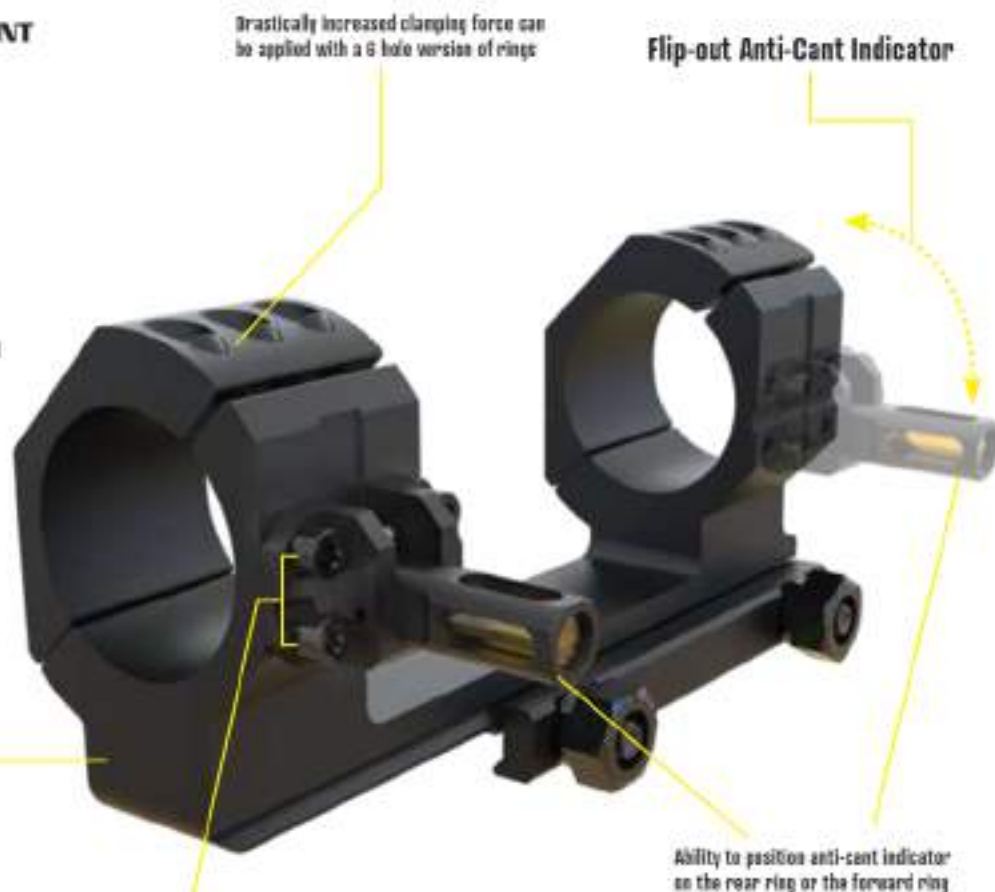

Drastically increased clamping force can be applied with a 6 hole version of rings

Flip-out Anti-Cant Indicator

Anodized matte black finish

Ability to position anti-cant indicator on the rear ring or the forward ring

Flip-out Anti-Cant Indicator is adjustable

2 PIECE PICATINNY SCOPE RINGS

Box Size: 3"W x 7.75"H x 1.1"D Case Pack: 5

Patents: www.aoh.com/patents

- 6061 aluminum construction
- Hardware included (torx screws)
- 6 hole ring design
- Retained 1/2" lock nuts secure to Pic Rail
- Integrated flip-out anti-cant level

Product #	Ring Dia.	Ring Height
#1099903.....	1"	High
#1099907.....	1"	Medium
#1099904.....	1"	Low
#1099956.....	30mm	High
#1099955.....	30mm	Medium
#1099954.....	30mm	Low
#1100186.....	34mm	High
#1099947.....	34mm	Medium
#1099951.....	34mm	Low



Drastically increased clamping force can be applied with a 6 hole version of rings

Flip-out Anti-Cant Indicator

Anodized matte black finish

Ability to position anti-cant indicator on the rear ring or the forward ring

UPPER RECEIVER AR-15 ACTION ROD #1100182

Patents: www.aob.com/patents

Clam Size: Case Pack: 4

- Eliminates stress on the upper receiver when installing a barrel
- Works on all AR-15 barrels with standard barrel extensions
- Works on forged and milled upper receivers
- No need to remove sights or optics
- Gas port index rod
- Simple twist lock design holds tool in place

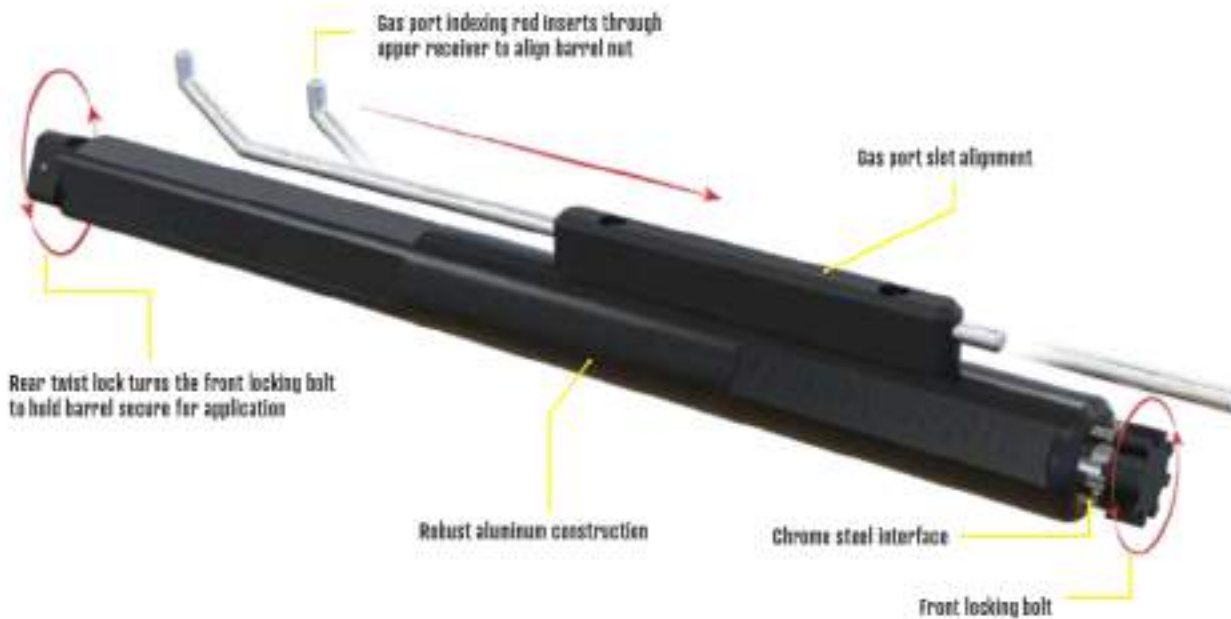

Clamp the rear of the action rod into the vise to remove stress as the upper receiver



Rod inserted into an upper receiver with the Gas port index rod protruding through to gas tube port

PROFESSIONAL ARMORER'S WRENCH #1099561

Clam Size: Case Pack: 4

- Heavy-duty steel construction
- 6 tools needed for AR builds
- Overmolded handle

REVERSE SIDE OF WRENCH



Free float handguard wrench

Castle nut wrench

1/2" torque wrench receiver

MiSpec barrel nut wrench

Heavy-duty steel construction

3/4" muzzle brake wrench

Overmolded handle

5/8" feed stock receiver wrench

Wheeler

Wheeler

MICRO MULTI-DRIVER TOOL PEN #1082257

Box Size: 9.2"W x 3.6"H x 1.7"D Case Pack: 4

- Aluminum handle construction
- Stores 5 bits internally
- Includes 17 interchangeable bits

BITS INCLUDED

- 4 - H0.9, H1.3, H1.5, H2 (Hex Metric)
- 4 - SL1.5, SL2, SL2.5, SL3 (Slotted)
- 3 - PH00, PH0, PH1 (Phillips)
- 3 - T5, T6, T7 (Torx)
- 3 - TR8, TR9, TR10 (Torx Security)



MULTI-DRIVER TOOL PEN #1082256

Box Size: 9.2"W x 3.6"H x 1.7"D Case Pack: 4

- Aluminum handle construction
- Stores 6 bits internally
- Includes 13 interchangeable bits

BITS INCLUDED

- 4 - H5/64, H3/32, H1/8, H5/32 (Hex SAE)
- 3 - SL3, SL4, SL4.5 (Slotted)
- 2 - PH1, PH2 (Phillips)
- 4 - T10, T15, T20, T25 (Torx)



AR ARMORER'S ULTRA KIT #156559 **Patents: www.aob.com/patents**

Box Size: 22"W x 10.25"H x 6.75"D Case Pack: 2

INCLUDES

- AR-15 AR armorer's vise
- AR-15 combo tool
- Torque wrench
- AR-15 bench block
- AR-15 roll pin install tool kit
- Upper vise block with gas tube alignment tool
- AR-15 maintenance mat
- Pivot & roll pin install tool
- AR front sight tool
- Delta ring tool
- Strap wrench
- AR-15 bore guide
- Adjustable receiver link
- .22 Cal bore brush
- Bolt carrier brush
- Chamber brush
- Mag/upper receiver brush
- Nylon brush handle
- Double-ended general cleaning brush
- Cleaning pick set
- Custom carry case

AR ARMORER'S PROFESSIONAL KIT #156555

Box Size: 22"W x 10.25"H x 6.75"D Case Pack: 2 **Patents: www.aob.com/patents**

INCLUDES

- AR-15 ar armorer's vise
- AR-15 combo tool
- Torque wrench
- Upper vise block with gas tube alignment tool
- AR-15 maintenance mat
- Pivot & roll pin install tool
- AR front sight tool
- Delta ring tool
- Strap wrench
- AR-15 bore guide
- Adjustable receiver link
- .22 Cal bore brush
- Bolt carrier brush
- Chamber brush
- Mag/upper receiver brush
- Nylon brush handle
- Double-ended general cleaning brush
- Cleaning pick set
- Custom carry case



AR ARMORER'S ESSENTIALS KIT #156111 **Patents: www.aob.com/patents**

Box Size: 21"W x 7.25"H x 3.5"D Case Pack: 2

INCLUDES

- AR-15 combo tool
- Torque wrench
- Upper vise block with gas tube alignment tool
- Pivot & roll pin install tool
- AR-15 maintenance mat
- AR-15 mag well vise block
- AR-15 adjustable receiver link
- Custom carry case



AR-15 MAINTENANCE MAT #156824

Clam Size: 5.5"W x 22.75"H x 3.5"D Case Pack: 4

- 47" x 20" of work space
- Made of robust padded neoprene
- Absorbs oils and solvents
- Non-slip rubber backing
- Rolls up for easy storage
- Hand washable



AR ARMORER'S VISE #156224

*Patents: www.aab.com/patents

Box Size: 21.25"W x 7.75"H x 6"D Case Pack: 2

- Non-slip rubber foot can be removed for permanent benchtop mounting
- Forend Support can accommodate diameters up to 2.3"
- Base is constructed of rigid steel with depressions to contain spare parts or tools
- Front and rear supports rotate to multiple positions and are reversible for maximum customization

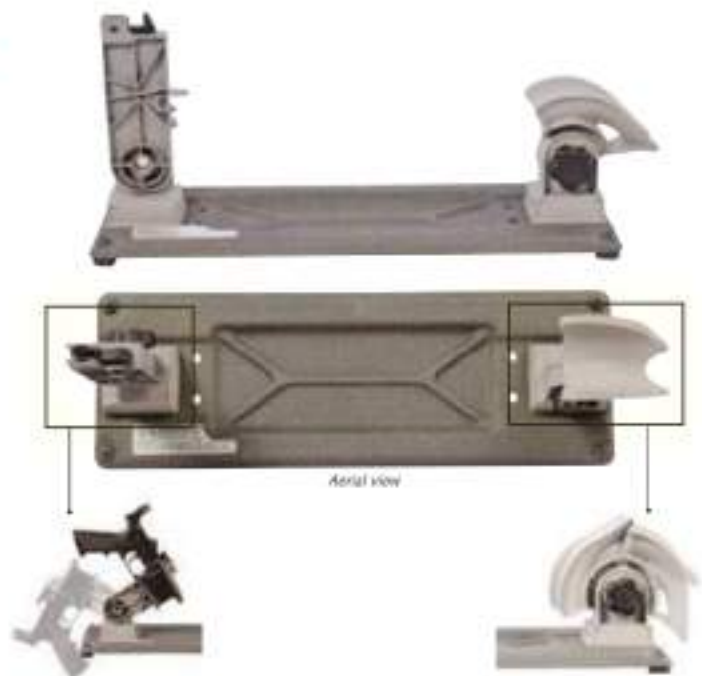

MAG WELL VISE BLOCK

*Patents: www.aab.com/patents

AR-15 #156211

AR LR/10 Variant #146200

Clam Size: 8"W x 13"H x 2.5"D Case Pack: 4

- Mountable to benchtop with included fasteners
- Locks into place using magazine lock-on receiver
- Built-in hammer stop prevents damage to lower receiver
- Solvent-resistant polymer provides durability and is non-marring to surfaces
- Mag Well arm is removable for clamping in a vise



AR LR/10 Variant has a larger mag well insert to accommodate a larger platform and is compatible with SR25 type lowers: DPMS® LR308, KAC® SR25, LWRCI REPR®, LaRue OBR®, Bushmaster® .308 ORC®, LMT® .308 MWS, Remington® R-25, POR® P-308, JP Enterprises® LRP-07, Les Baer® .308, Colt® LE901-16S and The Armalite® AR-10A.

AR CARBON MULTI-SCRAPER #1078195

Clam Size: 4"W x 8.2"H x 0.75"D Case Pack: 4

- Cleans (11) surfaces of the Bolt Carrier Group
- Fits inside AR pistol grips



COMPACT AR MULTI-TOOL #1078948

Clam Size: 5"W x 7"H x 2"D Case Pack: 4

- Fits compact into nylon belt sheath
- Multi-tool design to perform many different functions in the field
- Satin finish, stainless steel construction

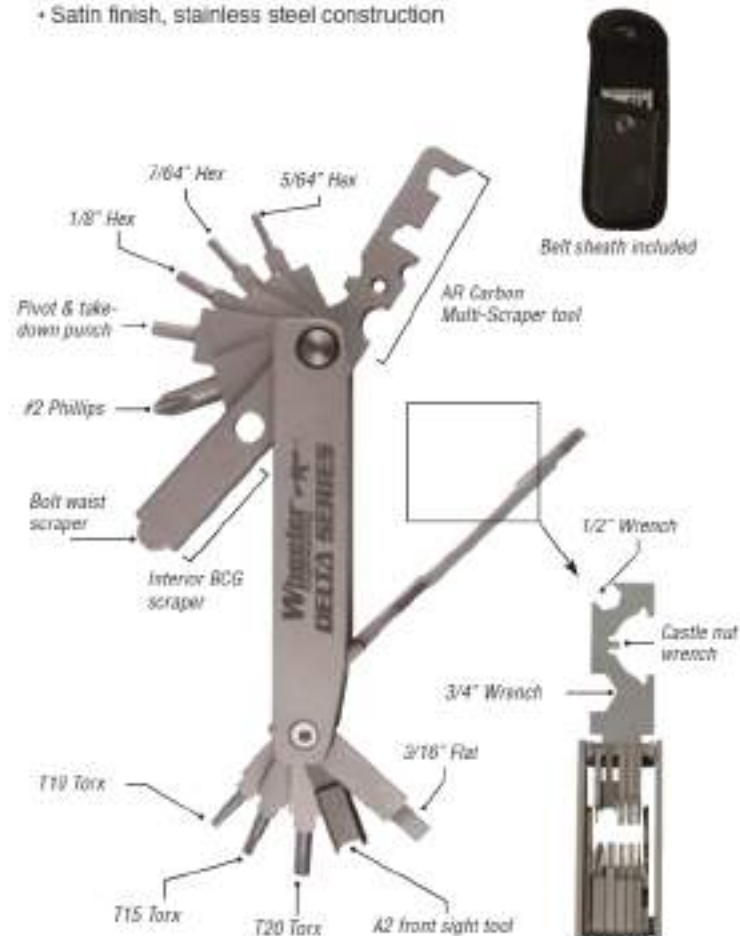

BORE GUIDES

AR-15#156213

AR LR/10 Variant#156777

300 AAC Blackout#777209

Clam Size: 4"W x 1.5"H x 1.5"D Case Pack: 4

- Precision CNC machined aluminum
- Durable anodized finish

These Wheeler® Delta Series® Bore Guides fit securely in any AR-15 or AR LR/10 variant upper and can be retained in place by closing the dust cover on the upper—engaging a groove in the guide. The AR-15 Bore Guide works well with .223 and .204, while the AR LR/10 Variant works well on .308. The AR-15 300 AAC Blackout Bore Guide works on any 30 caliber, 6.5 or 6.8 AR-15. The AR-15 Bore Guide inner tube diameter is .250".

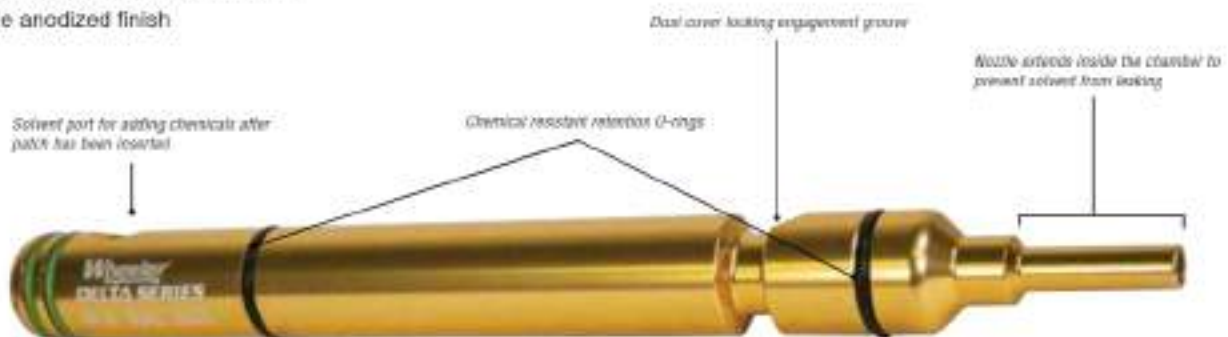

A. AR COMBO TOOL ONLY #156999

Clam Size: 5"W x 15.2"H x 2"D Case Pack: 4



B. AR COMBO TOOL WITH TORQUE WRENCH #156700

Clam Size: 7.5"W x 21"H x 2.5"D Case Pack: 4

AR TRIGGER GUARD INSTALL TOOL #710907

Clam Size: 5"W x 6.7"H x 1"D Case Pack: 4

- Install or change trigger guards quickly and easily
- Includes install pin and an uninstall pin
- Pins conveniently store in the frame
- Made of durable aluminum with a MI-spec anodized surface finish

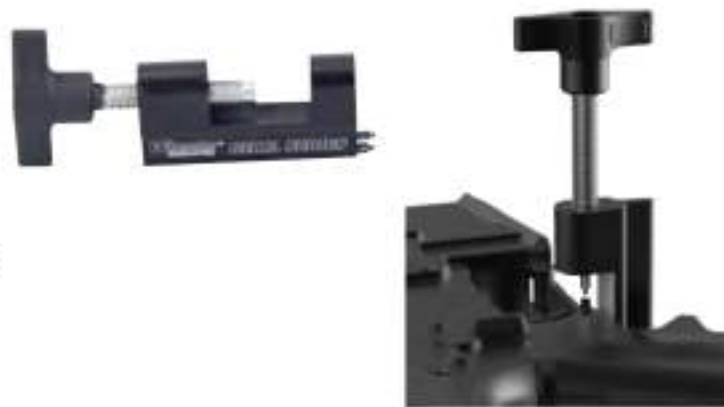

AR BOLT CATCH INSTALL PUNCH KIT #710906

Clam Size: 3.25"W x 9.4"H x 0.5"D Case Pack: 4

- Flat on one side for proper alignment
- Rubber overmold to prevent damage to firearm
- Includes (2) steel punches
 - (1) with counter-bored tips to start roll pins
 - (1) with indexing tips to finish roll pins
- Made of durable aluminum with a MI-spec anodized finish



AR-15 ROLL PIN INSTALL TOOL KIT #952636

Clam Size: 3.6"W x 9"H x 1.75"D Case Pack: 4

INCLUDES

- AR Bolt Catch Install Punch Kit
- AR Trigger Guard Install Tool
- (3) starter steel punches (1/16", 5/16", 3/32")
- (3) driver steel punches (1/16", 5/16", 3/32")
- Two-sided hammer
- Blow-molded storage case



AR ARMORER'S BENCH BLOCK #156945

Clam Size: 6.25"W x 10.4"H x 1.25"D Case Pack: 4

- Durable, non-marring urethane material to protect gun finish
- Designed to assist in all aspects of an AR-15 build
- Ideal for changing or adjusting triggers



AR FRONT SIGHT TOOL #156437

Clam Size: 5.25"W x 4"H x 1.5"D Case Pack: 4

- Compatible with any 1/4" hex driver
- Key ring handle
- Black zinc-plated steel



AR HANDGUARD TOOL #567839

Clam Size: 4"W x 15"H x 1.5"D Case Pack: 4

- Durable, nylon-reinforced 24" x 3/4" rubber strap
- Non-marring
- Rubberized no-slip grips
- Easily adjustable



AR DELTA RING TOOL #209943

Clam Size: 4.75"W x 16.5"H x 1.5"D Case Pack: 4

- Easily remove mil-spec AR-15 and M16 handguards
- Durable 100% vinyl-coating protects gun's finish
- Steel bracket welded for durability, even with stuck or broken Delta Rings



AR PIVOT & ROLL PIN INSTALL TOOL #156243

Clam Size: 5.25"W x 4"H x 1.5"D Case Pack: 4

- For the AR-15, M4, or M16
- Fast and effortless pivot spring and detent work
- Roll Pin Punch and starter for all lower receiver roll pins
- Handy key ring for storage
- Black electro-coated steel



PIC RAIL RISERS

0.5"#156506

- Lightweight and durable CNC machined aluminum construction
- Each riser is 5.75" in length and incorporates (3) T15 fasteners for maximum mounting strength
- Allow perfect height alignment for optics and accessories
- (2) sets of fasteners included



AR UPPER VISE BLOCK #156444

Clam Size: 7"W x 15"H x 2"D Case Pack: 4

- Fits left- and right-hand Mil-spec A2 upper with carrier handles*
- Fits flat top receivers
- Made of high-pressure, solvent-resistant polymer material

**Other AR-15 variants may be adapted with special attention to potentially non-conforming surfaces or features. Does NOT work with left-handed uppers that have a dust cover that flips upward.*



AR UPPER/PIC RAIL VISE BLOCK #156888

Clam Size: 7"W x 14.5"H x 1.75"D Case Pack: 4

- Multi-function design holds AR-15 and most AR LR/10 uppers
- Easily secure any pic rail receiver
- Durable extruded and machined aluminum construction



AR-15 COMPLETE BRUSH SET #156715

Clam Size: 5.5"W x 13.75"H x 1.5"D Case Pack: 4

INCLUDES

- Magazine/Upper Receiver Brush with Magazine Take Down Tool
- Bolt Carrier Brush with 8-32 threads
- Chamber Brush with 8-32 threads
- .22 Cal Bore Brush with 8-32 threads



AR GAS BLOCK TAPER PIN REMOVAL TOOL #1079808

Clam Size: 5.75"W x 8.3"H x 2.25"D Case Pack: 4

- Works on A2 front sights
- Works on Smith & Wesson® single-taper pin gas blocks
- Works on dual taper pins
- Durable tool steel

Finishing punch

Starter punch



AR LR/10 VARIANT RECEIVER LAPPING TOOL #1082227

Clam Size: 4.5"W x 11.5"H x 1.25"D Case Pack: 4

AR-15 RECEIVER LAPPING TOOL #156757

Clam Size: 4.5"W x 11.5"H x 1.25"D Case Pack: 4

- Compatible with battery-powered or electric drill
- Steel construction with a black oxide finish

INCLUDES

- Flex driver shaft
- 220 Grit lapping compound
- Steel lapping bar



Lapping a receiver ensures a perfectly square and true surface for the barrel to mate against, enhancing accuracy. Also, honing the surface can produce optimal positioning of barrel nut so ideal torque can be achieved along with proper gas tube hole alignment.

GOOD LAP

BAD LAP



COMPACT AR CLEANING KIT #1082251

Box Size: 3.25"W x 7.5"H x 1.75"D Case Pack: 6

- For use on .22 or .30 caliber rifles
- Semi-rigid carry case fits into an AR magazine pouch
- Collapsible cleaning rod with rotating T-handle
- Stainless steel cleaning rod

INCLUDES

- AR chamber brush
- Multi-function bolt scraper tool
- Cleaning pick
- Nylon cleaning brush
- Collapsible 36" stainless steel cleaning rod with rotating T-handle
- (3) Star Chamber Cleaning Pads
- Patches for .22 or .30 cal
- Nylon brushes for .22 or .30 cal
- Jags for .22 or .30 cal



OUR HOLLOW-GROUND PERFECT-FIT BITS Standard shape bits cam out of a screw's slot and can gouge or mar the screw head. Hollow-Ground bits gently carve at the tip spreading force equally along the sides of the screw slot damage free.



DELUXE 89-PIECE SET #562194

Box Size: 8.3"W x 12.3"H x 3.1"D Case Pack: 10

*Patents: www.aab.com/patents

INCLUDES

- (54) Hollow-Ground flat bits
- (15) Specialty bits
- Durable S2 tool steel
- (2) No-slip overmolded handles
- 2 1/4" shaft extension
- Hex-to-square drive adapter
- Convenient hinged storage case



BASIC 72-PIECE SET #776737

Box Size: 8.3"W x 12.3"H x 3.1"D Case Pack: 10

*Patents: www.aab.com/patents

INCLUDES

- (54) Hollow-Ground flat bits
- Durable S2 tool steel
- (2) No-slip overmolded handles
- Convenient hinged storage case



43-PIECE SET #954621

Box Size: 9.25"W x 8.5"H x 3"D Case Pack: 4

*Patents: www.aab.com/patents

INCLUDES

- (21) Hollow-Ground flat bits
- Durable S2 tool steel
- Durable no-slip overmolded handle
- Magnetic bit retention in driver
- Convenient hinged storage case



55-PIECE HEX/TORX SET #1081958

Box Size: 5.6"W x 7.8"H x 2.3"D Case Pack: 4

INCLUDES

- (50) Hollow-Ground flat bits
- 1/4" Driver Handle
- 4mm Driver Handle

SAE Hex	Metric Hex	Torx	Phillips
.028" 9/64"	.7mm 4.5mm	T1 TT10	#1
.035" 5/32"	.9mm 5mm	T2 TT15	#2
.05" 3/16"	1.3mm 5.5mm	T3 TT20	Flat
1/16" 7/32"	1.5mm 6mm	T4 TT25	#14
5/64" 1/4"	2mm 7mm	TT5 TT30	#32
3/32" 5/16"	2.5mm 8mm	TT6 TT35	
7/64" 3/8"	3mm 10mm	TT7 TT40	
1/8"	4mm	TT8 TT45	
		TT9 TT50	



SPACE SAVER GUNSMITHING SET #664507

Clam Size: 8"W x 9"H x 1.5"D Case Pack: 10

INCLUDES

- (26) Bits
- Standard, Phillips, hex, and torx bits
- (1) 2" long #2 Phillips bit, ideal for recoil pad installation
- (1) Hex-to-square conversion bit
- (1) Comfortable, overmolded plastic, magnetic handle



PRECISION MICRO SET #564018

Clam Size: 5.25"W x 11.5"H x 1"D Case Pack: 4

- 58-piece set
- Chrome plated steel bits
- Extendible Handle from 3 3/4"-5 1/2"
- 5 3/4" flexible extension shaft
- Precision-formed bits for fastener engagement
- Individual bit markings
- Organized carry/storage case



21-PIECE EXPANSION SET #954671

Clam Size: 2.75"W x 9"H x 2"D Case Pack: 4

- Durable S2 tool steel
- Plastic storage tray that fits 72 or 89-piece sets
- 1/2" x 1/4" socket driver
- 2.5mm, 3mm, 3.5mm, 4mm, 4.5mm, 5mm, 5.5mm, 6mm, 7mm and 8mm Hex Bits
- T6, T7, T8, T9, T10, T15, T20, T27, T30 Torx Bit



17-PIECE UPGRADE SET #748555

Clam Size: 2.75"W x 9"H x 2"D Case Pack: 1

INCLUDES

- (15) Specialty bits
- Shaft extension
- Square-to-hex adapter



30-PIECE P-HANDLE DRIVER SET [SAE/METRIC HEX & TORX] #1081957

Box Size: 15"W x 8.6"H x 6.7" Case Pack: 4

Molded stand can sit on benchtop or has mounting holes on back for hanging

SAE Hex	Metric Hex	Torx
3/32"	1.5mm	T7
7/64"	ball, 2mm	T8
ball, 1/8"	ball, 2.5mm	T9
ball, 9/64"	ball, 3mm	T10
ball, 5/32"	ball, 4mm	T15
ball, 3/16"	ball, 5mm	T20
ball, 7/32"	ball, 6mm	T25
ball, 1/4"	ball, 7mm	T27
ball, 5/16"	ball, 8mm	T30
ball, 3/8"	ball, 10mm	T40



45-PIECE KEY SET [SAE/METRIC HEX & TORX] #1081959

Hanging Size: 6"W x 11.5"H x 2"D Case Pack: 4

SAE Hex	Metric Hex	Torx
.028" 9/64"	.7mm 4.5mm	T1 T9
.035" 5/32"	.9mm 5mm	T2 T10
.05" 3/16"	1.3mm 5.5mm	T3 T15
1/16" 7/32"	1.5mm 6mm	T4 T20
5/64" 1/4"	2mm 7mm	T5 T25
3/32" 5/16"	2.5mm 8mm	T6 T30
7/64" 3/8"	3mm 10mm	T7 T35
1/8"	4mm	T8



LEVEL-LEVEL-LEVEL #113088

Clam Size: 4"W x 7.5"H x 0.5"D Case Pack: 4

*Patents: www.aab.com/patents



Scope Turret Level
(not magnetized)

Action Level
(magnetized)



ANTI-CANT INDICATORS

A. 1"#755712

B. 30mm#766112

C. Pic Rail...#580033

Clam Size: 5.4"W x 7"H x 1"D Case Pack: 4

- Indicates precise, repeatable level gun position
- Easy-to-view from shooting position
- Attaches to scope, folds in when not in use
- Universal pic rail attachment
- Precision machined aluminum with anodized finish



PROFESSIONAL RETICLE LEVELING SYSTEM #119050

Clam Size: 11.25"W x 9.25"H x 3.35"D Case Pack: 4

- Precision machined aluminum with anodized finish
- Barrel clamp level has non-marring pads
- Adjustable barrel clamp level fits around even the largest diameter barrels, including shotguns
- Each level has an integrated bubble level for precise measurement
- Reference level has magnetic bottom for stability

INCLUDES

- (2) calibrated machined aluminum level housings
- Foam-molded storage case



Reference Level



Barrel Clamp Level

PROFESSIONAL LASER BORE SIGHTER

Red Laser #580022

Green Laser #589922

Clam Size: 6"W x 11"H x 2"D Case Pack: 4

- Machined aluminum body with soft rubber overmolding
- Hand-tuned during manufacturing
- Laser module permanently secured for reliable performance

INCLUDES

- Plastic storage case
- Lithium 123A battery
- Reflective sighting grid



ULTRA SCOPE MOUNTING KIT #541010

*Patents: www.aabi.com/patents

Box Size: 11.25"W x 9.25"H x 3.35"D Case Pack: 2

Professional Reticle Leveling System ensures scope is level and crosshairs are perfectly perpendicular

INCLUDES

- F.A.T. Wrench®
- (9) bits
- (1) socket
- Bit holder
- Thread lockers
- Lens pen to keep scope clean
- Heavy-duty storage case with foam-molded inserts



F.A.T. WRENCH® #553556

Clam Size: 6.7"W x 8.4"H x 3"D Case Pack: 4

- Bits are made from S2 tool steel and hardened to 56-58 Rockwell "C"
- Torque adjustment range from 10 in/lbs. to 65 in/lbs.
- Accuracy plus/minus 2 inch/pounds up to 40 in/lbs.; 40-65 is +/- 5%



NEW ERGONOMIC DESIGN!



DIGITAL F.A.T. WRENCH® #710909

Clam Size: 7.75"W x 9.75"H x 3"D Case Pack: 4

- Bits are made from S2 tool steel and hardened to 56-58 Rockwell "C"
- Ergonomic overmolded design
- 15-100 in/lb. range and measure in lb-in, kg-cm, N-m
- +/- 2% accuracy
- Audible and visual indicator
- Full set of bits included
- Low battery indicator



ARMORER'S HANDGUN SIGHT TOOL #710905

Box Size: 8.5"W x 5"H x 5.25"D Case Pack: 4

- Fully captures and supports slide
- Sight prong is reversible to accommodate Glock's
- Works on all semi-auto pistols
- Large 4-post drive knob to easily push the sight



SCOPE RING ALIGNMENT AND LAPPING KITS

1" Rings #204061

30mm Rings #633266

34mm Rings #1081035

1"/30mm Combo Kit #305172

Lapping Compound Kit #342303

(1 each; 220, 320 and 600 grit compound)

1" Scope Ring Alignment Bar #781366

Case Pack: 1

INCLUDES

- Lapping bar(s)
- Alignment bar
- Lapping bar handle
- 220 Grit lapping bar compound



SCOPE MOUNTING KITS

Professional Scope Mounting Kit 1" #540127

Professional Scope Mounting Kit Combo #545454

(1" and 30mm alignment and lapping bars) Case Pack: 4

Storage Case #1017566

Case Pack: 1

INCLUDES

- | | | |
|---------------------|------------------|----------------------|
| • F.A.T. Wrench® | • Flex driver | • Lapping bar handle |
| • (10) bits | • Lapping bar(s) | • Lapping compound |
| • 1/2" socket | • Alignment bar | • Thread locker |
| • Level-Level-Level | | • Storage case |



PROFESSIONAL DIGITAL TRIGGER GAUGE #710904

Box Size: 6"W x 8.75"H x 1.75"D Case Pack: 5 *Patents: www.aab.com/patents*

- 0-12 lbs. range
- +/- .2% accuracy
- Load sensor directly contacts the trigger
- Feature max, min, average and live functions
- Audible indicator tone
- Low battery indicator
- Arm folds inside housing to protect the load sensor when not in use
- Includes bladed trigger adapter to allow use with triggers that have internal safety blades
- Foam lined storage case



MEASURES IN
POUNDS & KILOGRAMS

TRIGGER PULL SCALE #309888

Clam Size: 4.5"W x 14.75"H x 1.25"D Case Pack: 4

- Measures in 2 oz increments
- Accurate to +/- 2 oz
- Easy-to-read sliding indicator
- Range from 8 oz-8 lbs



PROFESSIONAL FILE SET #710908

Box Size: 17"W x 4"H x 2.75"D Case Pack: 4

INCLUDES

- 8" half round file
- 8" flat file
- 6" square file
- 6" triangle file
- 6" round file
- 4-in-1 Rasp
- File cleaning brush
- Extra-fine diamond plate
- Stick of file chalk
- Flat coarse grit
- Round coarse grit
- Triangle coarse grit
- Flat medium grit
- Round medium grit
- Triangle medium grit
- Flat fine grit
- Round fine grit
- Triangle fine grit



UNIVERSAL 1911/PISTOL BENCH BLOCK #672215

Clam Size: 5"W x 9.25"H x 1.5"D Case Pack: 5

- Made of non-marring urethane
- Main spring removal recess
- Barrel link removal V channel
- Rear sight drift channel/ front sight staking channel
- Hammer and sear pin removal holes
- Ejector port dressing channel
- Rail dressing round bottom channel
- Perfect for M1911 pistols and 10/22s



Dimensions: 1 1/4"H x 4"Diameter

UNIVERSAL BARREL CLAMP #672286

Clam Size: 5"W x 9.25"H x 3"D Case Pack: 5

- Precision extruded from aircraft-grade aluminum
- Bonded with non-marring urethane
- (3) barrel openings: .85", .66", .53"



CERAMA-COAT™ CUSTOM GUN ARMOR

CERAMA-COAT™ CUSTOM GUN ARMOR

Black Cerama-Coat™..... #468993

Flat Dark Earth Cerama-Coat™..... #492304

Olive Drab Cerama-Coat™..... #567312

Clam Size: 4.75"W x 8.5"H x 3"D Case Pack: 4

- Highly resistant to scratching, chipping and gun solvents
- Weatherproof, matte finish
- Bonds to ferrous metals, alloys, stainless steel and other synthetics that can be heated to 200° F
- 4 oz cans



Black

Flat Dark Earth

Olive Drab

NYLON/BRASS HAMMER #711016

Clam Size: 2.6"W x 9.3"H x 1"D Case Pack: 5

- Nylon face is non-marring
- Brass face can be used for driving pins and punches
- 11" length



MASTER ROLL PIN PUNCH SET #110128

Box Size: 5.75"W x 9"H x 2"D Case Pack: 4

- Machined and hardened steel
- Starter pins designed with a counter-bored tip
- Roll pins designed with a ball profile tip
- Knurled pin handles for secure handling
- Non-marring nylon hammer head

INCLUDES

- 5/16"
- 1/4"
- 7/32"
- 3/16"
- 5/32"
- 1/8"
- 3/32"
- 5/64"
- 1/16"



MASTER INTERCHANGEABLE HAMMER SET #110268

Box Size: 3.5"W x 11.5"H x 2.5"D Case Pack: 4

INCLUDES

- (2) machined metal hammer bodies
- (4) hammer faces with each hammer body: metal, brass, nylon, rubber
- Durable blow-molded case



HAMMER PUNCH SET #951900

Box Size: 5.25"W x 11"H x 1.75"D Case Pack: 1

INCLUDES

- Polymer/brass combination hammer
- (8) precision brass punches
- (4) steel punches
- (2) plastic punches
- Handy molded case



BRASS PUNCH SET #780194

Clam Size: 8.75"W x 5.6"H x 5"D Case Pack: 1

- Made of solid machined metal
- Reduces the chance of marring
- (8) precision crafted pin punches
- Handy roll-up pouch



ROLL PIN STARTER SET #710910

Clam Size: 8"W x 10.75"H x 1"D Case Pack: 4

- Machined from hardened steel
- Designed to provide proper alignment of the roll pin and to prevent damage to firearm
- Identified slots in roll-up nylon pouch
- 5/16", 1/4", 7/32", 3/16", 5/32", 1/8", 3/32", 5/64", 1/16"



ROLL PIN PUNCH SET #204513

Clam Size: 8"W x 10.75"H x 1"D Case Pack: 4

- Machined from hardened steel
- Designed to provide proper alignment of the roll pin and to prevent damage to firearm
- Identified slots in roll-up nylon pouch
- 5/16", 1/4", 7/32", 3/16", 5/32", 1/8", 3/32", 5/64", 1/16"



Action Wrench #1 #808771

(Mausers with flat-bottomed receivers) **Case Pack:** 1

Action Wrench #2 #414521

(Remington® 700) **Case Pack:** 1

Savage® Barrel Nut Wrench #123038

Case Pack: 4

Barrel Vise with 3 Oak Bushing #465185

Case Pack: 1

Lead Barrel Vise Shims (4-pack) #239444

Case Pack: 1

- 15" x 1" diameter steel handle
- Double-ended Savage® Barrel Nut Wrench fits early and late model nuts on the 110 and 10 series rifles
- (2) ½" square drive holes for swing bar or torque wrench
- Barrel Vise includes (2) pre-drilled oak blocks (1" and ¾") and solid block for custom drilling



BEDROCK™ GLASS BEDDING KIT #190274

Box Size: 4.5"W x 9"H x 2"D **Case Pack:** 4

- 4 oz Bedrock™ (2 oz resin, 2 oz hardener)
- Brown and Black dye for wood or synthetic gunstocks
- Release gent (plus 2 applicators)
- 2 fl oz micro balloons
- Modeling clay
- Surgical Tubing
- (3) Mixing cups
- (3) Mixing/applicator sticks
- Illustrated instruction booklet



MAGNIFYING VISOR #639552

Box Size: 7.2"W x 2.7"H x 8"D **Case Pack:** 1

- 1.8x and 2.3x magnification levels
- Accessory loupe for really close inspection
- Adjustable, padded head strap



RECOIL PAD INSTALLATION FIXTURE #184528

Box Size: 5.5"W x 2.3"H x 2.4"D **Case Pack:** 1

- Transfers toe-line angle and comb line from the stock to new recoil pad
- Serves as a stable work-holding fixture for off-the-stock sanding of the pad
- Designed for use with any table-mounted belt or disc sander





CRIMSON TRACE



FAILURE 
IS NOT AN OPTION

2021 NEW PRODUCTS



For more than 25 years, Crimson Trace has been an industry leader in aiming solutions. Through user-innovation and patented products, CT has pushed the envelope to create best-in-class gear for our Advocates. Those shooters who have an obsession for best-in-class Coveted Gear.

"Courage is fear holding on a minute longer." - George S. Patton

*"All that is needed for evil to flourish
is for a good man to do nothing." - J.F.K.*

*"I am a sheepdog, I live to protect the
flock and confront the wolf."*

- Lt. Col. David Grossman

*"I have a very strict gun control policy: if there's
a gun around, I want to be in control of it." - Clint Eastwood*

*"To hunt successfully, you must know your
ground, your pack and your quarry." - K.J. Parker*

*"Tell me and I forget, teach me and I may remember,
involve me and I learn." - Benjamin Franklin*

"If you ain't first you're last." - Ricky Bobby

**FOR SWAGGER,
FROM BACKYARD TO BATTLEFIELD
CRIMSON TRACE IS THE ONLY
AIMING SOLUTIONS BRAND
THAT GUARANTEES SUCCESS.**

*"I will never quit. I persevere and thrive on adversity...
IF knocked down, I will get back up, every time." - U.S. Navy Seals*

**BECAUSE FAILURE
IS NOT AN OPTION.**

RIMFIRE 3-9x40mm

01-01580 UPC - 810048570034 Case Pack 1
 Box Dimensions: 13.5" l x 4" w x 3.5" h

- > Optimized hunting optic
- > Dedicated rimfire reticle
- > Fully multi-coated lens for maximum clarity
- > Second focal plane
- > Aerospace-grade 1" maintube
- > Generous 4" eye relief
- > Spring-loaded zero-reset capped turrets
- > Waterproof, shockproof, and nitrogen-purged
- > Lightweight aluminum construction, 14.1 oz.
- > Lifetime Warranty



CT CUSTOM BDC RIMFIRE RETICLE



TRACE

BALLISTIC CALCULATOR
WWW.CRIMSONTRACE.COM

Get the precise bullet drops for your ammunition and atmospheric conditions using the FREE Crimson Trace Ballistic Calculator.

The Crimson Trace® Brushline™ dedicated hunting optics have been purposefully built from the ground up. The line features aerospace-grade 1" and 30mm maintubes that are lightweight, durable, and reliable. They are nitrogen-purged, waterproof, shockproof, and they are fully multi-coated in our MOC coatings. All Brushline™ scopes are covered by our Crimson Trace® LIFETIME WARRANTY and are backed by our award-winning customer service team.

3-9x40mm

01-01550 UPC - 810048570003 Case Pack 1
 Box Dimensions: 13.5" l x 4" w x 3.5" h

- > Optimized hunting optic
- > Diamond-pattern BDC reticle
- > Second focal plane
- > Aerospace-grade 1" maintube
- > Fully multi-coated lens for maximum clarity
- > Generous 4" eye relief
- > Spring-loaded zero-reset capped turrets
- > Waterproof, shockproof, and nitrogen purged
- > Lightweight aluminum construction, 16.2 oz.
- > CT Lifetime Warranty



CT CUSTOM BDC RETICLE



TRACE

BALLISTIC CALCULATOR
WWW.CRIMSONTRACE.COM

Get the precise bullet drops for your ammunition and atmospheric conditions using the FREE Crimson Trace Ballistic Calculator.

The Crimson Trace® Brushline™ dedicated hunting optics have been purposefully built from the ground up. The line features aerospace-grade 1" and 30mm maintubes that are lightweight, durable, and reliable. They are nitrogen-purged, waterproof, shockproof, and they are fully multi-coated in our MOC coatings. All Brushline™ scopes are covered by our Crimson Trace® LIFETIME WARRANTY and are backed by our award-winning customer service team.

RIMFIRE 4-12x40mm

01-01590 UPC - 810048570041 Case Pack 1
 Box Dimensions: 17.5" l x 4.5" w x 4" h

- > Optimized hunting optic
- > Dedicated rimfire reticle
- > Second focal plane
- > Aerospace-grade 1" maintube
- > Fully multi-coated lens for maximum clarity
- > Generous 4" eye relief
- > Spring-loaded zero-reset capped turrets
- > Waterproof, shockproof, and nitrogen purged
- > Lightweight aluminum construction, 16.2 oz.
- > CT Lifetime Warranty



CT CUSTOM BDC RIMFIRE RETICLE



Get the precise bullet drops for your ammunition and atmospheric conditions using the FREE Crimson Trace Ballistic Calculator.

The Crimson Trace® Brushline™ dedicated hunting optics have been purposefully built from the ground up. The line features aerospace-grade 1" and 30mm maintubes that are lightweight, durable, and reliable. They are nitrogen-purged, waterproof, shockproof, and they are fully multi-coated in our MOC coatings. All Brushline™ scopes are covered by our Crimson Trace® LIFETIME WARRANTY and are backed by our award-winning customer service team.

4-12x40mm

01-01560 UPC - 810048570010 Case Pack 1
 Box Dimensions: 17.5" l x 4.5" w x 4" h

- > Optimized hunting optic
- > Diamond-pattern BDC reticle
- > Second focal plane
- > Aerospace-grade 1" maintube
- > Fully multi-coated lens for maximum clarity
- > Generous 4" eye relief
- > Spring-loaded zero-reset capped turrets
- > Waterproof, shockproof, and nitrogen purged
- > Lightweight aluminum construction, 16.2 oz.
- > CT Lifetime Warranty



CT CUSTOM BDC RETICLE



Get the precise bullet drops for your ammunition and atmospheric conditions using the FREE Crimson Trace Ballistic Calculator.

The Crimson Trace® Brushline™ dedicated hunting optics have been purposefully built from the ground up. The line features aerospace-grade 1" and 30mm maintubes that are lightweight, durable, and reliable. They are nitrogen-purged, waterproof, shockproof, and they are fully multi-coated in our MOC coatings. All Brushline™ scopes are covered by our Crimson Trace® LIFETIME WARRANTY and are backed by our award-winning customer service team.

3-9x50mm

01-01570 UPC - 810048570027 Case Pack 1
Box Dimensions: 13.5" l x 4" w x 3.5" h

- > Optimized hunting optic
- > Diamond-pattern BDC reticle
- > Second focal plane
- > Aerospace-grade 1" maintube
- > Fully multi-coated lens for maximum clarity
- > Generous 4" eye relief
- > Spring-loaded zero-reset capped turrets
- > Waterproof, shockproof, and nitrogen purged
- > Lightweight aluminum construction, 20.4 oz.
- > CT Lifetime Warranty

CT CUSTOM BDC RETICLE



Get the precise bullet drops for your ammunition and atmospheric conditions using the **FREE** Crimson Trace Ballistic Calculator.

The Crimson Trace® Brushline™ dedicated hunting optics have been purposefully built from the ground up. The line features aerospace-grade 1" and 30mm maintubes that are lightweight, durable, and reliable. They are nitrogen-purged, waterproof, shockproof, and they are fully multi-coated in our MOC coatings. All Brushline™ scopes are covered by our Crimson Trace® LIFETIME WARRANTY and are backed by our award-winning customer service team.



RIMFIRE 2-7x32mm

01-01290 UPC - 810048570195 Case Pack 1
 Box Dimensions: 13.5" l x 4" w x 3.5" h

- > Optimized hunting optic
- > Dedicated rimfire reticle
- > Second focal plane
- > Aerospace-grade 1" maintube
- > Fully multi-coated lens for maximum clarity
- > Generous 4" eye relief
- > Spring-loaded zero-reset exposed turrets
- > Waterproof, shockproof, and nitrogen purged
- > Lightweight aluminum construction, 13.6 oz.
- > CT Lifetime Warranty



CT CUSTOM BDC RIMFIRE RETICLE



Get the precise bullet drops for your ammunition and atmospheric conditions using the FREE Crimson Trace Ballistic Calculator.

The Crimson Trace® Brushline™ dedicated hunting optics have been purposefully built from the ground up. The line features aerospace-grade 1" and 30mm maintubes that are lightweight, durable, and reliable. They are nitrogen-purged, waterproof, shockproof, and they are fully multi-coated in our MOC coatings. All Brushline™ scopes are covered by our Crimson Trace® LIFETIME WARRANTY and are backed by our award-winning customer service team.

2-7x32mm

01-01440 UPC - 810048570126 Case Pack 1
 Box Dimensions: 13.5" l x 4" w x 3.5" h

- > Optimized hunting optic
- > Diamond-pattern BDC reticle
- > Second focal plane
- > Aerospace-grade 1" maintube
- > Fully multi-coated lens for maximum clarity
- > Generous 4" eye relief
- > Spring-loaded zero-reset capped turrets
- > Waterproof, shockproof, and nitrogen purged
- > Lightweight aluminum construction, 13.6 oz.
- > CT Lifetime Warranty



CT CUSTOM BDC RETICLE



Get the precise bullet drops for your ammunition and atmospheric conditions using the FREE Crimson Trace Ballistic Calculator.

The Crimson Trace® Brushline™ dedicated hunting optics have been purposefully built from the ground up. The line features aerospace-grade 1" and 30mm maintubes that are lightweight, durable, and reliable. They are nitrogen-purged, waterproof, shockproof, and they are fully multi-coated in our MOC coatings. All Brushline™ scopes are covered by our Crimson Trace® LIFETIME WARRANTY and are backed by our award-winning customer service team.

3-9x50mm

01-01480 UPC - 810048570140 Case Pack 1
Box Dimensions: 13.5" l x 4" w x 3.5" h

- > Optimized hunting optic
- > Diamond-pattern BDC Pro reticle
- > Second focal plane
- > Aerospace-grade 1" maintube
- > Fully multi-coated lens for maximum clarity
- > Generous 3.5" eye relief
- > Spring-loaded zero reset capped turrets
- > Waterproof, shockproof, and nitrogen purged
- > Lightweight aluminum construction, 17.6 oz.
- > CT Lifetime Warranty



CT CUSTOM BDC PRO RETICLE



Get the precise bullet drops for your ammunition and atmospheric conditions using the **FREE** Crimson Trace Ballistic Calculator.

The Crimson Trace® Brushline™ dedicated hunting optics have been purposefully built from the ground up. The line features aerospace-grade 1" and 30mm maintubes that are lightweight, durable, and reliable. They are nitrogen-purged, waterproof, shockproof, and they are fully multi-coated in our MOC coatings. All Brushline™ scopes are covered by our Crimson Trace® LIFETIME WARRANTY and are backed by our award-winning customer service team.

3-9x40mm

01-01450 UPC - 810048570232 Case Pack 1
Box Dimensions: 13.5" l x 4" w x 3.5" h

- > Optimized hunting optic
- > Purpose-built from the ground up
- > Second focal plane
- > Aerospace-grade 1" maintube
- > Fully multi-coated lens for maximum clarity
- > Generous 4" eye relief
- > Spring-loaded zero-reset capped turrets
- > Waterproof, shockproof, and nitrogen purged
- > Lightweight aluminum construction, 15 oz.
- > CT Lifetime Warranty



CT PLEX RETICLE



Get the precise bullet drops for your ammunition and atmospheric conditions using the **FREE** Crimson Trace Ballistic Calculator.

The Crimson Trace® Brushline™ dedicated hunting optics have been purposefully built from the ground up. The line features aerospace-grade 1" and 30mm maintubes that are lightweight, durable, and reliable. They are nitrogen-purged, waterproof, shockproof, and they are fully multi-coated in our MOC coatings. All Brushline™ scopes are covered by our Crimson Trace® LIFETIME WARRANTY and are backed by our award-winning customer service team.

3-9x40mm

01-01460 UPC - 810048570133 Case Pack 1
Box Dimensions: 13.5" l x 4" w x 3.5" h

- > Optimized hunting optic
- > Diamond-pattern BDC Pro reticle
- > Second focal plane
- > Aerospace-grade 1" maintube
- > Fully multi-coated lens for maximum clarity
- > Generous 4" eye relief
- > Spring-loaded zero-reset capped turrets
- > Waterproof, shockproof, and nitrogen purged
- > Lightweight aluminum construction, 15.2 oz.
- > CT Lifetime Warranty

CT CUSTOM BDC PRO RETICLE



TRACE
BALLISTIC CALCULATOR
WWW.CRIMSONTRACE.COM

Get the precise bullet drops for your ammunition and atmospheric conditions using the FREE Crimson Trace Ballistic Calculator.



The Crimson Trace® Brushline™ dedicated hunting optics have been purposefully built from the ground up. The line features aerospace-grade 1" and 30mm maintubes that are lightweight, durable, and reliable. They are nitrogen-purged, waterproof, shockproof, and they are fully multi-coated in our MOC coatings. All Brushline™ scopes are covered by our Crimson Trace® LIFETIME WARRANTY and are backed by our award-winning customer service team.

SHOTGUN 3-9x40mm

01-01680 UPC - 810048570256 Case Pack 1
Box Dimensions: 13.5" l x 4" w x 3.5" h

- > Optimized hunting optic
- > Dedicated shotgun BDC reticle
- > Second focal plane
- > Aerospace-grade 1" maintube
- > Fully multi-coated lens for maximum clarity
- > Generous 5" eye relief
- > Spring-loaded zero-reset capped turrets
- > Waterproof, shockproof, and nitrogen purged
- > Lightweight aluminum construction, 13.8 oz.
- > CT Lifetime Warranty

CT CUSTOM BDC SLUGGER RETICLE



TRACE
BALLISTIC CALCULATOR
WWW.CRIMSONTRACE.COM

Get the precise bullet drops for your ammunition and atmospheric conditions using the FREE Crimson Trace Ballistic Calculator.



The Crimson Trace® Brushline™ dedicated hunting optics have been purposefully built from the ground up. The line features aerospace-grade 1" and 30mm maintubes that are lightweight, durable, and reliable. They are nitrogen-purged, waterproof, shockproof, and they are fully multi-coated in our MOC coatings. All Brushline™ scopes are covered by our Crimson Trace® LIFETIME WARRANTY and are backed by our award-winning customer service team.

MUZZLELOADER 3-9x40mm

CT CUSTOM BDC MUZZLELOADER RETICLE

01-01540 UPC - 810048570201 Case Pack 1
Box Dimensions: 13.5" l x 4" w x 3.5" h

- > Optimized hunting optic
- > Dedicated muzzleloader BDC reticle
- > Second focal plane
- > Aerospace-grade 1" maintube
- > Fully multi-coated lens for maximum clarity
- > Generous 5" eye relief
- > Spring-loaded zero reset capped turrets
- > Waterproof, shockproof, and nitrogen purged
- > Lightweight aluminum construction, 13.8 oz.
- > CT Lifetime Warranty



Get the precise bullet drops for your ammunition and atmospheric conditions using the FREE Crimson Trace Ballistic Calculator.

The Crimson Trace[®] Brushline[™] dedicated hunting optics have been purposefully built from the ground up. The line features aerospace-grade 1" and 30mm maintubes that are lightweight, durable, and reliable. They are nitrogen-purged, waterproof, shockproof, and they are fully multi-coated in our MOC coatings. All Brushline[™] scopes are covered by our Crimson Trace[®] LIFETIME WARRANTY and are backed by our award-winning customer service team.

3-9x40mm

CT CUSTOM BDC PREDATOR RETICLE

01-01520 UPC - 810048570171 Case Pack 1
Box Dimensions: 13.5" l x 4" w x 3.5" h

- > Optimized hunting optic
- > Custom predator diamond-pattern BDC reticle
- > Second focal plane
- > Aerospace-grade 1" maintube
- > Fully multi-coated lens for maximum clarity
- > Generous 4" eye relief
- > Spring-loaded zero-reset capped turrets
- > Waterproof, shockproof, and nitrogen purged
- > Lightweight aluminum construction, 15 oz.
- > CT Lifetime Warranty



Get the precise bullet drops for your ammunition and atmospheric conditions using the FREE Crimson Trace Ballistic Calculator.

The Crimson Trace[®] Brushline[™] dedicated hunting optics have been purposefully built from the ground up. The line features aerospace-grade 1" and 30mm maintubes that are lightweight, durable, and reliable. They are nitrogen-purged, waterproof, shockproof, and they are fully multi-coated in our MOC coatings. All Brushline[™] scopes are covered by our Crimson Trace[®] LIFETIME WARRANTY and are backed by our award-winning customer service team.

350 LEGEND 3-9x40mm

CT CUSTOM BDC 350 LEGEND RETICLE

01-01220 UPC - 810048570270 Case Pack 1
 Box Dimensions: 13.5" l x 4" w x 3.5" h

- > Optimized hunting optic
- > Dedicated .350 Legend BDC reticle
- > Second focal plane
- > Aerospace-grade 1" maintube
- > Fully multi-coated lens for maximum clarity
- > Generous 4" eye relief
- > Spring-loaded zero-reset capped turrets
- > Waterproof, shockproof, and nitrogen purged
- > Lightweight aluminum construction, 15 oz.
- > CT Lifetime Warranty



Get the precise bullet drops for your ammunition and atmospheric conditions using the FREE Crimson Trace Ballistic Calculator.

The Crimson Trace® Brushline™ dedicated hunting optics have been purposefully built from the ground up. The line features aerospace-grade 1" and 30mm maintubes that are lightweight, durable, and reliable. They are nitrogen-purged, waterproof, shockproof, and they are fully multi-coated in our MOC coatings. All Brushline™ scopes are covered by our Crimson Trace® LIFETIME WARRANTY and are backed by our award-winning customer service team.

4-12x40mm

CT CUSTOM BDC PRO RETICLE

01-01500 UPC - 810048570157 Case Pack 1
 Box Dimensions: 17.5" l x 4.5" w x 4" h

- > Optimized hunting optic
- > Diamond-pattern BDC Pro reticle
- > Second focal plane
- > Aerospace-grade 1" maintube
- > Fully multi-coated lens for maximum clarity
- > Generous 4" eye relief
- > Spring-loaded zero-reset capped turrets
- > Waterproof, shockproof, and nitrogen purged
- > Lightweight aluminum construction, 15.5 oz.
- > CT Lifetime Warranty



Get the precise bullet drops for your ammunition and atmospheric conditions using the FREE Crimson Trace Ballistic Calculator.

The Crimson Trace® Brushline™ dedicated hunting optics have been purposefully built from the ground up. The line features aerospace-grade 1" and 30mm maintubes that are lightweight, durable, and reliable. They are nitrogen-purged, waterproof, shockproof, and they are fully multi-coated in our MOC coatings. All Brushline™ scopes are covered by our Crimson Trace® LIFETIME WARRANTY and are backed by our award-winning customer service team.

4-12x40mm

01-01490 UPC - 810048570249 Case Pack 1
 Box Dimensions: 17.5" l x 4.5" w x 4" h

- > Optimized hunting optic
- > Purpose-built from the ground up
- > Second focal plane
- > Aerospace-grade 1" maintube
- > Fully multi-coated lens for maximum clarity
- > Generous 4" eye relief
- > Spring-loaded zero-reset capped turrets
- > Waterproof, shockproof, and nitrogen purged
- > Lightweight aluminum construction, 15.5 oz.
- > CT Lifetime Warranty

CT PLEX RETICLE



TRACE
 BALLISTIC CALCULATOR
WWW.CRIMSONTRACE.COM

Get the precise bullet drops for your ammunition and atmospheric conditions using the FREE Crimson Trace Ballistic Calculator.



The Crimson Trace® Brushline™ dedicated hunting optics have been purposefully built from the ground up. The line features aerospace-grade 1" and 30mm maintubes that are lightweight, durable, and reliable. They are nitrogen-purged, waterproof, shockproof, and they are fully multi-coated in our MOC coatings. All Brushline™ scopes are covered by our Crimson Trace® LIFETIME WARRANTY and are backed by our award-winning customer service team.

4-12x40mm

01-01530 UPC - 810048570188 Case Pack 1
 Box Dimensions: 17.5" l x 4.5" w x 4" h

- > Optimized hunting optic
- > Custom predator diamond-pattern BDC reticle
- > Second focal plane
- > Aerospace-grade 1" maintube
- > Fully multi-coated lens for maximum clarity
- > Generous 4" eye relief
- > Spring-loaded zero-reset capped turrets
- > Waterproof, shockproof, and nitrogen purged
- > Lightweight aluminum construction, 15.5 oz.
- > CT Lifetime Warranty

CT CUSTOM BDC PREDATOR RETICLE



TRACE
 BALLISTIC CALCULATOR
WWW.CRIMSONTRACE.COM

Get the precise bullet drops for your ammunition and atmospheric conditions using the FREE Crimson Trace Ballistic Calculator.



The Crimson Trace® Brushline™ dedicated hunting optics have been purposefully built from the ground up. The line features aerospace-grade 1" and 30mm maintubes that are lightweight, durable, and reliable. They are nitrogen-purged, waterproof, shockproof, and they are fully multi-coated in our MOC coatings. All Brushline™ scopes are covered by our Crimson Trace® LIFETIME WARRANTY and are backed by our award-winning customer service team.

2.5-10x42mm

CT CUSTOM BDC PRO RETICLE

01-01370 UPC - 810048570072 Case Pack 1
 Box Dimensions: 13.5" l x 4" w x 3.5" h

- > Optimized hunting optic
- > Diamond-pattern BDC Pro reticle
- > Second focal plane
- > Aerospace-grade 1" maintube
- > Fully multi-coated lens for maximum clarity
- > Generous 4" eye relief
- > Spring-loaded zero-reset capped turrets
- > Waterproof, shockproof, and nitrogen purged
- > Lightweight aluminum construction, 16.6 oz.
- > CT Lifetime Warranty



Get the precise bullet drops for your ammunition and atmospheric conditions using the FREE Crimson Trace Ballistic Calculator.

The Crimson Trace® Brushline™ dedicated hunting optics have been purposefully built from the ground up. The line features aerospace-grade 1" and 30mm maintubes that are lightweight, durable, and reliable. They are nitrogen-purged, waterproof, shockproof, and they are fully multi-coated in our MOC coatings. All Brushline™ scopes are covered by our Crimson Trace® LIFETIME WARRANTY and are backed by our award-winning customer service team.

2.5-10x42mm

CT PLEX RETICLE

01-01380 UPC - 810048570225 Case Pack 1
 Box Dimensions: 13.5" l x 4" w x 3.5" h

- > Optimized hunting optic
- > Purpose built from the ground up
- > Second focal plane
- > Aerospace-grade 1" maintube
- > Fully multi-coated lens for maximum clarity
- > Generous 4" eye relief
- > Spring-loaded zero-reset capped turrets
- > Waterproof, shockproof, and nitrogen purged
- > Lightweight aluminum construction, 16.6 oz.
- > CT Lifetime Warranty



Get the precise bullet drops for your ammunition and atmospheric conditions using the FREE Crimson Trace Ballistic Calculator.

The Crimson Trace® Brushline™ dedicated hunting optics have been purposefully built from the ground up. The line features aerospace-grade 1" and 30mm maintubes that are lightweight, durable, and reliable. They are nitrogen-purged, waterproof, shockproof, and they are fully multi-coated in our MOC coatings. All Brushline™ scopes are covered by our Crimson Trace® LIFETIME WARRANTY and are backed by our award-winning customer service team.

3-12x42mm

01-01390 UPC - 810048570089 Case Pack 1
 Box Dimensions: 13.5" l x 4" w x 3.5" h

- > Optimized hunting optic
- > Diamond-pattern BDC Pro reticle
- > Second focal plane
- > Aerospace-grade 1" maintube
- > Parallax (side focus) adjustment
- > Fully multi-coated lens for maximum clarity
- > Generous 4" eye relief
- > Spring-loaded zero-reset capped turrets
- > Waterproof, shockproof, and nitrogen purged
- > Lightweight aluminum construction, 18.7 oz.
- > CT Lifetime Warranty



CT CUSTOM BDC PRO RETICLE



Get the precise bullet drops for your ammunition and atmospheric conditions using the FREE Crimson Trace Ballistic Calculator.

The Crimson Trace® Brushline™ dedicated hunting optics have been purposefully built from the ground up. The line features aerospace-grade 1" and 30mm maintubes that are lightweight, durable, and reliable. They are nitrogen-purged, waterproof, shockproof, and they are fully multi-coated in our MOC coatings. All Brushline™ scopes are covered by our Crimson Trace® LIFETIME WARRANTY and are backed by our award-winning customer service team.

PISTOL 2.5-8x28mm

01-01600 UPC - 810048570164 Case Pack 1
 Box Dimensions: 13.5" l x 4" w x 3.5" h

- > Optimized hunting optic
- > Dedicated hunting pistol BDC Pro reticle
- > Second focal plane
- > Aerospace-grade 1" maintube
- > Fully multi-coated lens for maximum clarity
- > Generous 9" eye relief
- > Zero-reset capped turrets
- > Waterproof, shockproof, and nitrogen purged
- > Lightweight aluminum construction, 11.6 oz.
- > CT Lifetime Warranty



CT CUSTOM BDC PRO RETICLE



Get the precise bullet drops for your ammunition and atmospheric conditions using the FREE Crimson Trace Ballistic Calculator.

The Crimson Trace® Brushline™ dedicated hunting optics have been purposefully built from the ground up. The line features aerospace-grade 1" and 30mm maintubes that are lightweight, durable, and reliable. They are nitrogen-purged, waterproof, shockproof, and they are fully multi-coated in our MOC coatings. All Brushline™ scopes are covered by our Crimson Trace® LIFETIME WARRANTY and are backed by our award-winning customer service team.

4-16x42mm

01-01400 UPC - 810048570096 Case Pack 1
 Box Dimensions: 13.5" l x 4" w x 3.5" h

- > Optimized hunting optic
- > Diamond-pattern BDC Pro reticle
- > Second focal plane
- > Aerospace-grade 1" maintube
- > Parallax (side focus) adjustment
- > Fully multi-coated lens for maximum clarity
- > Generous 4" eye relief
- > Spring-loaded zero reset capped turrets
- > Waterproof, shockproof, and nitrogen purged
- > Lightweight aluminum construction, 18.9 oz.
- > CT Lifetime Warranty



CT CUSTOM BDC PRO RETICLE



Get the precise bullet drops for your ammunition and atmospheric conditions using the FREE Crimson Trace Ballistic Calculator.

The Crimson Trace[®] Brushline[™] dedicated hunting optics have been purposefully built from the ground up. The line features aerospace-grade 1" and 30mm maintubes that are lightweight, durable, and reliable. They are nitrogen-purged, waterproof, shockproof, and they are fully multi-coated in our MOC coatings. All Brushline[™] scopes are covered by our Crimson Trace[®] LIFETIME WARRANTY and are backed by our award-winning customer service team.

4-16x50mm

01-01420 UPC - 810048570102 Case Pack 1
 Box Dimensions: 17.5" l x 4.5" w x 4" h

- > Optimized hunting optic
- > Diamond-pattern BDC Pro reticle
- > Second focal plane
- > Aerospace-grade 1" maintube
- > Parallax (side focus) adjustment
- > Fully multi-coated lens for maximum clarity
- > Generous 4" eye relief
- > Spring-loaded zero-reset capped turrets
- > Waterproof, shockproof, and nitrogen purged
- > Lightweight aluminum construction, 19.2 oz.
- > CT Lifetime Warranty



CT CUSTOM BDC PRO RETICLE



Get the precise bullet drops for your ammunition and atmospheric conditions using the FREE Crimson Trace Ballistic Calculator.

The Crimson Trace[®] Brushline[™] dedicated hunting optics have been purposefully built from the ground up. The line features aerospace-grade 1" and 30mm maintubes that are lightweight, durable, and reliable. They are nitrogen-purged, waterproof, shockproof, and they are fully multi-coated in our MOC coatings. All Brushline[™] scopes are covered by our Crimson Trace[®] LIFETIME WARRANTY and are backed by our award-winning customer service team.

6-24x50mm

01-01430 UPC - 810048570119 Case Pack 1
 Box Dimensions: 17.5" l x 4.5" w x 4" h

- > Optimized hunting optic
- > Diamond-pattern BDC Pro reticle
- > Second focal plane
- > Aerospace-grade 1" maintube
- > Parallax (side focus) adjustment
- > Fully multi-coated lens for maximum clarity
- > Generous 4" eye relief
- > Spring-loaded zero-reset capped turrets
- > Waterproof, shockproof, and nitrogen purged
- > Lightweight aluminum construction, 20.5 oz.
- > CT Lifetime Warranty



CT CUSTOM BDC PRO RETICLE



Get the precise bullet drops for your ammunition and atmospheric conditions using the FREE Crimson Trace Ballistic Calculator.

The Crimson Trace® Brushline™ dedicated hunting optics have been purposefully built from the ground up. The line features aerospace-grade 1" and 30mm maintubes that are lightweight, durable, and reliable. They are nitrogen-purged, waterproof, shockproof, and they are fully multi-coated in our MOC coatings. All Brushline™ scopes are covered by our Crimson Trace® LIFETIME WARRANTY and are backed by our award-winning customer service team.

30mm TUBE 3-12x42mm

01-01300 UPC - 810048570058 Case Pack 1
 Box Dimensions: 17.5" l x 4.5" w x 4" h

- > Optimized hunting optic
- > Diamond-pattern BDC Pro reticle
- > Second focal plane
- > Aerospace-grade 30mm maintube
- > Parallax (side focus) adjustment
- > Fully multi-coated lens for maximum clarity
- > Generous 4" eye relief
- > Spring-loaded zero-reset capped turrets
- > Waterproof, shockproof, and nitrogen purged
- > Lightweight aluminum construction, 19.4 oz.
- > CT Lifetime Warranty



CT CUSTOM BDC PRO RETICLE



Get the precise bullet drops for your ammunition and atmospheric conditions using the FREE Crimson Trace Ballistic Calculator.

The Crimson Trace® Brushline™ dedicated hunting optics have been purposefully built from the ground up. The line features aerospace-grade 1" and 30mm maintubes that are lightweight, durable, and reliable. They are nitrogen-purged, waterproof, shockproof, and they are fully multi-coated in our MOC coatings. All Brushline™ scopes are covered by our Crimson Trace® LIFETIME WARRANTY and are backed by our award-winning customer service team.

30mm TUBE 3-12x42mm

01-01310 UPC - 810048570218 Case Pack 1
 Box Dimensions: 17.5" l x 4.5" w x 4" h

- > Optimized hunting optic
- > Purpose built from the ground up
- > Second focal plane
- > Aerospace-grade 30mm maintube
- > Parallax (side focus) adjustment
- > Fully multi-coated lens for maximum clarity
- > Generous 4" eye relief
- > Spring-loaded zero-reset capped turrets
- > Waterproof, shockproof, and nitrogen purged
- > Lightweight aluminum construction, 19.4 oz.
- > CT Lifetime Warranty



CT PLEX RETICLE



Get the precise bullet drops for your ammunition and atmospheric conditions using the FREE Crimson Trace Ballistic Calculator.

The Crimson Trace® Brushline™ dedicated hunting optics have been purposefully built from the ground up. The line features aerospace-grade 1" and 30mm maintubes that are lightweight, durable, and reliable. They are nitrogen-purged, waterproof, shockproof, and they are fully multi-coated in our MOC coatings. All Brushline™ scopes are covered by our Crimson Trace® LIFETIME WARRANTY and are backed by our award-winning customer service team.

30mm TUBE 4-16x50mm

01-01340 UPC - 810048570065 Case Pack 1
 Box Dimensions: 17.5" l x 4.5" w x 4" h

- > Optimized hunting optic
- > Diamond-pattern BDC Pro reticle
- > Second focal plane
- > Aerospace-grade 30mm maintube
- > Parallax (side focus) adjustment
- > Fully multi-coated lens for maximum clarity
- > Generous 3.7" eye relief
- > Spring-loaded zero reset capped turrets
- > Waterproof, shockproof, and nitrogen purged
- > Lightweight aluminum construction, 23 oz.
- > CT Lifetime Warranty



CT CUSTOM BDC PRO RETICLE



Get the precise bullet drops for your ammunition and atmospheric conditions using the FREE Crimson Trace Ballistic Calculator.

The Crimson Trace® Brushline™ dedicated hunting optics have been purposefully built from the ground up. The line features aerospace-grade 1" and 30mm maintubes that are lightweight, durable, and reliable. They are nitrogen-purged, waterproof, shockproof, and they are fully multi-coated in our MOC coatings. All Brushline™ scopes are covered by our Crimson Trace® LIFETIME WARRANTY and are backed by our award-winning customer service team.

3-9x40mm

CT CUSTOM MR1-MOA RETICLE

01-01200 UPC - 810048570355 Case Pack 1
 Box Dimensions: 13.5" l x 4" w x 3.5" h

- > Optimized target-shooting optic
- > Purpose built from the ground up
- > Second focal plane
- > Aerospace-grade 1" maintube
- > Fully multi-coated lens for maximum clarity
- > Generous 4" eye relief
- > Spring-loaded zero-reset exposed turrets
- > Waterproof, shockproof, and nitrogen purged
- > Lightweight aluminum construction, 15.2 oz.
- > CT Lifetime Warranty

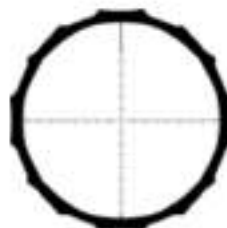

TRACE
 BALLISTIC CALCULATOR
www.CrimsonTrace.com

Get the precise bullet drops for your ammunition and atmospheric conditions using the FREE Crimson Trace Ballistic Calculator.



The Crimson Trace® Hardline™ optics are designed with the tactical, competition, and target shooter in mind. The line features aerospace-grade 1" and 30mm maintubes, illumination options, Mil and MOA reticle options, and first and second focal plane options. Hardline™ scopes boast generous eye relief for rapid target transitions, zero-rest turrets, and the quality and durability Crimson Trace® is known for. They are fully multi-coated, nitrogen purged, waterproof, and will stand up in the field to harsh environments. All Hardline™ scopes are covered by our Crimson Trace® LIFETIME WARRANTY and are backed by our award-winning customer service team.

3-9x40mm

CT CUSTOM BDC .223/5.56 RETICLE

01-01240 UPC - 810048570287 Case Pack 1
 Box Dimensions: 17.5" l x 4.5" w x 4" h

- > Optimized target-shooting optic
- > Dedicated .223/5.56 BDC reticle
- > Second focal plane
- > Aerospace grade 1" maintube
- > Fully multi-coated lens for maximum clarity
- > Generous 4" eye relief
- > Spring-loaded zero-reset exposed turrets
- > Waterproof, shockproof, and nitrogen purged
- > Lightweight aluminum construction, 15.2 oz.
- > CT Lifetime Warranty

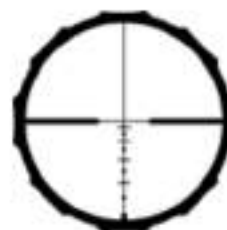

TRACE
 BALLISTIC CALCULATOR
www.CrimsonTrace.com

Get the precise bullet drops for your ammunition and atmospheric conditions using the FREE Crimson Trace Ballistic Calculator.



The Crimson Trace® Hardline™ optics are designed with the tactical, competition, and target shooter in mind. The line features aerospace-grade 1" and 30mm maintubes, illumination options, Mil and MOA reticle options, and first and second focal plane options. Hardline™ scopes boast generous eye relief for rapid target transitions, zero-rest turrets, and the quality and durability Crimson Trace® is known for. They are fully multi-coated, nitrogen purged, waterproof, and will stand up in the field to harsh environments. All Hardline™ scopes are covered by our Crimson Trace® LIFETIME WARRANTY and are backed by our award-winning customer service team.

2-7x32mm
CT CUSTOM BDC BLACKOUT RETICLE

01-01260 UPC - 810048570324 Case Pack 1
 Box Dimensions: 13.5" l x 4" w x 3.5" h

- > Optimized close-range tactical optic
- > Dedicated .300 AAC Blackout BDC reticle
- > Second focal plane
- > Aerospace-grade 1" maintube
- > Fully multi-coated lens for maximum clarity
- > Generous 4" eye relief
- > Spring-loaded zero-reset exposed turrets
- > Waterproof, shockproof, and nitrogen purged
- > Lightweight aluminum construction, 13.6 oz.
- > CT Lifetime Warranty



Get the precise bullet drops for your ammunition and atmospheric conditions using the FREE Crimson Trace Ballistic Calculator.

The Crimson Trace® Hardline™ optics are designed with the tactical, competition, and target shooter in mind. The line features aerospace-grade 1" and 30mm maintubes, illumination options, Mil and MOA reticle options, and first and second focal plane options. Hardline™ scopes boast generous eye relief for rapid target transitions, zero-rest turrets, and the quality and durability Crimson Trace® is known for. They are fully multi-coated, nitrogen purged, waterproof, and will stand up in the field to harsh environments. All Hardline™ scopes are covered by our Crimson Trace® LIFETIME WARRANTY and are backed by our award-winning customer service team.

4-12x40mm
CT MILDOT RETICLE

01-01510 UPC - 810048570331 Case Pack 1
 Box Dimensions: 17.5" l x 4.5" w x 4" h

- > Optimized mid-range target-shooting optic
- > MILDOT reticle
- > Second focal plane
- > Aerospace-grade 1" maintube
- > Fully multi-coated lens for maximum clarity
- > Generous 4" eye relief
- > Spring-loaded zero-reset capped turrets
- > Waterproof, shockproof, and nitrogen purged
- > Lightweight aluminum construction, 16.2 oz.
- > CT Lifetime Warranty

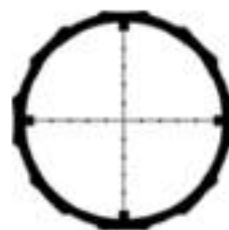

Get the precise bullet drops for your ammunition and atmospheric conditions using the FREE Crimson Trace Ballistic Calculator.

The Crimson Trace® Hardline™ optics are designed with the tactical, competition, and target shooter in mind. The line features aerospace-grade 1" and 30mm maintubes, illumination options, Mil and MOA reticle options, and first and second focal plane options. Hardline™ scopes boast generous eye relief for rapid target transitions, zero-rest turrets, and the quality and durability Crimson Trace® is known for. They are fully multi-coated, nitrogen purged, waterproof, and will stand up in the field to harsh environments. All Hardline™ scopes are covered by our Crimson Trace® LIFETIME WARRANTY and are backed by our award-winning customer service team.

4-12x40mm
CT CUSTOM BDC .223/5.56 RETICLE

01-01250 UPC - 810048570294 Case Pack 1
 Box Dimensions: 17.5" l x 4.5" w x 4" h

- > Optimized target-shooting optic
- > Dedicated .223/5.56 BDC reticle
- > Second focal plane
- > Aerospace-grade 1" maintube
- > Fully multi-coated lens for maximum clarity
- > Generous 4" eye relief
- > Spring-loaded zero-reset exposed turrets
- > Waterproof, shockproof, and nitrogen purged
- > Lightweight aluminum construction, 16.2 oz.
- > CT Lifetime Warranty

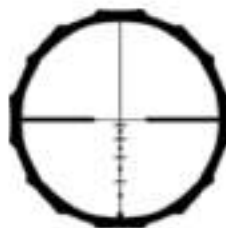

Get the precise bullet drops for your ammunition and atmospheric conditions using the FREE Crimson Trace Ballistic Calculator.

The Crimson Trace® Hardline™ optics are designed with the tactical, competition, and target shooter in mind. The line features aerospace-grade 1" and 30mm maintubes, illumination options, Mil and MOA reticle options, and first and second focal plane options. Hardline™ scopes boast generous eye relief for rapid target transitions, zero-rest turrets, and the quality and durability Crimson Trace® is known for. They are fully multi-coated, nitrogen purged, waterproof, and will stand up in the field to harsh environments. All Hardline™ scopes are covered by our Crimson Trace® LIFETIME WARRANTY and are backed by our award-winning customer service team.

4-12x40mm
CT CUSTOM BDC LONG RANGE RETICLE

01-01270 UPC - 810048570317 Case Pack 1
 Box Dimensions: 17.5" l x 4.5" w x 4" h

- > Optimized long-range optic
- > Long Range BDC reticle
- > Second focal plane
- > Aerospace-grade 1" maintube
- > Fully multi-coated lens for maximum clarity
- > Generous 4" eye relief
- > Spring-loaded zero-reset exposed turrets
- > Waterproof, shockproof, and nitrogen purged
- > Lightweight aluminum construction, 16.2 oz.
- > CT Lifetime Warranty



Get the precise bullet drops for your ammunition and atmospheric conditions using the FREE Crimson Trace Ballistic Calculator.

The Crimson Trace® Hardline™ optics are designed with the tactical, competition, and target shooter in mind. The line features aerospace-grade 1" and 30mm maintubes, illumination options, Mil and MOA reticle options, and first and second focal plane options. Hardline™ scopes boast generous eye relief for rapid target transitions, zero-rest turrets, and the quality and durability Crimson Trace® is known for. They are fully multi-coated, nitrogen purged, waterproof, and will stand up in the field to harsh environments. All Hardline™ scopes are covered by our Crimson Trace® LIFETIME WARRANTY and are backed by our award-winning customer service team.

4-16x42mm

CT CUSTOM MR1-MOA RETICLE

01-01410 UPC - 810048570362 Case Pack 1
 Box Dimensions: 13.5" l x 4" w x 3.5" h

- > Optimized long-range optic
- > Purpose built from the ground up
- > Second focal plane
- > Aerospace-grade 1" maintube
- > Parallax (side focus) adjustment
- > Fully multi-coated lens for maximum clarity
- > Generous 4" eye relief
- > Spring-loaded zero reset exposed turrets
- > Waterproof, shockproof, and nitrogen purged
- > Lightweight aluminum construction, 18.9 oz.
- > CT Lifetime Warranty

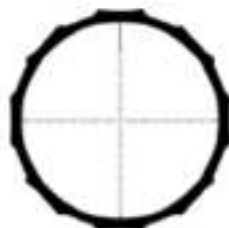

Get the precise bullet drops for your ammunition and atmospheric conditions using the FREE Crimson Trace Ballistic Calculator.

The Crimson Trace® Hardline™ optics are designed with the tactical, competition, and target shooter in mind. The line features aerospace-grade 1" and 30mm maintubes, illumination options, Mil and MOA reticle options, and first and second focal plane options. Hardline™ scopes boast generous eye relief for rapid target transitions, zero-rest turrets, and the quality and durability Crimson Trace® is known for. They are fully multi-coated, nitrogen purged, waterproof, and will stand up in the field to harsh environments. All Hardline™ scopes are covered by our Crimson Trace® LIFETIME WARRANTY and are backed by our award-winning customer service team.

30mm TUBE 3-12x42mm

CT CUSTOM MR1-MOA RETICLE

01-01160 UPC - 810048570348 Case Pack 1
 Box Dimensions: 13.5" l x 4" w x 3.5" h

- > Optimized mid-range optic
- > Purpose built from the ground up
- > Second focal plane
- > Aerospace-grade 30mm maintube
- > Parallax (side focus) adjustment
- > Fully multi-coated lens for maximum clarity
- > Generous 4" eye relief
- > Spring-loaded zero-reset exposed turrets
- > Waterproof, shockproof, and nitrogen purged
- > Lightweight aluminum construction, 20 oz.
- > CT Lifetime Warranty

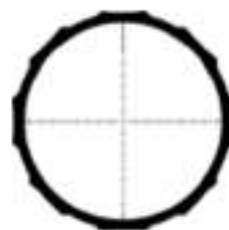

Get the precise bullet drops for your ammunition and atmospheric conditions using the FREE Crimson Trace Ballistic Calculator.

The Crimson Trace® Hardline™ optics are designed with the tactical, competition, and target shooter in mind. The line features aerospace-grade 1" and 30mm maintubes, illumination options, Mil and MOA reticle options, and first and second focal plane options. Hardline™ scopes boast generous eye relief for rapid target transitions, zero-rest turrets, and the quality and durability Crimson Trace® is known for. They are fully multi-coated, nitrogen purged, waterproof, and will stand up in the field to harsh environments. All Hardline™ scopes are covered by our Crimson Trace® LIFETIME WARRANTY and are backed by our award-winning customer service team.

30mm TUBE 3-12x42mm

01-01170 UPC - 810048570379 Case Pack 1
Box Dimensions: 13.5" l x 4" w x 3.5" h

- > Optimized mid-range optic
- > Purpose built from the ground up
- > Second focal plane
- > Aerospace-grade 30mm maintube
- > Parallax (side focus) adjustment
- > Fully multi-coated lens for maximum clarity
- > Generous 3.7" eye relief
- > Spring-loaded zero-reset exposed turrets
- > Waterproof, shockproof, and nitrogen purged
- > Lightweight aluminum construction, 20 oz.
- > CT Lifetime Warranty



CT CUSTOM MR1-MIL RETICLE

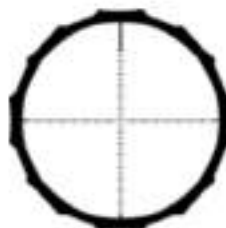

Get the precise bullet drops for your ammunition and atmospheric conditions using the FREE Crimson Trace Ballistic Calculator.

The Crimson Trace® Hardline™ optics are designed with the tactical, competition, and target shooter in mind. The line features aerospace-grade 1" and 30mm maintubes, illumination options, Mil and MOA reticle options, and first and second focal plane options. Hardline™ scopes boast generous eye relief for rapid target transitions, zero-rest turrets, and the quality and durability Crimson Trace® is known for. They are fully multi-coated, nitrogen purged, waterproof, and will stand up in the field to harsh environments. All Hardline™ scopes are covered by our Crimson Trace® LIFETIME WARRANTY and are backed by our award-winning customer service team.

30mm TUBE 4-16x42mm

01-01180 UPC - 810048570263 Case Pack 1
Box Dimensions: 13.5" l x 4" w x 3.5" h

- > Optimized long-range optic
- > Dedicated .223/5.56 BDC reticle
- > Second focal plane
- > Aerospace-grade 30mm maintube
- > Parallax (side focus) adjustment
- > Fully multi-coated lens for maximum clarity
- > Generous 3.7" eye relief
- > Spring-loaded zero-reset exposed turrets
- > Waterproof, shockproof, and nitrogen purged
- > Lightweight aluminum construction, 20 oz.
- > CT Lifetime Warranty



CT CUSTOM BDC .223/5.56 RETICLE



Get the precise bullet drops for your ammunition and atmospheric conditions using the FREE Crimson Trace Ballistic Calculator.

The Crimson Trace® Hardline™ optics are designed with the tactical, competition, and target shooter in mind. The line features aerospace-grade 1" and 30mm maintubes, illumination options, Mil and MOA reticle options, and first and second focal plane options. Hardline™ scopes boast generous eye relief for rapid target transitions, zero-rest turrets, and the quality and durability Crimson Trace® is known for. They are fully multi-coated, nitrogen purged, waterproof, and will stand up in the field to harsh environments. All Hardline™ scopes are covered by our Crimson Trace® LIFETIME WARRANTY and are backed by our award-winning customer service team.

30mm TUBE 4-16x42mm

CT CUSTOM BDC LONG RANGE RETICLE

01-0190 UPC - 810048570300 Case Pack 1
Box Dimensions: 13.5" l x 4" w x 3.5" h

- > Optimized long-range optic
- > Custom long-range BDC reticle
- > Second focal plane
- > Aerospace-grade 30mm maintube
- > Parallax (side focus) adjustment
- > Fully multi-coated lens for maximum clarity
- > Generous 3.7" eye relief
- > Spring-loaded zero-reset exposed turrets
- > Waterproof, shockproof, and nitrogen purged
- > Lightweight aluminum construction, 20 oz.
- > CT Lifetime Warranty



Get the precise bullet drops for your ammunition and atmospheric conditions using the FREE Crimson Trace Ballistic Calculator.

The Crimson Trace® Hardline™ optics are designed with the tactical, competition, and target shooter in mind. The line features aerospace-grade 1" and 30mm maintubes, illumination options, Mil and MOA reticle options, and first and second focal plane options. Hardline™ scopes boast generous eye relief for rapid target transitions, zero-rest turrets, and the quality and durability Crimson Trace® is known for. They are fully multi-coated, nitrogen purged, waterproof, and will stand up in the field to harsh environments. All Hardline™ scopes are covered by our Crimson Trace® LIFETIME WARRANTY and are backed by our award-winning customer service team.



COMPETITION 1-6x24mm

01-01100 UPC - 810048570478 Case Pack 1
 Box Dimensions: 13.5" l x 4" w x 3.5" h

- > Optimized close-quarters/competition optic
- > Custom segmented, illuminated competition reticle
- > Second focal plane
- > Aerospace-grade 30mm maintube
- > Fully multi-coated lens for maximum clarity
- > Generous 4" eye relief
- > Zero-reset capped turrets
- > Waterproof, shockproof, and nitrogen purged
- > Lightweight aluminum construction, 21.2 oz.
- > CT Lifetime Warranty

ILLUMINATED CT CUSTOM COMPETITION RETICLE



TRACE
 BALLISTIC CALCULATOR
WWW.CRIMSONTRACE.COM

Get the precise bullet drops for your ammunition and atmospheric conditions using the FREE Crimson Trace Ballistic Calculator.



The Crimson Trace® Hardline™ optics are designed with the tactical, competition, and target shooter in mind. The line features aerospace-grade 1" and 30mm maintubes, illumination options, Mil and MOA reticle options, and first and second focal plane options. Hardline™ scopes boast generous eye relief for rapid target transitions, zero-rest turrets, and the quality and durability Crimson Trace® is known for. They are fully multi-coated, nitrogen purged, waterproof, and will stand up in the field to harsh environments. All Hardline™ scopes are covered by our Crimson Trace® LIFETIME WARRANTY and are backed by our award-winning customer service team.

30mm TUBE 4-16x50mm

01-01070 UPC - 810048570485 Case Pack 1
 Box Dimensions: 17.5" l x 4.5" w x 4" h

- > Optimized long-range optic
- > Illuminated, glass-etched Mil reticle
- > Second focal plane
- > Aerospace-grade 30mm maintube
- > Parallax (side focus) adjustment
- > Fully multi-coated lens for maximum clarity
- > Generous 4" eye relief
- > Spring-loaded zero-reset exposed turrets
- > Waterproof, shockproof, and nitrogen purged
- > Lightweight aluminum construction, 25.4 oz.
- > CT Lifetime Warranty

ILLUMINATED CT CUSTOM MR1-MIL RETICLE



TRACE
 BALLISTIC CALCULATOR
WWW.CRIMSONTRACE.COM

Get the precise bullet drops for your ammunition and atmospheric conditions using the FREE Crimson Trace Ballistic Calculator.



The Crimson Trace® Hardline™ optics are designed with the tactical, competition, and target shooter in mind. The line features aerospace-grade 1" and 30mm maintubes, illumination options, Mil and MOA reticle options, and first and second focal plane options. Hardline™ scopes boast generous eye relief for rapid target transitions, zero-rest turrets, and the quality and durability Crimson Trace® is known for. They are fully multi-coated, nitrogen purged, waterproof, and will stand up in the field to harsh environments. All Hardline™ scopes are covered by our Crimson Trace® LIFETIME WARRANTY and are backed by our award-winning customer service team.

30mm TUBE 5-20x50mm

01-01360 UPC - 810048570447 Case Pack 1
 Box Dimensions: 17.5" l x 4.5" w x 4" h

- > Optimized long-range optic
- > Purpose built from the ground up
- > Second focal plane
- > Aerospace-grade 30mm maintube
- > Parallax (side focus) adjustment
- > Fully multi-coated lens for maximum clarity
- > Generous 4" eye relief
- > Spring-loaded zero-reset capped turrets
- > Waterproof, shockproof, and nitrogen purged
- > Lightweight aluminum construction, 23 oz.
- > CT Lifetime Warranty



CT CUSTOM MR1-MOA RETICLE

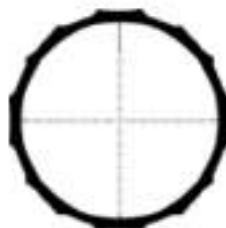

Get the precise bullet drops for your ammunition and atmospheric conditions using the FREE Crimson Trace Ballistic Calculator.

The Crimson Trace® Hardline™ optics are designed with the tactical, competition, and target shooter in mind. The line features aerospace-grade 1" and 30mm maintubes, illumination options, Mil and MOA reticle options, and first and second focal plane options. Hardline™ scopes boast generous eye relief for rapid target transitions, zero-rest turrets, and the quality and durability Crimson Trace® is known for. They are fully multi-coated, nitrogen purged, waterproof, and will stand up in the field to harsh environments. All Hardline™ scopes are covered by our Crimson Trace® LIFETIME WARRANTY and are backed by our award-winning customer service team.

30mm TUBE 4-16x50mm

01-01060 UPC - 810048570454 Case Pack 1
 Box Dimensions: 17.5" l x 4.5" w x 4" h

- > Optimized long-range tactical optic
- > Illuminated, glass-etched MOA reticle
- > First focal plane
- > Aerospace-grade 30mm maintube
- > Parallax (side focus) adjustment
- > Fully multi-coated lens for maximum clarity
- > Generous 4" eye relief
- > Spring-loaded zero-reset exposed turrets
- > Waterproof, shockproof, and nitrogen purged
- > Lightweight aluminum construction, 25.4 oz.
- > CT Lifetime Warranty



ILLUMINATED CT CUSTOM MR1-MOA RETICLE



Get the precise bullet drops for your ammunition and atmospheric conditions using the FREE Crimson Trace Ballistic Calculator.

The Crimson Trace® Hardline™ optics are designed with the tactical, competition, and target shooter in mind. The line features aerospace-grade 1" and 30mm maintubes, illumination options, Mil and MOA reticle options, and first and second focal plane options. Hardline™ scopes boast generous eye relief for rapid target transitions, zero-rest turrets, and the quality and durability Crimson Trace® is known for. They are fully multi-coated, nitrogen purged, waterproof, and will stand up in the field to harsh environments. All Hardline™ scopes are covered by our Crimson Trace® LIFETIME WARRANTY and are backed by our award-winning customer service team.

30mm TUBE 6-24x50mm

01-01090 UPC - 810048570461 Case Pack 1
Box Dimensions: 17.5" l x 4.5" w x 4" h

- > Optimized long-range optic
- > Illuminated, glass-etched MOA reticle
- > Second focal plane
- > Aerospace-grade 30mm maintube
- > Parallax (side focus) adjustment
- > Fully multi-coated lens for maximum clarity
- > Generous 4" eye relief
- > Spring-loaded zero-reset exposed turrets
- > Waterproof, shockproof, and nitrogen purged
- > Lightweight aluminum construction, 25.4 oz.
- > CT Lifetime Warranty

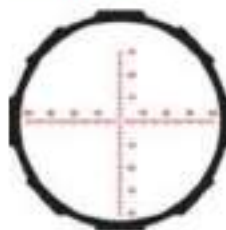

The Crimson Trace® Hardline™ optics are designed with the tactical, competition, and target shooter in mind. The line features aerospace-grade 1" and 30mm maintubes, illumination options, Mil and MOA reticle options, and first and second focal plane options. Hardline™ scopes boast generous eye relief for rapid target transitions, zero-rest turrets, and the quality and durability Crimson Trace® is known for. They are fully multi-coated, nitrogen purged, waterproof, and will stand up in the field to harsh environments. All Hardline™ scopes are covered by our Crimson Trace® LIFETIME WARRANTY and are backed by our award-winning customer service team.

ILLUMINATED CT CUSTOM MR1-MOA RETICLE**TRACE**
BALLISTIC CALCULATOR
WWW.CRIMSONTRACE.COM

Get the precise bullet drops for your ammunition and atmospheric conditions using the FREE Crimson Trace Ballistic Calculator.

30mm TUBE 6-24x50mm

01-01080 UPC - 810048570492 Case Pack 1
Box Dimensions: 17.5" l x 4.5" w x 4" h

- > Optimized long-range optic
- > Illuminated, glass-etched Mil reticle
- > Second focal plane
- > Aerospace-grade 30mm maintube
- > Parallax (side focus) adjustment
- > Fully multi-coated lens for maximum clarity
- > Generous 4" eye relief
- > Spring-loaded zero-reset exposed turrets
- > Waterproof, shockproof, and nitrogen purged
- > Lightweight aluminum construction, 25.4 oz.
- > CT Lifetime Warranty



The Crimson Trace® Hardline™ optics are designed with the tactical, competition, and target shooter in mind. The line features aerospace-grade 1" and 30mm maintubes, illumination options, Mil and MOA reticle options, and first and second focal plane options. Hardline™ scopes boast generous eye relief for rapid target transitions, zero-rest turrets, and the quality and durability Crimson Trace® is known for. They are fully multi-coated, nitrogen purged, waterproof, and will stand up in the field to harsh environments. All Hardline™ scopes are covered by our Crimson Trace® LIFETIME WARRANTY and are backed by our award-winning customer service team.

ILLUMINATED CT CUSTOM MR1-MIL RETICLE**TRACE**
BALLISTIC CALCULATOR
WWW.CRIMSONTRACE.COM

Get the precise bullet drops for your ammunition and atmospheric conditions using the FREE Crimson Trace Ballistic Calculator.

30mm TUBE 3-12x42mm

01-01320 UPC - 810048570423 Case Pack 1
 Box Dimensions: 13.5" l x 4" w x 3.5" h

- > Optimized mid-range tactical optic
- > Purpose built from the ground up
- > First focal plane
- > Aerospace-grade 30mm maintube
- > Parallax (side focus) adjustment
- > Fully multi-coated lens for maximum clarity
- > Generous 3.7" eye relief
- > Spring-loaded zero-reset capped turrets
- > Waterproof, shockproof, and nitrogen purged
- > Lightweight aluminum construction, 19.4 oz.
- > CT Lifetime Warranty



CT CUSTOM MR1-MOA RETICLE

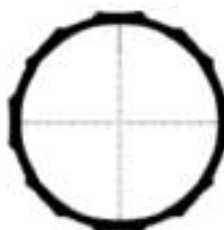

Get the precise bullet drops for your ammunition and atmospheric conditions using the FREE Crimson Trace Ballistic Calculator.

The Crimson Trace® Hardline™ optics are designed with the tactical, competition, and target shooter in mind. The line features aerospace-grade 1" and 30mm maintubes, illumination options, Mil and MOA reticle options, and first and second focal plane options. Hardline™ scopes boast generous eye relief for rapid target transitions, zero-rest turrets, and the quality and durability Crimson Trace® is known for. They are fully multi-coated, nitrogen purged, waterproof, and will stand up in the field to harsh environments. All Hardline™ scopes are covered by our Crimson Trace® LIFETIME WARRANTY and are backed by our award-winning customer service team.

30mm TUBE 4-16x50mm

01-01350 UPC - 810048570430 Case Pack 1
 Box Dimensions: 17.5" l x 4.5" w x 4" h

- > Optimized long-range tactical optic
- > Purpose built from the ground up
- > First focal plane
- > Aerospace-grade 30mm maintube
- > Parallax (side focus) adjustment
- > Fully multi-coated lens for maximum clarity
- > Generous 3.7" eye relief
- > Spring-loaded zero-reset capped turrets
- > Waterproof, shockproof, and nitrogen purged
- > Lightweight aluminum construction, 23 oz.
- > CT Lifetime Warranty



CT CUSTOM MR1-MOA RETICLE

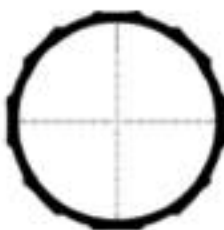

Get the precise bullet drops for your ammunition and atmospheric conditions using the FREE Crimson Trace Ballistic Calculator.

The Crimson Trace® Hardline™ optics are designed with the tactical, competition, and target shooter in mind. The line features aerospace-grade 1" and 30mm maintubes, illumination options, Mil and MOA reticle options, and first and second focal plane options. Hardline™ scopes boast generous eye relief for rapid target transitions, zero-rest turrets, and the quality and durability Crimson Trace® is known for. They are fully multi-coated, nitrogen purged, waterproof, and will stand up in the field to harsh environments. All Hardline™ scopes are covered by our Crimson Trace® LIFETIME WARRANTY and are backed by our award-winning customer service team.

30mm TUBE 6-24x50mm

01-01040 UPC - 810048570393 Case Pack 1
Box Dimensions: 17.5" l x 4.5" w x 4" h

- > Optimized long-range tactical optic
- > Illuminated, glass-etched MOA reticle
- > First focal plane
- > Aerospace-grade 30mm maintube
- > Parallax (side focus) adjustment
- > Zero stop with rev indicator
- > Fully multi-coated lens for maximum clarity
- > Generous 4" eye relief
- > Zero-reset exposed turrets
- > Waterproof, shockproof, and nitrogen purged
- > Lightweight aluminum construction, 25.4 oz.
- > CT Lifetime Warranty

ILLUMINATED CT CUSTOM MR1-MOA RETICLE

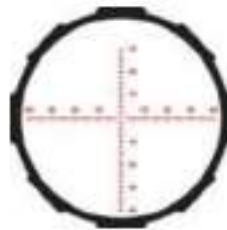

TRACE
BALLISTIC CALCULATOR
WWW.CRIMSONTRACE.COM

Get the precise bullet drops for your ammunition and atmospheric conditions using the FREE Crimson Trace Ballistic Calculator.



The Crimson Trace® Hardline™ optics are designed with the tactical, competition, and target shooter in mind. The line features aerospace-grade 1" and 30mm maintubes, illumination options, Mil and MOA reticle options, and first and second focal plane options. Hardline™ scopes boast generous eye relief for rapid target transitions, zero-rest turrets, and the quality and durability Crimson Trace® is know for. They are fully multi-coated, nitrogen purged, waterproof, and will stand up in the field to harsh environments. All Hardline™ scopes are covered by our Crimson Trace® LIFETIME WARRANTY and are backed by our award-winning customer service team.

30mm TUBE 6-24x50mm

01-01050 UPC - 810048570416 Case Pack 1
Box Dimensions: 17.5" l x 4.5" w x 4" h

- > Optimized long-range tactical optic
- > Illuminated, glass-etched Mil reticle
- > First focal plane
- > Aerospace-grade 30mm maintube
- > Parallax (side focus) adjustment
- > Zero stop with rev indicator
- > Fully multi-coated lens for maximum clarity
- > Generous 4" eye relief
- > Zero-reset exposed turrets
- > Waterproof, shockproof, and nitrogen purged
- > Lightweight aluminum construction, 25.4 oz.
- > CT Lifetime Warranty

ILLUMINATED CT CUSTOM MR1-MIL RETICLE

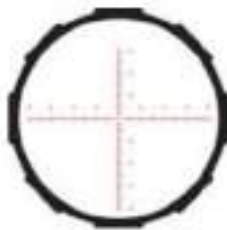

TRACE
BALLISTIC CALCULATOR
WWW.CRIMSONTRACE.COM

Get the precise bullet drops for your ammunition and atmospheric conditions using the FREE Crimson Trace Ballistic Calculator.



The Crimson Trace® Hardline™ optics are designed with the tactical, competition, and target shooter in mind. The line features aerospace-grade 1" and 30mm maintubes, illumination options, Mil and MOA reticle options, and first and second focal plane options. Hardline™ scopes boast generous eye relief for rapid target transitions, zero-rest turrets, and the quality and durability Crimson Trace® is know for. They are fully multi-coated, nitrogen purged, waterproof, and will stand up in the field to harsh environments. All Hardline™ scopes are covered by our Crimson Trace® LIFETIME WARRANTY and are backed by our award-winning customer service team.

30mm TUBE 4-16x50mm

01-01020 UPC - 810048570386 Case Pack 1
 Box Dimensions: 17.5" l x 4.5" w x 4" h

- > Optimized long-range tactical optic
- > Illuminated, glass-etched MOA reticle
- > First focal plane
- > Aerospace-grade 30mm maintube
- > Parallax (side focus) adjustment
- > Fully multi-coated lens for maximum clarity
- > Generous 4" eye relief
- > Zero-reset exposed turrets
- > Waterproof, shockproof, and nitrogen purged
- > Lightweight aluminum construction, 25.4 oz.
- > CT Lifetime Warranty

ILLUMINATED CT CUSTOM MR1-MOA RETICLE

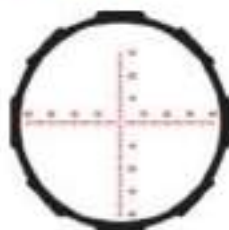

TRACE
 BALLISTIC CALCULATOR
www.CrimsonTrace.com

Get the precise bullet drops for your ammunition and atmospheric conditions using the FREE Crimson Trace Ballistic Calculator.



The Crimson Trace® Hardline™ optics are designed with the tactical, competition, and target shooter in mind. The line features aerospace-grade 1" and 30mm maintubes, illumination options, Mil and MOA reticle options, and first and second focal plane options. Hardline™ scopes boast generous eye relief for rapid target transitions, zero-rest turrets, and the quality and durability Crimson Trace® is know for. They are fully multi-coated, nitrogen purged, waterproof, and will stand up in the field to harsh environments. All Hardline™ scopes are covered by our Crimson Trace® LIFETIME WARRANTY and are backed by our award-winning customer service team.

30mm TUBE 4-16x50mm

01-01030 UPC - 810048570409 Case Pack 1
 Box Dimensions: 17.5" l x 4.5" w x 4" h

- > Optimized long-range tactical optic
- > Illuminated, glass-etched Mil reticle
- > First focal plane
- > Aerospace-grade 30mm maintube
- > Parallax (side focus) adjustment
- > Fully multi-coated lens for maximum clarity
- > Generous 4" eye relief
- > Zero-reset exposed turrets
- > Waterproof, shockproof, and nitrogen purged
- > Lightweight aluminum construction, 25.4 oz.
- > CT Lifetime Warranty

ILLUMINATED CT CUSTOM MR1-MIL RETICLE



TRACE
 BALLISTIC CALCULATOR
www.CrimsonTrace.com

Get the precise bullet drops for your ammunition and atmospheric conditions using the FREE Crimson Trace Ballistic Calculator.



The Crimson Trace® Hardline™ optics are designed with the tactical, competition, and target shooter in mind. The line features aerospace-grade 1" and 30mm maintubes, illumination options, Mil and MOA reticle options, and first and second focal plane options. Hardline™ scopes boast generous eye relief for rapid target transitions, zero-rest turrets, and the quality and durability Crimson Trace® is know for. They are fully multi-coated, nitrogen purged, waterproof, and will stand up in the field to harsh environments. All Hardline™ scopes are covered by our Crimson Trace® LIFETIME WARRANTY and are backed by our award-winning customer service team.

CTS-1550

01-01960 UPC - 850013143757 Case Pack 1
 Box Dimensions: 4.6" l x 3.5" w x 2.5" h

- > Micro red-dot sight
- > Battery life: 20,000 hours (2 years+)
- > Lightweight polymer construction
- > Notch cut for co-witness
- > CT Radiant™ Ambient light sensor
- > Bright red 3.0 MOA aiming dot

INTEGRATED CO-WITNESS SIGHT



The CTS-1550 Electronic Sight is an ultra compact open reflex sight for pistols. Featuring a 3.0 MOA round aiming dot, the CTS-1550 will elevate your pistol's performance instantly. It is easily user-installed by utilizing an industry standard mounting interface, and the CTS-1550 boasts a high efficiency LED for years of use.

CTS-1250

01-00560 UPC - 850013143405 Case Pack 1
 Box Dimensions: 4.6" l x 3.5" w x 2.5" h

- > Top accessible battery compartment
- > Battery life: 50,000 hours (6 years)
- > Industry standard mounting interface
- > Shock, impact, fog, and vibration resistant design
- > IPX7 Waterproof
- > Low-profile, snag-free design
- > High efficiency LED for years of maintenance-free use
- > Bright red 3.25 MOA aiming dot



The CTS-1250 Electronic Sight is a compact open reflex sight for full-size pistols. Featuring a 3.25 MOA round aiming dot, the CTS-1250 will elevate your pistol's performance instantly. It is easily user-installed by utilizing an industry standard mounting interface, and the CTS-1250 boasts a high efficiency LED for years of use.

CT RAD™ MICRO

01-01800 3 MOA RED UPC - 850013143825 Case Pack 1
Box Dimensions: TBD

01-3000018 5 MOA GREEN UPC - 850013143955 Case Pack 1
Box Dimensions: TBD

- > Designed for compact and sub compact firearms
- > Bottom accessible battery compartment
- > Battery life RED: 20,000 hours
- > Battery life GREEN: 7,000 hours
- > CT Radiant™ Ambient light sensor
- > CT micro™ footprint
- > Recessed optic lens
- > IPX4 Water resistant
- > Aerospace-grade aluminum construction

3 MOA RED DOT OR 5 MOA GREEN DOT



INTEGRATED CO-WITNESS SIGHT



The Rapid Aiming Dot (CT RAD) Micro and Micro Pro Electronic Sights are ultra compact open Reflex Sights for compact and sub compact pistols. Featuring a 3 MOA red and 5 MOA green round aiming dot, the CT RAD™ Micro will elevate your pistol's performance instantly. It is easily user-installed by utilizing an industry standard mounting interface, and they boast a high efficiency LED for years of use.

CT RAD™ MICRO PRO

01-01970 3 MOA RED UPC - 850013143665 Case Pack 1
Box Dimensions: TBD

01-3000038 5 MOA GREEN UPC - 850013143979 Case Pack 1
Box Dimensions: TBD

- > Designed for compact and sub compact firearms
- > Bottom accessible battery compartment
- > Battery life RED: 20,000 hours
- > Battery life GREEN: 7,000 hours
- > CT Radiant™ ambient light sensor
- > CT Motion™ shake-to-wake sensor
- > CT micro™ footprint
- > Recessed optic lens
- > IPX4 Water resistant
- > Aerospace-grade aluminum construction

3 MOA RED OR 5 MOA GREEN DOT



INTEGRATED CO-WITNESS SIGHT



The Rapid Aiming Dot (CT RAD) Micro and Micro Pro Electronic Sights are ultra compact open Reflex Sights for compact and sub compact pistols. Featuring a 3 MOA red or 5 MOA green round aiming dot, the CT RAD™ Micro will elevate your pistol's performance instantly. It is easily user-installed by utilizing an industry standard mounting interface, and they boast a high efficiency LED for years of use.

CT RAD™

01-01780 3 MOA RED DOT UPC - 850013143818
 Box Dimensions: TBD
 01-01890 5 MOA GREEN DOT UPC - 850013143856
 Box Dimensions: TBD

- > Designed for full size handguns
- > Top accessible battery compartment
- > Battery life Red: 20,000 hours
- > Battery life Green: 7,000 hours
- > CT RAD™ footprint
- > Auto Shutoff - automatic shut off after 8 hrs.
- > Manual ON/OFF
- > Easy-rack textured sides for enhanced grip
- > Recessed optic lens
- > IPX7 Waterproof
- > Large function buttons for brightness settings

3 MOA RED OR 5 MOA GREEN DOT

Case Pack 1

Case Pack 1

RENDER

The Rapid Aiming Dot (RAD) and RAD Pro electronic sights are compact open reflex sights for full-size pistols. Featuring a 3.0 MOA round aiming dot, the RAD will elevate your pistol's performance instantly. It is easily user-installed by utilizing an industry standard mounting interface, and they boast a high efficiency LED for years of use.

CT RAD™ PRO

01-01940 3 MOA RED DOT UPC - 850013143870
 Box Dimensions: TBD
 01-3000037 5 MOA GREEN DOT UPC - 850013143962
 Box Dimensions: TBD

- > Designed for full size handguns
- > Top accessible battery compartment
- > Battery life RED: 20,000 hours
- > Battery life GREEN: 7,000 hours
- > CT Radiant™ ambient light sensor
- > CT Motion™ shake-to-wake sensor
- > CT RAD™ footprint
- > Auto Shutoff - automatic shut off after 8 hrs.
- > Manual ON/OFF
- > Easy-rack textured sides for enhanced grip
- > Recessed optic lens
- > IPX7 Waterproof
- > Large function buttons for brightness settings

3 MOA RED OR 5 MOA GREEN DOT

Case Pack 1

Case Pack 1

RENDER

The Rapid Aiming Dot (CT RAD) and CT RAD™ Pro electronic sights are compact open reflex sights for full size pistols. Featuring a 3 MOA red or 5 MOA green round aiming dot, the CT RAD™ will elevate your pistol's performance instantly. It is easily user-installed by utilizing an industry standard mounting interface, and they boast a high efficiency LED for years of use.

CT RAD™ MAX

01-01980 UPC - 850013143672 Case Pack 1
Box Dimensions: TBD

- > Designed for rifles and shotguns
- > Top accessible battery compartment
- > Battery life: 50,000 hours
- > Auto Shutoff - automatic shut off after 8 hrs.
- > IPX7 Waterproof
- > Recessed optic lens
- > Easy-rack textured sides for enhanced grip
- > Large function buttons for brightness settings
- > Included low M1913 Picatinny mount



3 MOA RED DOT



INCLUDED PIC MOUNT



RENDER



The Rapid Aiming Dot (CT RAD) MAX and CT RAD™ MAX Pro red-dot sights are compact open reflex sights for rifles and shotguns. Featuring a 3 MOA round aiming dot and a wide field of view (FOV), the CT RAD™ MAX will elevate your long gun's performance instantly. It is easily user-installed, and they include a low-profile, snag-free M1913 Picatinny mount.

CT RAD™ MAX PRO

01-01990 UPC - 850013143689 Case Pack 1
Box Dimensions: TBD

- > Designed for rifles and shotguns
- > Top accessible battery compartment
- > Battery life: 50,000 hours
- > CT Radiant™ ambient light sensor
- > CT Motion™ shake-to-wake sensor
- > Auto Shutoff - automatic shut off after 8 hrs.
- > IPX7 Waterproof
- > Recessed optic lens
- > Easy-rack textured sides for enhanced grip
- > Large function buttons for brightness settings
- > Included low and high M1913 Picatinny mounts



3 MOA RED DOT



INCLUDED LOW AND HIGH PIC MOUNTS



RENDER



The Rapid Aiming Dot (CT RAD) MAX and CT RAD™ MAX Pro red-dot sights are compact open reflex sights for rifles and shotguns. Featuring a 3 MOA round aiming dot and a wide field of view (FOV), the CT RAD™ MAX will elevate your long gun's performance instantly. It is easily user-installed, and they include a low-profile, snag-free M1913 Picatinny mount.

CTS-25

01-02030 UPC - 850013143740 Case Pack 1
Box Dimensions: TBD

- > Side-accessible battery compartment
- > Removable riser (included)
- > Battery life: 8,000 hours (approx. 1 year)
- > Shock, impact, fog, water, and vibration resistant design
- > Large function buttons for brightness settings
- > 4 MOA dot
- > Included M1913 Picatinny riser mount
- > Crimson Protect Lifetime Warranty



1x MAGNIFICATION 4.0 MOA RED DOT



The CTS-25 electronic sight is a compact red-dot sight for rifles and carbines. Featuring a 4-MOA aiming dot, the CTS-25 will elevate your long gun's performance instantly. Installed in seconds by utilizing an included riser for rail mounting, the red dot attaches effortlessly to M1913 Picatinny rail sections.



LASERGUARD® HELLCAT

01-01830	RED LASER	UPC - 850013143788	Case Pack 1
Box Dimensions: TBD			
01-01820	GREEN LASER	UPC - 850013143771	Case Pack 1
Box Dimensions: TBD			

- > Red or green laser options
- > Instinctive Activation™
- > Windage and Elevation adjustment
- > Master ON/OFF switch
- > Batteries included
- > Crimson Protect Lifetime Warranty



FITS SPRINGFIELD ARMORY HELLCAT



The Crimson Trace® LaserGuard® is a powerful laser sight for the Springfield Armory Hellcat series of pistols. The unit is quickly and easily user-installed in moments and offers a front activation button powered by Crimson Trace's Instinctive Activation™ technology. The laser sight will provide 2 hours of battery life with a single 1/3N lithium battery (included). As with all Crimson Trace laser sights, it is completely user-adjustable for windage and elevation. This model features a master ON/OFF switch for completely powering down the unit to train without the laser sight.

RAIL MASTER® PRO CMR-301

01-00020	BLACK	UPC - 610242010110	Case Pack 1
Box Dimensions: 6" w x 4" d x 9.5" h			
01-00410	FDE	UPC - 850013143085	Case Pack 1
Box Dimensions: 6" w x 4" d x 9.5" h			

- > Black or FDE color options
- > Instant Activation™ - laser, light, laser and light
- > M1913 Picatinny rail and M-LOK® mounts
- > 1,000 (peak) lumen LED light
- > User selectable 1,000, 500 or 150 lumen output
- > Green laser
- > Push button and remote switch activation
- > Included rechargeable battery
- > Crimson Protect Lifetime Warranty



GREEN LASER WITH WHITE LED LIGHT



The Rail Master® Pro CMR-301 offers robust power and versatility for rail-equipped rifles and carbines. The laser sight + tactical light system provides 1,000 lumens (peak) for illumination and a powerful green laser for precision targeting in variable lighting conditions. The CMR-301 Pro is user-programmable and may be operated with pressure pad or tail-cap. It fits standard AR-type modern sporting rifles with M1913 Picatinny or M-LOK® similar accessory rails measuring at least 2¾ inches in length.

Rapid Illumination Grip (RIG)

01-01720 UPC - 850013143894 Case Pack 1
Box Dimensions: TBD

- > M-LOK®, Keymod & Picatinny adapters
- > USB rechargeable battery
- > 400 lumen LED light
- > Multi-hand position light activation
- > Heavy-duty polymer and aluminum construction
- > Picatinny rail adapter included
- > Included rechargeable battery
- > Crimson Protect Lifetime Warranty



M-LOK®, KEYMOD & PICATINNY ANGLED FORE GRIP WITH LIGHT



The Rapid Illumination Grip (RIG) offers robust power and versatility for rifles and carbines. The tactical light system provides 400 lumens (peak) and variable lighting controls to adjust brightness. The RIG also provides an integrated angled fore grip for proper grip and hand placement on the firearm. The rechargeable battery has a USB port for quick charging and reuse.





RETURNING PRODUCTS



ELECTRONIC SIGHTS



SIGHT MOUNTING CONFIGURATIONS:



CTS-1000

Includes a removable quick disconnect M1913 Picatinny compatible mount.



CTS-1100

Includes a repeatable integrated M1913 Picatinny compatible mount.



CTS-1300

Includes a removable low profile M1913 Picatinny compatible mount.



CTS-1400

Includes a removable low profile M1913 Picatinny compatible mount.

ELECTRONIC SIGHTS

BATTERY LIFE

Battery life varies depending on use but having years of experience dealing with battery powered accessories, we have developed the means to maximize potential battery life. For example, the CTS-1000 has a calculated run time close to a decade at medium brightness & the CTS-1400 utilizes innovations in intelligent battery management systems that senses motion and shuts off when not in use. As with the vast majority of our current products, all of our electronic sights and Riflescopes are included in the Free Batteries for Life program.

CTS - 1000

More than 81,000 hours*



CTS - 1100

More than 3,400 hours under standard use condition*



CTS - 1300

More than 15,000 hours under standard use condition*



CTS - 1400

More than 8,100 hours under standard use condition*



*Standard use condition: (Battery runtime based on the following) One three hour continuous use per week at level five intensity. Product is active during and after this use. Following the three hour period, products with power saving features will enter these modes.

CTS-1100 FEATURES + SPECIFICATIONS



PRODUCT

CTS-1100 / 3.5X BATTLESIGHT W/ BDC RETICLE



HYBRID BDC RETICLE

CTS-1000 FEATURES + SPECIFICATIONS

SIGHTS



PRODUCT

CTS-1000 / 2.0 MOA COMPACT RED DOT SIGHT



CTS-1300 FEATURES + SPECIFICATIONS



PRODUCT

CTS-1300 / 3.5 MOA COMPACT OPEN REFLEX SIGHT



CTS-1400 FEATURES + SPECIFICATIONS

SIGHTS



PRODUCT

CTS-1400 / 3.25 MOA OPEN REFLEX SIGHT





SIGHT RISERS FEATURES + SPECIFICATIONS

RISERS



PRODUCT



SIGHT RISERS		
Fits standard Picatinny rails.	CTS-1000	LOW MOUNT
	CTS-1200/1300	FULL CO-WITNESS
	CTS-1400	FULL CO-WITNESS
	CTS-1400	LOWER 1/3 CO-WITNESS



LASERSADDLE® FEATURES + SPECIFICATIONS

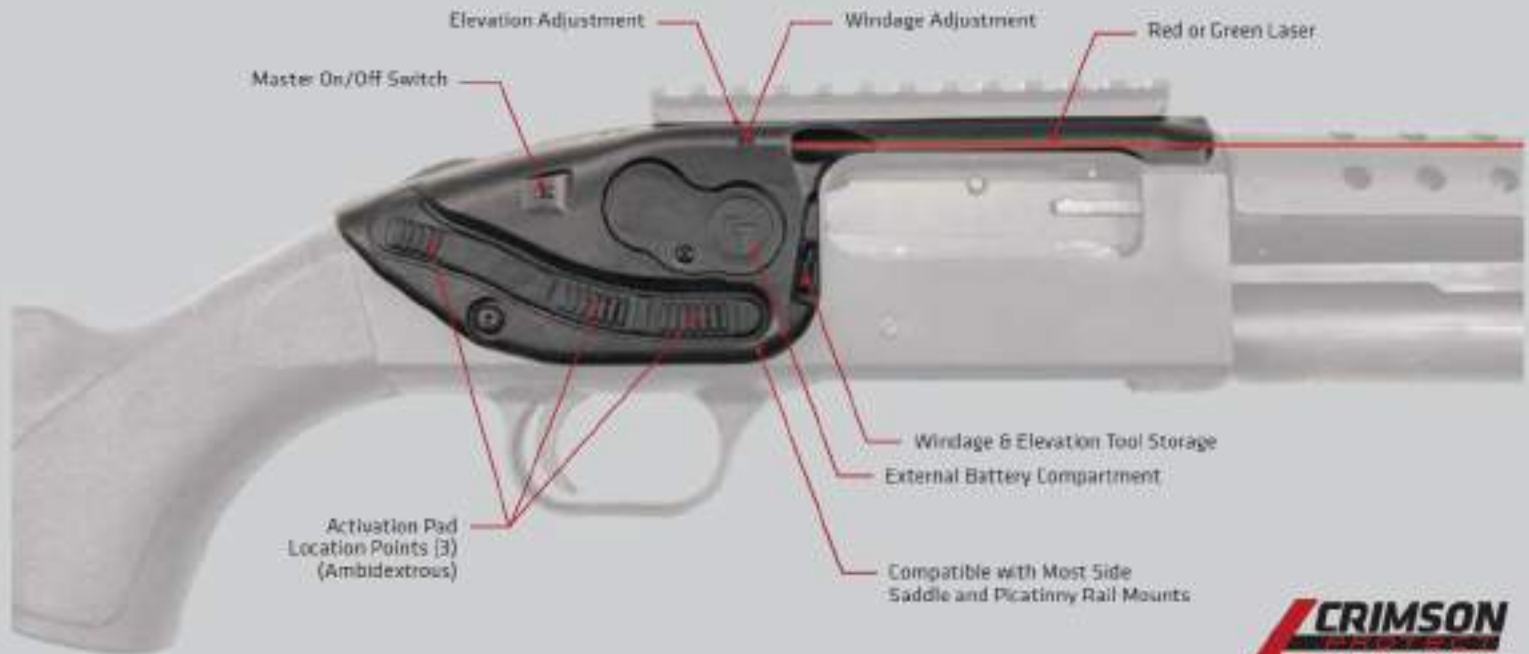

Lasersaddle® is a reimagining of shotgun targeting systems. Unrivalled performance allows for confidence when time is critical and quick targeting is necessary. Find the dot and take the thinking out of aiming. Lasersaddle® models fit most Mossberg 500, 590, 590A1 and Shockwave 12-gauge/20-gauge shotguns.

PRODUCT



• LS-250 FOR MOSSBERG 500 SERIES SHOTGUNS & SHOCKWAVE

LASERSADDLE®		
Compatible with most Mossberg 12-gauge 500 series, 590, 590A1 & Shockwave. Models must have a receiver that is drilled and tapped. *Includes shim for 20-gauge.	LS-250	•
	LS-250G	•

•/• NOW FITS THE 20-GAUGE



• LS-250G FOR MOSSBERG 500 SERIES SHOTGUNS & SHOCKWAVE

LASERSADDLE® FEATURES + SPECIFICATIONS

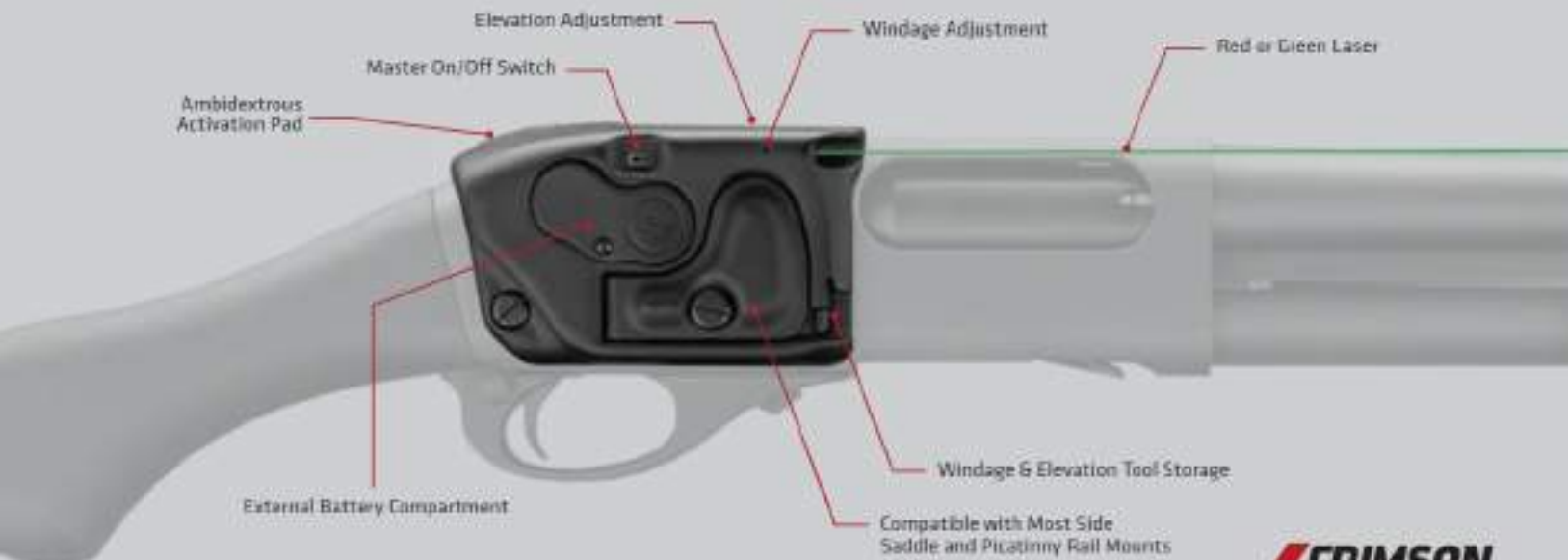

Lasersaddle® is a reimagining of shotgun targeting systems. Unrivalled performance allows for confidence when time is critical and quick targeting is necessary. Find the dot and take the thinking out of aiming. Lasersaddle® models fits the Remington model 870 and TAC-14 12-gauge shotguns.

PRODUCT



• LS-870G
FOR REMINGTON 870 SERIES
SHOTGUNS & TAC-14

LASERSADDLE®		
Fits the Remington model 870 and TAC-14 12-gauge shotgun.	LS-870	•
	LS-870G	•



• LS-870
FOR REMINGTON 870 SERIES
SHOTGUNS & TAC-14

RAIL MASTER® PRO FEATURES + SPECIFICATIONS



The Rail Master® Pro line combines Crimson Trace®'s laser sighting prowess with the versatility of a 400 Lumens LED white light. With four modes of operation and a durable aluminum housing, Rail Master Pro offers ambidextrous controls for exceptional usability. Models are designed to fit pistols, rifles or shotguns with accessory rails.

PRODUCT

RAIL EQUIPPED FIREARMS		
Pistols, rifles and shotguns with compatible M1913 Picatinny or Weaver accessory rails	CMR-207	●/☒
	CMR-207G	●/☒



●/☒ CMR-207 FOR RAIL EQUIPPED FIREARMS

RAIL MASTER® PRO FEATURES + SPECIFICATIONS

LASERS

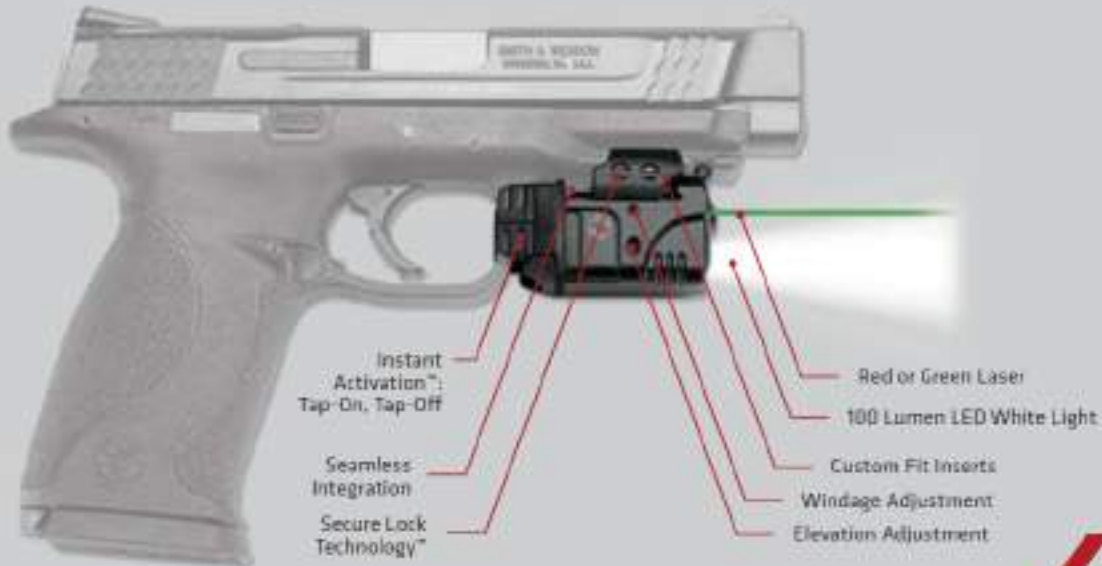

The Rail Master® Pro line combines Crimson Trace®'s laser sighting prowess with the versatility of a 100 Lumen LED white light. With four modes of operation and a durable aluminum housing, Rail Master Pro offers ambidextrous controls for exceptional usability. Models are designed to fit pistols, rifles or shotguns with accessory rails.

PRODUCT



•/• CMR-205 FOR RAIL EQUIPPED FIREARMS

RAIL EQUIPPED FIREARMS		
Pistols, rifles, and shotguns with compatible M1913 Picatinny or Weaver accessory rails	CMR-204	•/•
	CMR-205	•/•



•/• CMR-204 FOR RAIL EQUIPPED FIREARMS

RAIL MASTER® FEATURES + SPECIFICATIONS



The Rail Master® line offers universal fit, unmatched versatility and exceptional value. Among our most popular products, the Rail Master line offers your choice of visible red or green laser sighting options or powerful LED tactical lights. Rail Master models are designed to fit pistols, rifles or shotguns with modern accessory rails.

PRODUCT



• **CMR-201 CTAN**
FOR RAIL EQUIPPED FIREARMS

RAIL EQUIPPED FIREARMS		
Pistols, rifles and shotguns with compatible M1913 Picatinny or Weaver accessory rails.	CMR-201	•
	CMR-201 CTAN	•
	CMR-206	•



• **CMR-206**
FOR RAIL EQUIPPED FIREARMS

LASERGUARD® PRO FEATURES + SPECIFICATIONS

LASERS



The Laserguard® Pro line combines our unmatched laser sighting technology with the added benefit of 150 Lumens of white light. Utilizing Instinctive Activation™ technology for immediate deployment, Laserguard Pro features four user-programmable modes of operation. Fits many popular concealed carry and personal defense pistols.

PRODUCT



GLOCK		
Glock 42, 43	LL-803	• / -
	LL-803G	• / -
Third Generation 17, 17L, 19, 22, 23, 24, 25, 31, 32, 34, 35, 37, 38 Gen4 17, 19, 22, 23, 31, 32, 34, 35, 37 Gen5 17, 19, 19x, 45	LL-807	• / -
	LL-807G	• / -
Third Generation 26, 27, 33, 36 Gen4 26, 27, 33	LL-810	• / -
	LL-810G	• / -
SMITH & WESSON		
M&P 9 Shield, M&P 40 Shield M2.0	LL-801	• / -
	LL-801G	• / -
M&P 45 Shield	LL-808	• / -
	LL-808G	• / -
SPRINGFIELD ARMORY		
XD-S	LL-802	• / -
	LL-802G	• / -

LASERGUARD® FEATURES + SPECIFICATIONS



The Laserguard® line is the best-in-class sighting system for most popular compact and subcompact pistols. Featuring Crimson Trace®'s unmatched Instinctive Activation™ technology, Laserguard models mount quickly and securely around the pistol's trigger guard, enhancing your ability to engage threats quickly and accurately.

PRODUCT



• LG-422
FOR SIG SAUER P365



• LG-459G
FOR SIG SAUER M&P 380 SHIELD EZ
& 9MM SHIELD



• LG-422G
FOR SIG SAUER P365



• LG-459
FOR SIG SAUER M&P 380 SHIELD EZ
& 9MM SHIELD

BERETTA		
Nano 9mm	LG-483	●
GLOCK		
Glock 42, 43	LG-443	●
	LG-443G	●
Third Generation 19, 23, 25, 26, 27, 28, 32, 36, 38, 39; Gen4 19, 23, 26, 27, 32, 33; Gen5 19. Does NOT fit Glock 16 FCR	LG-436	●
HECKLER & KOCH		
VP9/40 and VP9SK	LG-499	●
	LG-499G	●
HONOR DEFENSE		
Honor Guard 9mm	LG-498	●
KAHR		
P380, CW380	LG-433	●
CW9, CW40, P9, P40, PM9, PM40, TP9, TP40, CT9, CT40, CT45	LG-437	●
KEL-TEC		
P3AT, P32 Generations I & II	LG-430	●
PF9	LG-435	●
REMINGTON		
RM380	LG-479	●
RUGER		
LCP	LG-431	●
LCP II	LG-497	●
	LG-497G	●
LC9, LC9s, LC380, Ec9s	LG-416	●
	LG-416G	●
SR9C, SR40C Compact	LG-449	●
SIG SAUER		
P238 and P938	LG-492	●
	LG-492G	●
P320	LG-420	●
	LG-420G	●
P365	LG-422	●
	LG-422G	●

SMITH & WESSON		
M&P M2.0 Full-Size & Compact	LG-362	●
	LG-362G	●
M&P Full-Size & Compact	LG-360G	●
M&P Bodyguard 380	LG-454	●
	LG-454G	●
M&P 45 Shield	LG-485	●
	LG-485G	●
M&P9 Shield & M&P Shield M2.0 9mm and .40 S&W	LG-489	●
	LG-489G	●
M&P 380 Shield EZ & 9mm Shield	LG-459	●
	LG-459G	●
SPRINGFIELD ARMORY		
XD MOD.2	LG-496	●
	LG-496G	●
XD, XD(M)	LG-448	●
XDs	LG-469	●
	LG-469G	●
TAURUS		
Slim 709 and 740	LG-447	●
TCP 738, 380	LG-407	●
Millennium Pro	LG-493	●
WALTHER		
PPS M2	LG-482	●
	LG-482G	●

MASTER SERIES™ FEATURES + SPECIFICATIONS



The Master Series™ line is the finest Lasergrips® available for your beloved 1911 pistol. Utilizing natural wood and G10 materials, Master Series models blend rugged artistry with advanced technology. All models feature our famed Instinctive Activation™ technology and ambi-safety compatibility. Also available for Kimber K6s revolvers.

PRODUCT





1911		
Full-Size: 1911 & 1991A1 single stack full-size frames with grip screws measuring 3 1/8" apart	LG-901 ROSEWOOD	●
	LG-901G ROSEWOOD	●
	LG-904 G10 GRAY	●
	LG-904G G10 GRAY	●
	LG-908 WALNUT	●
	LG-908G WALNUT	●
	LG-910 G10 GREEN/BLACK	●
	LG-910G G10 GREEN/BLACK	●
	LG-919 G10 BLACK	●
	LG-919G G10 BLACK	●
Compact: 1911 single stack compact frames with grip screws measuring 2 1/8" apart	LG-902 ROSEWOOD	●
	LG-902G ROSEWOOD	●
	LG-905 G10 GRAY	●
	LG-905G G10 GRAY	●
	LG-909 WALNUT	●
	LG-909G WALNUT	●
	LG-911 G10 GREEN/BLACK	●
	LG-911G G10 GREEN/BLACK	●
	LG-921 COCOBOLO DIAMOND	●
	LG-921G COCOBOLO DIAMOND	●

1911		
1911 Bobtail®-style single-stack frames with grip screws measuring 3 1/8" apart <small>*Ed Brown Bobtail is a registered trademark of Ed Brown Products, Inc. www.edbrown.com</small>	LG-903 ROSEWOOD	●
	LG-903G ROSEWOOD	●
	LG-906 G10 GRAY	●
	LG-906G G10 GRAY	●
1911 Round Heel-style single-stack frames with grip screws measuring 3 1/8" apart	LG-907 ROSEWOOD	●
	LG-907G ROSEWOOD	●
KIMBER		
K6s	LG-950 SLATEWOOD	●
	LG-951 G10 BLACK/GRAY	●
	LG-952 ROSEWOOD	●
SPRINGFIELD ARMORY		
EMP 3" model only	LG-912 G10 BLACK	●
	LG-912G G10 BLACK	●

LASERGRIPS® FEATURES + SPECIFICATIONS



The Lasergrips® line offers the history and technology that is the hallmark of the Crimson Trace® brand. Featuring Instinctive Activation™ for immediate target engagement, Lasergrips are the product line that put Crimson Trace® on the map and have changed the way shooters approach personal protection.

PRODUCT



• LG-410
FOR KIMBER EVO SP



• LG-409G
FOR KIMBER MICRO 9mm



• LG-410G
FOR KIMBER EVO SP



• LG-637G
FOR GLOCK FULL-SIZE

1911		
Full-Size: 1911 & 1991A1 single stack full-size frames with grip screws measuring 3 ¹ / ₁₆ " apart	LG-401	●
	LG-401G	●
Compact: 1911 single stack compact frames with grip screws measuring 2 ⁷ / ₁₆ " apart	LG-404	●
	LG-404G	●
BERETTA		
92 / 95 / M9	LG-402M	●
BERSA		
Thunder .380 / Firestorm .380	LG-442	●
Thunder 380CC	LG-646	●
BROWNING		
Hi-Power	LG-309	●
CHARTER ARMS		
Revolvers except Dixie Derringer & South Paw	LG-325	●
GLOCK		
Third Generation 17, 22, 31, 34, 35, 37, Gen4 17, 22, 31, 34, 35, 37, Gen5 17	LG-637	●
	LG-637G	●
Third Generation 19, 23, 25, 32, 38 Gen4 19, 23, 32 Gen5 19	LG-639	●
	LG-639G	●
Third Generation 17, 19, 22, 23, 31, 32, 34, 35, 37, 38	LG-417	●
Third Generation 26, 27, 28, 33, 39	LG-626	●
Third Generation 29, 30	LG-629	●
Gen4 26, 27, 33	LG-852	●
KIMBER		
Kimber EVO SP	LG-410	●
	LG-410G	●
Micro .380	LG-478	●
Micro 9mm	LG-409	●
	LG-409G	●
RUGER		
GP100, Super Redhawk, Alaskan	LG-344	●
LCR & LCRx	LG-415	●
	LG-415G	●
MK II and III	LG-403	●
P Series 85, 89, 90, 91, 93, 94 & 944	LG-389	●
SP101	LG-111	●
	LG-303	●

SIG SAUER		
P220	LG-320	●
P226	LG-426	●
	LG-426M	●
P228 / P229	LG-429	●
	LG-429M	●
P239	LG-439	●
SMITH & WESSON		
J Frame Round Butt	LG-105	●
	LG-305	●
	LG-350	●
	LG-350G	●
	LG-405	●
K & L Frames, Round Butt including Governor	LG-306	●
K & L Frames Round Butt	LG-308	●
K & L Frames Square Butt	LG-307	●
K & L & N Frames Square and Round Butt	LG-207	●
N Frame Round Butt	LG-314	●
MGP full-size .9MM, .357 SIG, .40 S&W, .45 ACP	LG-660	●
MGP compact .9MM, .357 SIG, .40 S&W	LG-661	●
SPRINGFIELD ARMORY		
XD 9MM, .40 S&W, .357 SIG, .45 GAP	LG-446	●
TAURUS		
Models 17, 85, 94, 327 six-shot, 605, 650, 651, 731, 850, 905 and 941. Does not fit models after 2014.	LG-185	●
	LG-385	●
Judge and Tracker	LG-375	●

DEFENDER SERIES™ FEATURES + SPECIFICATIONS



The Defender Series™ line provides Crimson Trace® quality and dependability with an affordable price tag. Utilizing the same powerful laser technology you expect from Crimson Trace®, the Defender Series line offers fits for a myriad of today's most popular brands including: Glock, Ruger, Smith & Wesson, Springfield Armory and Taurus.

PRODUCT



• DS-121
FOR GLOCK FULL-SIZE & COMPACT



• DS-123
FOR SPRINGFIELD ARMORY
XD(M) FULL-SIZE



• DS-124
FOR TAURUS SMALL FRAME

GLOCK		
Third Generation 17, 17L, 19, 20, 20SF, 21, 21SF, 22, 23, 31, 32, 34, 35, 37, 38 Gen4 17, 19, 20, 21, 22, 23, 34, 35 Gen5 17, 19, 19X	DS-121	•
RUGER		
LCP Pistols. Does not fit LCP Gen II Pistols	DS-122	•
SMITH & WESSON		
J Frame Round Butt	DS-124	•
SPRINGFIELD ARMORY		
XD, XD Mod.2 and XD(M) Pistols with modern accessory rail. Does not fit HS2000 or early Croatian XD models with single rail notch	DS-123	•
TAURUS		
Small Frame Revolvers (85, 94, 605, 650, 651, 731, 850, 851, 856, 905, 941) Manufactured prior to 2014	DS-124	•

LIGHTGUARD® FEATURES + SPECIFICATIONS



Lightguard® offers a seamless fit and quality illumination for your preferred carry pistol. Featuring a 95 or 110 peak lumen LED white light, Lightguard® models attach firmly around the trigger guard and provide durable performance and effective illumination. Best-in-class tactical lights from the brand you trust for personal protection optics.

PRODUCT



GLOCK		
Glock 42 and 43	LTG-773	○
Glock 26 and 27	LTG-777	○
RUGER		
LCP II	LTG-778	○
LCP	LTG-779	○
SIG SAUER		
P365	LTG-772	○
P938 and P238	LTG-776	○
SMITH & WESSON		
M&P Shield and M&P Shield M2.0 in 9mm and .40 S&W. Does not fit models with integrated lasers	LTG-770	○
SPRINGFIELD ARMORY		
XD-S 9mm and .40mm	LTG-771	○

RAIL MASTER® CMR-209 FEATURES + SPECIFICATIONS



Introducing the CMR-209 Rail Master® Universal Pistol Light for rail-equipped firearms, a versatile tactical lighting option at an incredible value - from the brand you trust for personal protection optics.

PRODUCT

RAIL EQUIPPED FIREARMS		
Pistols, rifles and shotguns with compatible M1913 Picatinny or Weaver accessory rails	CMR-209	☐



☐ CMR-209 FOR RAIL EQUIPPED FIREARMS

RAIL MASTER® CMR-208 FEATURES + SPECIFICATIONS

LIGHTS



Experience the power that increased illumination can provide to your defensive firearm. Introducing the CMR-208 Rail Master® Universal Tactical Light for rail-equipped firearms; a best-in-class tactical light from the brand you trust for personal protection optics.

PRODUCT

RAIL EQUIPPED FIREARMS		
Pistols, rifles and shotguns with compatible M1913 Picatinny or Weaver accessory rails	CMR-208	○
	CMR-202	○



○ CMR-202 FOR RAIL EQUIPPED FIREARMS

TACTICAL LIGHT FEATURES + SPECIFICATIONS



The Crimson Trace® Tactical Light series is a best-in-class family of handheld and long gun tactical lights. Backed by the Crimson Trace® reputation, our CWL-102 offers tail cap or remote activation in 500 peak lumens. Experience the power that effective illumination can provide.

PRODUCT

RAIL EQUIPPED FIREARMS		
Fits most M1913 Picatinny or similar accessory rails.	CWL-102	○



○ CWL-102 FOR RAIL EQUIPPED FIREARMS

TACTICAL LIGHT FEATURES + SPECIFICATIONS

LIGHTS



The Crimson Trace® Tactical Light series is a best-in-class family of handheld and long gun tactical lights. Backed by the Crimson Trace® reputation, our CWL-202 offers tail cap or remote activation in 900 peak lumens. Experience the power that effective illumination can provide.

PRODUCT



○ CWL-300 HANDHELD TACTICAL FLASHLIGHT

RAIL EQUIPPED FIREARMS		
Fits most M1913 Picatinny or similar accessory rails & M-LOK/KeyMod accessory slots	CWL-202	○
200 Lumens output handheld flashlight	CWL-300	○



○ CWL-202 FOR RAIL EQUIPPED FIREARMS

ELECTRONIC SIGHTS			
CTS-1000	2.0 MOA Compact Red Dot Sight		
CTS-1100	3.5x Battlesight w/ BDC Reticle		
CTS-1300	3.5 MOA Compact Open Reflex Sight		
CTS-1400	3.25 MOA Compact Open Reflex Sight		
RISERS			
CTS-1000	Low Mount		
CTS-1300	Full Co-Witness		
CTS-1400	Full Co-Witness		
CTS-1400	Lower 1/3 Co-Witness		
THROW LEVERS			
CTA-2104/CTA-2416	Fits CTA-2104/2416, includes 1 short and 1 long handle lever + mounting hardware		
CTL-3105	Fits CTL-3105, includes 1 short and 1 long handle lever + mounting hardware		
CTL-5108/CTL-5324/ CSA-3108	Fits CTL-5108/5324/CSA-3108, includes 1 short and 1 long handle lever + mounting hardware		
CSA-2624	Fits CSA-2624, includes 1 short and 1 long handle lever + mounting hardware		
CTL-3525/CTL-3420	Fits CTL-3525/3420, includes 1 short and 1 long handle lever + mounting hardware		
CTL-5318	Fits CTL-5318, includes 1 short and 1 long handle lever + mounting hardware		
FLASHLIGHT			
Handheld		CWL-300	☺
AR & AK TYPE RIFLES			
Fits most M1913 Picatinny or similar accessory rails & M-LOK/KeyMod accessory slots		CWL-102	☺
		CWL-202	☺





RAIL EQUIPPED FIREARMS			
Pistols, rifles and shotguns with M1913 Picatinny or Weaver accessory rails	CMR-201	●	
	CMR-201 CTAN	●	
	CMR-206	●	
	CMR-204	●/○	
	CMR-205	●/○	
	CMR-208	○	
	CMR-209	○	
1911 COMPATIBLE			
1911 Full-Size: 1911 & 1991A1 single-stack full-size frames with grip screws measuring 3 ¹ / ₁₆ " apart	LG-401	●	
	LG-401G	●	
	LG-901 ROSEWOOD	●	
	LG-901G ROSEWOOD	●	
	LG-904 G10 GRAY	●	
	LG-904G G10 GRAY	●	
1911			
1911 Full-Size: 1911 & 1991A1 single-stack full-size frames with grip screws measuring 3 ¹ / ₁₆ " apart	LG-908 WALNUT	●	
	LG-908G WALNUT	●	
	LG-910 G10 GREEN/BLACK	●	
	LG-910G G10 GREEN/BLACK	●	
	LG-919 G10 BLACK	●	
	LG-919G G10 BLACK	●	
	LG-920 COCOBOLO DIAMOND	●	
	LG-920G COCOBOLO DIAMOND	●	
1911 Compact: 1911 single-stack compact frames with grip screws measuring 2 ¹ / ₁₆ " apart	LG-404	●	
	LG-404G	●	
	LG-902 ROSEWOOD	●	
	LG-902G ROSEWOOD	●	
	LG-905 G10 GRAY	●	
	LG-905G G10 GRAY	●	
	LG-909 WALNUT	●	
	LG-909G WALNUT	●	
	LG-911 G10 GREEN/BLACK	●	
	LG-911G G10 GREEN/BLACK	●	
	LG-921 COCOBOLO DIAMOND	●	
	LG-921G COCOBOLO DIAMOND	●	
1911 Bobtail [®] -style, single-stack frames with grip screws measuring 3 ¹ / ₁₆ " apart <small>*Ed Brown Bobtail is a registered trademark of Ed Brown Products, Inc. www.edbrown.com</small>	LG-903 ROSEWOOD	●	
	LG-903G ROSEWOOD	●	
	LG-906 G10 GRAY	●	
	LG-906G G10 GRAY	●	
1911 Round Heel-style, single-stack frames with grip screws measuring 3 ¹ / ₁₆ " apart	LG-907 ROSEWOOD	●	
	LG-907G ROSEWOOD	●	

BERETTA			
Beretta 92 / 96 / M9	LG-402M	●	
Beretta Nano 9mm	LG-483	●	
BERSA			
Bersa Thunder .380 / Firestorm .380	LG-442	●	
Bersa Thunder 380CC	LG-646	●	
BROWNING			
Browning Hi-Power	LG-309	●	
CHARTER ARMS			
Charter Arms Revolvers except Dixie Derringer & South Paw	LG-325	●	
GLOCK			
Glock 42, 43	LG-443	●	
	LG-443G	●	
	LL-803	●/○	
	LL-803G	●/○	
	LTC-773	○	
Glock Third Generation 17, 22, 31, 34, 35, 37; Gen4 17, 22, 31, 34, 35, 37; Gen5 17	LG-637	●	
	LG-637C	●	
GLOCK			
Glock Third Generation 19, 23, 25, 32, 38; Gen4 19, 23, 32; Gen5 19	LG-639	●	
	LG-639G	●	
Glock Third Generation 17, 19, 22, 23, 31, 32, 34, 35, 37, 38	LG-417	●	
Glock Third Generation 26, 27, 28, 33, 39	LG-626	●	
Glock Third Generation 29, 30	LG-629	●	
Glock Third Generation 19, 23, 25, 26, 27, 28, 32, 36, 38, 39; Gen4 19, 23, 26, 27, 32, 33; Gen5 19. Does NOT fit Glock 36 FGR	LG-436	●	
Glock Third Generation 17, 17L, 19, 20, 20SF, 21, 21SF, 22, 23, 31, 32, 34, 35, 37, 38; Gen4 17, 19, 20, 21, 22, 23, 34, 35; and Gen5 17, 19, 19X	DS-121	●	
Glock Third Generation 17, 17L, 19, 22, 23, 24, 25, 31, 32, 34, 35, 37, 38; Gen4 17, 19, 22, 23, 31, 32, 34, 35, 37; Gen5 17, 19, 19x, 45	LL-807	●/○	
	LL-807G	●/○	
Glock Third Generation 26, 27, 33, 36; Gen4 26, 27, 33	LL-810	●/○	
	LL-810G	●/○	
Glock Gen4 26, 27, 33	LG-852	●	
Glock 26 and 27	LTC-777	○	
HECKLER & KOCH			
Heckler & Koch VP9/40 and VP9SK	LG-499	●	
	LG-499G	●	
HONOR DEFENSE			
Honor Defense Honor Guard 9mm	LG-498	●	
KAHR			
Kahr P380, CW380	LG-433	●	
Kahr CW9, CW40, P9, P40, FM9, FM40, TP9, TP40, CT9, CT40, CT45	LG-437	●	
KEL-TEC			
Kel-Tec P3AT, P32 Generations I & II	LG-430	●	
Kel-Tec PF9	LG-435	●	



KIMBER			
Kimber EVO 5P	LG-410	●	
	LG-410G	●	
Kimber Micro .380	LG-478	●	
Kimber Micro 5mm	LG-409	●	
	LG-409G	●	
Kimber KGs	LG-950	●	
	LG-951	●	
	LG-952	●	
MOSSBERG			
Fits most Mossberg 12-gauge 500 series, 590, 590A1 & Shockwave. Models must have receiver that is drilled and tapped. *Does not fit 20-gauge or .410 bore.	LS-250	●	
	LS-250G	●	
REMINGTON			
Remington RM380	LG-479	●	
Remington 870	LS-870	●	
	LS-870G	●	
RUGER			
Ruger LCP	LG-431	●	
	LTC-779	○	
Ruger LCP Pistols. Does not fit LCP Gen II Pistols	DS-122	●	
Ruger LCP II	LG-497	●	
	LG-497G	●	
	LTC-778	○	
Ruger LC9, LC9s, LC380, Ec9s	LG-416	●	
	LG-416G	●	
Ruger LCR & LCRx	LG-415	●	
	LG-415G	●	
Ruger CP100, Super Redhawk, Alaskan	LG-344	●	
Ruger MK II and III	LG-403	●	
Ruger P Series 85, 89, 90, 91, 93, 94 & 944	LG-389	●	
Ruger SP101	LG-111	●	
	LG-303	●	
Ruger SR9C, SR40C Compact	LG-449	●	
SIG SAUER			
Sig Sauer P238 and P938	LG-492	●	
	LG-492G	●	
	LTC-776	○	
Sig Sauer P320, M17, M18. Does not fit subcompact frames.	LG-420	●	
	LG-420G	●	
Sig Sauer P365	LG-422	●	
	LG-422G	●	
	LTC-772	○	
Sig Sauer P220	LG-320	●	
Sig Sauer P226	LG-426	●	
	LG-426M	●	
Sig Sauer P228, P229	LG-429	●	
	LG-429M	●	
Sig Sauer P239	LG-439	●	

SMITH & WESSON			
Smith & Wesson J-Frame Round Butt	LG-105	●	
	LG-305	●	
	LG-350	●	
	LG-350G	●	
	LG-405	●	
	DS-124	●	
Smith & Wesson K & L Frames, Round Butt including Governor	LG-306	●	
Smith & Wesson K & L Frames Round Butt	LG-308	●	
Smith & Wesson K & L Frames Square Butt	LG-307	●	
Smith & Wesson K & L & N Frames Square and Round Butt	LG-207	●	
Smith & Wesson N-Frame Round Butt	LG-314	●	
Smith & Wesson M&P Full-Size .9MM, .357 SIG, .40 S&W, .45 ACP	LG-660	●	
Smith & Wesson M&P Compact .9MM, .357 SIG, .40 S&W	LG-661	●	
Smith & Wesson M&P Full-Size & Compact	LG-360G	●	
Smith & Wesson M&P M2.0 Full-Size & Compact	LG-362	●	
	LG-362G	●	
Smith & Wesson M&P 45 Shield	LG-485	●	
	LG-485G	●	
	LL-808	●/○	
	LL-808G	●/○	
SMITH & WESSON			
Smith & Wesson M&P Shield and M&P Shield M2.0 in 9mm and .40 S&W	LG-489	●	
	LG-489G	●	
	LL-801	●/○	
	LL-801G	●/○	
	LTC-770	○	
Smith & Wesson M&P 380 Shield EZ	LG-459	●	
	LG-459G	●	
Smith & Wesson M&P Bodyguard 380	LG-454	●	
	LG-454G	●	
SPRINGFIELD ARMORY			
Springfield Armory XD-S 9mm and .40mm	LG-469	●	
	LG-469G	●	
	LL-802	●/○	
	LL-802G	●/○	
	LTC-771	○	

ROUND BUTT OR SQUARE BUTT?

All Smith & Wesson revolver frames are either Round or Square Butt. Our grips are precisely designed to fit one or the other. To get the right Lasergrips® model, you'll need to know which type you have. Fortunately, all you have to do is remove your stock grip panels and look at the frame.

REGISTER YOUR PRODUCT

To register your Crimson Trace® product call Customer Service at 800-442-2406 or visit crimsontrace.com.



Springfield Armory XD MOD.2	LG-496	●	
	LG-496G	●	
Springfield Armory XD, XD(M)	LG-448	●	
Springfield Armory XD, XD Mod.2 and XD(M) Pistols with modern accessory rail. Does not fit HS2000 or early Croatian XD models with single rail notch.	DS-123	●	
Springfield Armory XD 9MM, .40 S&W, .357 SIG, .45 GAP	LG-446	●	
	LG-912 G10 BLACK	●	
Springfield Armory EMP	LG-912G G10 BLACK	●	
		●	
TAURUS			
Models 17, 85, 94, 327 six-shot, 605, 650, 651, 731, 850, 905 and 941. Does not fit models after 2014.	LG-185	●	
	LG-385	●	
Taurus Judge and Tracker	LG-375	●	
Taurus Slim 709 and 710	LG-447	●	
Taurus TCP 738 .380	LG-407	●	
Taurus Millennium Pro	LG-493	●	
Taurus Small Frame Revolvers (85, 94, 605, 650, 651, 731, 850, 851, 856, 905, 941)	DS-124	●	
WALTHER			
Walther PPS M2	LG-482	●	
	LG-482G	●	





®



LASERLYTE

MBS-1

L01-00006 UPC - 689706210564 Case Pack: 6

- ▶ Easily sight-in scopes, iron sights or laser sights
- ▶ Fits caliber .22-.50 (Min 3" barrel)
- ▶ Save time, money and ammo
- ▶ Batteries, hardware and all adapters included
- ▶ Material: aluminum

Quickly and easily sight-in your iron sights, laser sights or optics without going to the range or live fire. Save time, money and ammo with this must have Laser Bore Sight.

Universal Laser Bore Sight



MBS-DLUH

L01-00026 UPC - 689706211950 Case Pack: 6

- ▶ Fits .22 to .50 caliber and 12 & 20 gauge shotguns
- ▶ Sight-in firearms with ease
- ▶ Save time, money and ammo
- ▶ Includes Universal Laser Bore Sight

Universal kit includes the Laser Bore Sight and all adapters to fit almost every caliber. Quickly and easily sight-in your iron sights, laser sights or optics without going to the range or live fire. Save time, money and ammo with this complete kit.

Laser Bore Sight Deluxe Kit



MBS-PAH

L01-00027 UPC - 689706210586 Case Pack: 6

- ▶ Fits .22 to .50 caliber and 12 & 20 gauge shotguns
- ▶ Sight-in firearms with ease
- ▶ Save time, money and ammo
- ▶ Universal Laser Bore Sight Not Included

Accessory Kit includes adapters to fit almost every caliber to maximize the use of your Laser Bore Sight. Quickly and easily sight-in your iron sights, laser sights or optics without going to the range or live fire. Save time, money and ammo with this kit.

Laser Bore Sight Accessory Kit



CB-L368

L01-00024 UPC - 689706212117 Case Pack: 6

Laser Bore Sight Cartridge Kit (Rifle)

- ▶ Fits .223, .25-06, .270, .30-06, .243, .308, 7mm-08, .260
- ▶ Easily drops into the chamber for fast sight-in
- ▶ Excellent use for target practice and trigger discipline
- ▶ Laser alignment for accurate sight-in of scopes, red dots, iron sights or laser sights
- ▶ Material: machined brass housing is designed to be extremely accurate and not harm the firearm's chamber

Quickly and easily sight-in your iron sights, laser sights or optics without going to the range or live fire. Drop the caliber cartridge into the chamber of your firearm to save time, money and ammo.



LASER BORE SIGHT CARTRIDGES & REPLACEMENT PARTS HITS

Quickly and easily sight-in your iron sights, laser sights or optics without going to the range or live fire. Drop the caliber cartridge into the chamber of your firearm to save time, money and ammo.

CARTRIDGES

- ▶ Easily drops into the chamber for fast sight-in
- ▶ Excellent use for target practice and trigger discipline
- ▶ Laser alignment for accurate sight-in of scopes, red dots, iron sights or laser sights
- ▶ Material: machined brass housing is designed to be extremely accurate and not harm the firearm's chamber

LT-223	L01-00001	223 Laser Bore Cartridge	UPC - 689706211172	Case Pack 6
LT-380	L01-00002	380 Laser Bore Cartridge	UPC - 689706210601	Case Pack 6
LT-40	L01-00003	40 Laser Bore Cartridge	UPC - 689706210281	Case Pack 6
LT-45	L01-00004	45 Laser Bore Cartridge	UPC - 689706210298	Case Pack 6
LT-9	L01-00005	9mm Laser Bore Cartridge	UPC - 689706210274	Case Pack 6

REPLACEMENT KITS

- ▶ Replacement parts and batteries for Laser Cartridges
- ▶ Includes the switch, extra O-rings, and 12 extra 377 batteries

6K-LT-380	L01-00010	380 Laser Bore Parts	UPC - 689706212155	Case Pack 6
6K-LT-40	L01-00011	40 Laser Bore Parts	UPC - 689706212131	Case Pack 6
6K-LT-45	L01-00012	45 Laser Bore Parts	UPC - 689706212148	Case Pack 6
6K-LT-223	L01-00009	223 Laser Bore Parts	UPC - 689706212162	Case Pack 6
6K-LT-9	L01-00013	9mm Laser Bore Parts	UPC - 689706212124	Case Pack 6



LT-PRE

L01-00025 UPC - 689706211639 Case Pack 6

- ▶ Fits .380 ACP, 9mm, .40 S&W, .45 ACP (Min 1.85" barrel)
- ▶ Fits most snub-nosed revolvers
- ▶ No ammo required
- ▶ Increase accuracy
- ▶ Train anywhere

Laser Trainer Premium



Save time and money while training in the comfort of your own home. Compatible with almost any caliber, the laser trainer premium is ready to train when you are.



TRIGGER TYME[®]

- ▶ Full-size, compact and revolver
- ▶ For use with LaserLyte™ Laser Trainer Targets
- ▶ No ammo required
- ▶ Increase accuracy
- ▶ 5.5 lb. realistic trigger pull
- ▶ Realistic feel, balance and weight

Laser Trainer Pistol



Train at home, save time on trips to the range, save money on ammo and gas. Line up the sights, pull the trigger. The realistic 5.5 lb trigger and familiar weight and balance feels like a real firearm. There is no such thing as too much training. The Laser Trainer Pistol gives you the option to train anytime and anywhere. Use with any LaserLyte Targets.



LT-TTL L01-00007 Full Size Laser Trainer Pistol
 LT-TTLC L01-00008 Compact Laser Trainer Pistol
 LT-TT86 L01-00023 Revolver Laser Trainer Pistol

UPC - 689706211479 Case Pack 6
 UPC - 689706211498 Case Pack 6
 UPC - 689706211721 Case Pack 6

TLB-LQD

L01-00030 UPC - 689706211783 Case Pack 6

Quick Tyme® Laser Trainer Kit

- ▶ Includes (1) Quick Tyme® Laser Trainer Target and (1) Trigger Tyme® Laser Trainer Full Size Pistol
- ▶ No ammo required
- ▶ Increase accuracy
- ▶ 5.5 lb. realistic trigger pull and familiar weight to an actual pistol
- ▶ Easy to set up target with built in shot timer

Test your speed and accuracy. Train at home, save time on trips to the range, save money on ammo and gas. Line up the sights and pull the trigger. The realistic 5.5 lb trigger and familiar weight and balance feels like a real firearm and the Quick Tyme target provides immediate feedback. Test your skills while increasing your speed and accuracy.



TLB-PQD

L01-00036 UPC - 689706212193 Case Pack 6

Quick Tyme® Universal Laser Trainer Kit

- ▶ Includes (1) Quick Tyme® Laser Trainer Target and (1) Premium Laser Trainer
- ▶ No ammo required
- ▶ Increase accuracy
- ▶ Universal fit for your firearm
- ▶ Easy to set up target with built in shot timer

The laser trainer will show you how fast you are with your own pistol. The laser trainer is sound activated and will fire a red laser dot. The laser trainer easily adjusts to fit most pistol calibers including .380 ACP, 9mm, .40 and .45.



TLB-PHL

L01-00040 UPC - 089705212209 Case Pack: 0

Score Tyme® Universal Laser Trainer Kit

- ▶ Includes (1) Score Tyme® Laser Trainer Target and (1) Premium Laser Trainer
- ▶ No ammo required
- ▶ Increase accuracy
- ▶ Universal fit for your firearm
- ▶ Easy to set up target with built in shot timer

The laser trainer will show you how good you are with your own pistol. The laser trainer is sound activated and will fire a red laser dot. The laser trainer easily adjusts to fit most pistol calibers including .380 ACP, 9mm, .40 and .45.



TLB-LMS

TLB-LMS L01-00028 Steel Tyme® Laser Trainer Targets Kit
 TLB-MDS L01-00033 2 Pack Steel Tyme® Targets

- ▶ Includes (2) Steel Tyme® Laser Trainer Targets and (1) Trigger Tyme® Laser Trainer Compact Size Pistol
- ▶ Easy to set up targets that ping to confirm shots

2 Pack Steel Tyme® Targets

- ▶ Includes (2) Steel Tyme® Laser Trainer Targets
- ▶ Easy to set up targets that ping to confirm shots

Test yourself with these laser trainer targets. Tracking number of hits and shot placements these targets give you real feedback and the rewarding sounds of hitting real steel. Use with the compact Trigger Tyme Laser Trainer Pistol to have fun and enjoy training in the comfort of your own home.

Steel Tyme® Laser Trainer Targets Kit

UPC - 689706211806 Case Pack 6
 UPC - 689706211837 Case Pack 6



TLB-LPT

TLB-LPT L01-00029 Popper Tyme™ Laser Trainer Targets Kit
 TLB-PT L01-00034 2 Pack Popper Tyme™ Laser Targets

- ▶ Includes (2) Popper Tyme™ Laser Trainer Targets and (1) Trigger Tyme® Laser Trainer Compact Size Pistol
- ▶ Easy to set up targets that light up and make sound to confirm shots

2 Pack Steel Tyme® Targets

- ▶ Includes (2) Popper Tyme™ Laser Trainer Targets
- ▶ Easy to set up targets that light up and make sound to confirm shots

This set of 2 Popper Tyme™ laser training targets will provide hours of fun. Every time they are shot they will rotate, flash LEDs and make the sound of shooting steel. There is also a quiet mode that will only flash the LED lights when shot. Use with the compact Trigger Tyme Laser Trainer Pistol to have fun and enjoy training in the comfort of your own home.

Popper Tyme™ Laser Trainer Targets Kit

UPC - 689706212261 Case Pack 6
 UPC - 689706212285 Case Pack 6



TLB-LVS

L01-00032 UPC - 689706211822 Case Pack 6

Score Tyme® Versus Laser Trainer Target Kit

- ▶ Includes (1) Score Tyme® Laser Trainer Target, (1) Trigger Tyme® Laser Trainer Compact Size Pistol and (1) Trigger Tyme® Laser Trainer Full Size Pistol
- ▶ Easy to set up target that lights up and makes sound to confirm shots



Test yourself with this laser trainer target. Tracking number of hits, shot placement, and order, this target allows you to train at home and save money and ammo. Use with Trigger Tyme Laser Trainer Pistols to have fun and enjoy training in the comfort of your own home.

TLB-HL

L01-00037 UPC - 689706211490 Case Pack 6

Score Tyme® Laser Trainer Target

- ▶ Includes Score Tyme® Laser Trainer Targets
- ▶ Easy to set up target that lights up and makes sound to confirm shots

Test yourself with this laser trainer target. Tracking number of hits, shot placement, and order, this target allows you to train at home and save money and ammo. Use with Trigger Tyme® Laser Trainer Pistols to have fun and enjoy training in the comfort of your own home.



TLB-00M

L61-00035 UPC - 689706211820 Case Pack 8

- ▶ Includes Quick Tyme® Laser Trainer Target
- ▶ Easy to set up target that lights up and makes sound to confirm shots

Test yourself with this laser trainer target. Tracking number of hits, shot placement, and order, this target allows you to train at home and save money and ammo. Use with Trigger Tyme® Laser Trainer Pistols to have fun and enjoy training in the comfort of your own home.

Quick Tyme® Laser Trainer Target



UTA-FSL

L61-00016 UPC - 689706211860 Case Pack 8

- ▶ Fits any full size or compact pistol with a Picatinny rail
- ▶ Quick and easy installation
- ▶ Works with any LaserLyte™ Laser Trainer System
- ▶ Includes two interchangeable shells for a custom fit
- ▶ Modes: Constant, Pulse, Training

Laser Sight Trainer – Universal



It is a laser sight, it is a laser trainer, it is all-in-one on your gun. The kit comes with two different size housings for a custom fit. The laser gun sight will put you accurately on target and adjusts to the point of impact. The constant dot mode or flashing dot mode is programmable to the shooter's needs. The auto-off feature will turn the laser off after 8 minutes to save battery life. The sound-activated laser trainer flashes the laser for 1/10th of a second. Train at home with the comfort of your favorite couch and air conditioning saving time on trips to the range and ammo.

UTA-JR

L01-00018 UPC - 689706212216 Case Pack: 6

- ▶ Fits SCCY CPX-1, 2 9mm
- ▶ Quick and easy installation
- ▶ Works with any LaserLyte™ Laser Trainer Systems
- ▶ Includes 3 interchangeable shells for a custom fit
Teal, Grey, Purple
- ▶ Modes: Constant, Pulse, Training

It is a laser sight, it is a laser trainer, it is all-in-one on your gun. The kit comes with two different size housings for a custom fit. The laser gun sight will put you accurately on target and adjusts to the point of impact. The constant dot mode or flashing dot mode is programmable to the shooter's needs. The auto-off feature will turn the laser off after 6 minutes to save battery life. The sound-activated laser trainer flashes the laser for 1/10th of a second. Train at home with the comfort of your favorite couch and air conditioning saving time on trips to the range and ammo.

Laser Sight Trainer – SCCY CPX



UTA-FR

L01-00015 UPC - 689706211301 Case Pack: 6

- ▶ Fits SCCY CPX-1, 2 9mm
- ▶ Quick and easy installation
- ▶ Works with any LaserLyte™ Laser Trainer Systems
- ▶ Includes 3 interchangeable shells for a custom fit
Black, Tan and Pink
- ▶ Modes: Constant, Pulse, Training

It is a laser sight, it is a laser trainer, it is all-in-one on your gun. The kit comes with two different size housings for a custom fit. The laser gun sight will put you accurately on target and adjusts to the point of impact. The constant dot mode or flashing dot mode is programmable to the shooter's needs. The auto-off feature will turn the laser off after 6 minutes to save battery life. The sound-activated laser trainer flashes the laser for 1/10th of a second. Train at home with the comfort of your favorite couch and air conditioning saving time on trips to the range and ammo.

Laser Sight Trainer – SCCY CPX



LASER SIGHT TRAINER

UTA-HAB	L01-00017	Hi-Point® 9mm, .380 ACP, 40 S&W&S, 45ACP	UPC - 688706211547	Case Pack 6
UTA-M2	L01-00019	Walther® PPS M1, M2 or pistols with picatinny/weaver accessory rail	UPC - 688706211779	Case Pack 6
UTA-TA	L01-00020	Taurus® 738 TCP & 709/749 SLM	UPC - 688706211288	Case Pack 8
UTA-LYL	L01-00021	Ruger® LCP, LCR, LC(s) and LC380	UPC - 688706211707	Case Pack 6
UTA-YY	L01-00022	Glock® G269, G278, G426, G436 and all generations	UPC - 688706211431	Case Pack 8

- ▶ Quick and easy installation
- ▶ Works with any LaserLyte™ Laser Trainer Systems
- ▶ Includes two interchangeable shells for a custom fit
- ▶ Modes: Constant, Pulse, Training

It is a laser sight, it is a laser trainer, it is all-in-one on your gun. The kit comes with two different size housings for a custom fit. The laser gun sight will put you accurately on target and adjusts to the point of impact. The constant dot mode or flashing dot mode is programmable to the shooter's needs. The auto-off feature will turn the laser off after 6 minutes to save battery life. The sound-activated laser trainer flashes the laser for 1/10th of a second. Train at home with the comfort of your favorite couch and air conditioning saving time on trips to the range and ammo.



2021 NEW PRODUCTS

LOCKDOWN[®]





WHO WE ARE

Lockdown is the brand you trust for your vault needs. Organization, lighting, moisture control and security have been our focus since 2010. Today we take it to the next level and bring smart products together with firearm security through our Logic products.

With one easy-to-use app you can control all of our LOGIC Products. Stay safe from intruders and the elements with open door sensors, motion detection, temperature and humidity monitoring and so much more. From your vault to your front door, Lockdown has you covered.

SECURE
your lifestyle™

LOGIC™ VAULT DOOR

- WiFi Enabled
- Open Sensor
- Vibration Sensor
- Monitor Temp/Humidity on Inside of Door
- Audible Alerts
- Push Notifications
- Touch Keypad With Temp & Humidity Display
- Multiple Access Codes
- Motorized Locking/Unlocking

PATS:
WWW.AGG.COM/PATENTS

28/30", LH, Out Swing
28/30", RH, Out Swing
30/32", LH, In Swing
30/32", RH, In Swing

SKU 1118815
SKU 1118816
SKU 1118817
SKU 1118818

UPC 661120080602
UPC 661120080596
UPC 661120080589
UPC 661120080572

CASE PACK 1
CASE PACK 1
CASE PACK 1
CASE PACK 1

PACKAGE Drop Ship/custom pallet
PACKAGE Drop Ship/custom pallet
PACKAGE Drop Ship/custom pallet
PACKAGE Drop Ship/custom pallet

- Locking System that Resists over 500,000 lbs. of Shear Force
- Bullet Proof Drill Plate
- 12v Power with Battery Power Backup
- Fits Standard 2x4 Construction Walls
- Optional Pairing with Other LOGIC™ Products



Ultra strong anti-pry handle automatically recedes into the door when closed.



LOGIC **ENABLED**™

LOGIC™ BUNKER DOOR

- WiFi Enabled
- Open Sensor
- Vibration Sensor
- Monitor Temp/Humidity on Inside of Door
- Audible Alerts
- Push Notifications
- Touch Keypad With Temp & Humidity Display
- Multiple Access Codes
- Motorized Locking/Unlocking

PATS:
WWW.AGG.COM/PATENTS

36", LH, In Swing
36", RH, In Swing

SKU 1118819
SKU 1118820

UPC 661120080565
UPC 661120080558

CASE PACK 1
CASE PACK 1

PACKAGE Drop Ship/custom pallet
PACKAGE Drop Ship/custom pallet

- Locking System that Resists over 500,000 lbs. of Shear Force
- Bullet Proof Drill Plate
- Fire Rated
- 12v Power with Battery Power Backup
- Fits 8" or thicker Concrete Walls
- Optional Pairing with Other LOGIC™ Products



Ultra strong anti-pry handle automatically recedes into the door when closed.



LOGIC **ENABLED**™



LOGIC **ENABLED**

LOGIC™ PLUG

- Wi-Fi Enabled
- Manual ON/OFF
- Set Schedules
- Monitor Usage
- Set Timers

- 120 Volt 10amp
- Compact Design Fits 2 Plugs per Outlet
- Google Home & Amazon Alexa Integration
- Optional Pairing with Other LOGIC™ Products



Secure your lifestyle™ with the LOGIC ecosystem. Use the Plug with our LOGIC products to trigger actions.

LOGIC™ PLUG SKU 117246 UPC 661120103189 CASE PACK 6 PACKAGE Hanging Box 4.25" x 4" x 2.25"

LOGIC™ SECURE CAMERA

- Wi-Fi Enabled
- Records/Streams Live Video
- Motion Activated
- 2-Way Audio
- Local and Cloud Based Storage

- Push Notifications
- USB Power
- 1080p Resolution, 15fps, 100° Viewing Angle, 8m IR Range
- Optional Pairing with Other LOGIC™ Products

PATS:
www.aob.com/pats

Keep your home as secure as you keep your firearms. Receive notifications when motion is detected and access a live video stream in the palm of your hand.



LOGIC **ENABLED**

LOGIC™ CAMERA SKU 1122183 UPC 661120080633 CASE PACK 4 PACKAGE Hanging Box 6" x 5" x 1.5"
 PRO KIT SKU 1099417 UPC 661120416982 CASE PACK 2 PACKAGE Hanging Box TBD
 (Includes PLUG, PLUG, CAMERA)

COMBINATION HANDGUN VAULT - COMPACT

- Resetttable Combination Lock
- All Steel Construction
- Meets TSA Airline Requirements
- 5.6" x 8.3" x 1.8" Inside Dimensions
- California DOJ Certified
- Fits Most Compact & Subcompact Handguns

DOJ Certified **Secure** storage for compact handguns at home or traveling.



COMBINATION HANDGUN VAULT - COMPACT SKU 1134158 UPC 661120104636 CASE PACK 6 PACKAGE Hanging Box 9.1" x 6.1" x 2.6"

COMBINATION HANDGUN VAULT - LARGE

- Resetttable Combination Lock
- All Steel Construction
- Meets TSA Airline Requirements
- 6.3" x 10" x 1.8" Inside Dimensions
- California DOJ Certified
- Puck Compatible (Lockdown Puck® not included)
- Ideal for Full Size Handguns

DOJ Certified **Secure** storage for fullsize handguns at home or traveling.



COMBINATION HANDGUN VAULT - LARGE SKU 1134157 UPC 661120104643 CASE PACK 6 PACKAGE Hanging Box 10.8" x 6.8" x 2.6"

RECHARGEABLE SILICA GEL - 5 PACK

- Absorbs Moisture from the Air
- Recharges in the Oven
- Individually Wrapped 40 Gram Silica Bags
- Changes from Orange to Blue when Recharge is Needed
- Ideal for Handgun Vaults, Ammo Cans & Gun Cases

Remove moisture from the air again and again to protect your valuables.



RECHARGEABLE SILICA GEL - 5 PACK SKU 1138993 UPC 661120104742 CASE PACK 4 PACKAGE Hanging Box 5.1" x 4.3" x 2.9"











LOCKDOWN[®]
SECURE
your lifestyle[™]

returning products

The Lockdown Puck™ utilizes state-of-the-art sensors and our proprietary algorithm to detect tampering and notify you instantly anywhere in the world. The built-in Wi-Fi and Lockdown Logic™ App connects directly with your smart home and other Lockdown™ Devices. From protecting guns and ammo to your family heirlooms, you can trust the Lockdown Puck™ to keep your valuables safe and secure.



-  Connected
-  Audible alerts
-  Tamper/Impact sensor
-  Monitor Temp/Humidity
-  Pairs with LOCKDOWN LOGIC™ App
-  Door sensor
-  Push notifications
-  USB power
(9ft. usb/micro usb power cord included)
-  Optional battery power
(4 AA batteries included)



Magnetic Door Sensor: Mount the Puck to any door and the magnetic sensor will detect when it opens and closes



Hanging Box Size: 4.75" w x 5.75" h x 2.5" d

CASE PACK: 4

INCLUDES: 1 PUCK™ Unit, 1 - 3 meter long Micro USB power cord, 1 magnetic door sensor, 1 mounting bracket and hardware, 4 AA batteries, 1 secured lifestyle

 **PATS:**
WWW.AQ9.COM/PATENTS

#1099416 PUCK

UPC 661120417057

Keep your valuables protected from the damaging effects of temperature and humidity with Lockdown® Hygrometers. The state of the art technology shows the current conditions and even records the historical max. and min. values. Use the Wireless Hygrometer with Remote Sensor to keep an eye on conditions inside a vault or cabinet.

WIRELESS DIGITAL HYGROMETER



WIRELESS

Monitor temperature from base unit and remote



Monitor humidity from base unit and remote



Record Min/Max values from base unit and remote



Wireless connection



Illuminated screen



Magnetic mounting option



Battery power (AAA batteries included)



Remote displays current humidity & temperature



Mount with a hook, the included magnets or free standing using the kick stand.

#1116792

WIRELESS DIG. HYGROMETER

UPC 661120080619

Hanging Box Size: 4.75" w x 6.1" h x 1.5" d

CASE PACK: 6

INCLUDES: 1 Digital Hygrometer Unit, 4 AAA batteries, 1 secured lifestyle

DIGITAL HYGROMETER

Keep your valuables protected from the damaging effects of temperature and humidity with Lockdown® Hygrometers. The state of the art technology shows the current conditions and even records the historical max. and min. values. Use the Digital Hygrometer to keep an eye on conditions inside a vault or cabinet.



Monitor temperature



Monitor humidity



Record Min/Max values



Illuminated screen



Magnetic mounting option



Battery power
(AAA batteries included)



Mount with a hook, the included magnets or free standing using the kick stand.



Hanging Box Size: 4" w x 4.25" h x 1.3" d

CASE PACK: 6

INCLUDES: 1 Digital Hygrometer Unit, 2 AAA batteries, 1 secured lifestyle

#1116774

DIGITAL HYGROMETER

UPC 661120080626

AUTOMATIC DEHUMIDIFIER

The Lockdown® Automatic Dehumidifier is the ultimate in humidity protection. It removes moisture directly out of the air using an ultra-efficient thermo-electric process. Water drains into a holding tank or directly to your drain with the built-in hose connection. Best of all, the Automatic Digital Control turns the unit on only when the humidity gets high and turns it off when it's back under control.

Set humidity thresholds and the Dehumidifier will automatically monitor and maintain the levels. Set it and let it work.



Automatic humidity control;
Set desired humidity level



Ideal for small to medium sized rooms.
400mL per day of moisture removal



Easy to see digital control panel



1.5L tank capacity



Included extended length drainage hose
for worry free dehumidification



Full float sensor automatically stops
Dehumidifier when tank is full



AC power with US and CE plugs



Drain hose connects
to back of tank



#1117251 Automatic Dehumidifier UPC 661120080527

Box Size: 9" w x 13" h x 6.75" d

CASE PACK: 2

INCLUDES: 1 Dehumidifier Unit, drainage hose,
AC/European power cord adapters,
1 secured lifestyle

COMPACT AUTOMATIC DEHUMIDIFIER

The Lockdown® Compact Automatic Dehumidifier is the ultimate in humidity protection. It removes moisture directly out of the air using an ultra-efficient thermo-electric process. Water drains into a holding tank or directly to your drain with the built-in hose connection. Best of all, the Automatic Digital Control turns the unit on only when the humidity gets high and turns it off when it's back under control.



Automatic humidity control;
Set desired humidity level



Ideal for vaults and closets.
250mL per day of moisture removal



Easy to see digital control panel



600/ml tank capacity



Included extended length drainage hose
for worry free dehumidification



Full float sensor automatically stops
Dehumidifier when tank is full



AC power with US and CE plugs



Set humidity thresholds and the Compact Dehumidifier
will automatically monitor and maintain the levels.
Set it and let it work.



Removable
tank



Drain hose connects to
back of tank

Box Size: 6.25" w x 11" h x 5.5" d

CASE PACK: 4

INCLUDES: 1 Dehumidifier Unit, drainage hose,
AC/European power cord adapters,
1 secured lifestyle

#1117252

Compact Dehumidifier

UPC 661120080510

TRIGGER LOCKS

Keep other trigger fingers away from your guns with the Lockdown® Trigger Locks. Keyed and Combination Versions let you pick your protection style and the California Department of Justice Certification give you peace of mind that your guns are always Locked Down.

3 Available in
PACK



Programmable combinations
or key lock option



Heavy-duty bolt secures
through trigger guard



Key lock trigger guard comes
with 2 keys per lock



Rubberized pads help protect firearms



California DOJ certified



#1118824

Key Lock Single

UPC 661120080701

#1118825

Key Lock 3-Pack

UPC 661120080718

#1118826

Combo Lock Single

UPC 661120080725

Single Blister Size: 4" w x 6" h x 3" d

3-Pack Blister Size: 4" w x 10" h x 3" d

CASE PACK: 10

IN-PLAIN-SIGHT SHELVES

Hide your most important stuff In-Plain-Sight with the Lockdown® In Plain Sight Shelf. We combined high-quality wooden construction with a secret magnetic latch that opens a hidden compartment. The Built-in LED light will even let you access it in total darkness, plus the shelf is compatible with other Lockdown® smart products like the LOCKDOWN Puck™, so be sure to Puck your shelf.

 Customizable peg system secures and organizes your firearms and valuables

 Hidden magnetic latch for quick and secure opening

 Automatic internal LED light

 Hydraulic "soft drop" opening

 20lb. Max weight rating

 Integrated Puck™ mounting location (LOCKDOWN Puck™ not included)



 Customizable peg mounting system

LOCK ACCESS MAGNET:

The I.P.S. shelves have hidden magnetic locks. Place the magnet in the correct location and tap the bottom of the shelf to quickly access your valuables



Available in
Dark Walnut in solid wood
White in MDF

Shelf dimensions: 24" wide x 12" deep x 3.25" thick

Box Size: 24.5" w x 12.5" h x 4" d

CASE PACK: 2

INCLUDES: In Plain Sight Shelf, 1 Lock access magnet, Mounting hardware, two CR2032 batteries, 8 peg mounts, 1 secured lifestyle

#1117247

White I.P.S. Shelf

UPC 661120080541

#1117248

Dark Walnut I.P.S. Shelf

UPC 661120080534

 **PATENTS:**
WWW.AGB.COM/PATENTS

MAGNUM MAGNET™ #1097608

Box Size: 5"W x 5.5"H x 1"D Case Pack: 5

- Holds up to 75 lbs.
- Extra-large magnetic surface
- Holds multiple handguns or a long gun in any orientation
- Includes mounting screws



holds up to 75 lbs.



MAGAZINE MAGNET #1097609

Box Size: 5"W x 14"H x 0.75"D Case Pack: 10

- Extra-strong magnet holds even fully loaded magazines
- Holds up to 14 fully loaded steel Double-Stack magazines
- Holds fully loaded magazines
- Holds large steel rifle caliber loaded magazines
- Self-adhesive backing for easy installation
- Includes self-tapping screws for installation on carpeted safe walls



Holds up to 15 fully loaded magazines



15" CABLE GUN LOCK #110149

Box Size: 2.8"W x 6"H x 1"D Case Pack: 6

- Hi-visibility green for instant verification
- 15" reinforced cable
- 30mm keyed padlock
- Includes 2 keys



RECHARGEABLE DEHUMIDIFIER #1092878

Box Size: 5"W X 9.2"H X 3"D Case Pack: 4

- Water Glass Crystals absorb moisture, are odorless, non-toxic and will not release moisture back into the air
- Compact design fits nearly anywhere
- Indicator window shows when unit needs recharging
- Protects up to 333 cu. ft.
- Includes charging cord and recharges in ~12 hours

Indicator window lets you know when you need to recharge the crystals



Usable anywhere, recharge when needed



SILICONE GUN SOCKS

Case Pack: 10

- 100% polyester material will not absorb moisture
- Silicone treated fabric repels moisture to help prevent against rust.
- Protects against scrapes and damage in storage
- Available in four sizes to fit nearly any firearm

Product	Dims	Item #
Pistol Gun Sock	4" x 14"	#1099390
Bag size: 5"W x 7.5"H x 1"D		
Shotgun/Rifle Gun Sock	4" x 54"	#1099391
Bag size: 5"W x 10"H x 1.5"D		
Scoped Rifle Gun Sock	6" x 48"	#1099392
Bag size: 6.5"W x 11"H x 1"D		
Tactical Rifle Gun Sock	6" x 36"	#1099393
Bag size: 6.5"W x 9"H x 1"D		

Helps prevent the formation of rust and provides protection in storage

Draw string cinch top



Elastic fabric hugs firearms



GUN CONCEALMENT MAGNET #222501

Clam Size: 5"W x 6.5"H x 1.5"D Case Pack: 5

- Mounts securely vertically or horizontally, at an angle or upside down
- Magnet works on most handguns with metal slide or barrel
- Holds shotguns or rifles with additional magnet

INCLUDES

- (2) wood screws
- (2) drywall screws with anchors

USE TWO TO
SUSPEND RIFLES
OR SHOTGUNS



1.5"W x 4.625"H x 0.5"D

UNDER DESK HOLSTER #110125

Clam Size: 9.8"W x 13.5"H x .25"D Case Pack: 6

- Ambidextrous
- Made of nylon with reinforced backing for rigidity
- 4.25" wide elastic holster holds handguns from compact semi-automatics to full frame revolvers

INCLUDES

- (4) mounting screws



NIGHT GUARDIAN® HOLSTER

Long Gun Holster (Set of 2) #222503

Clam Size: 6.5"W x 18.5"H x 4.5"D Case Pack: 5

SET OF 2
SUSPENDS RIFLES
OR SHOTGUNS

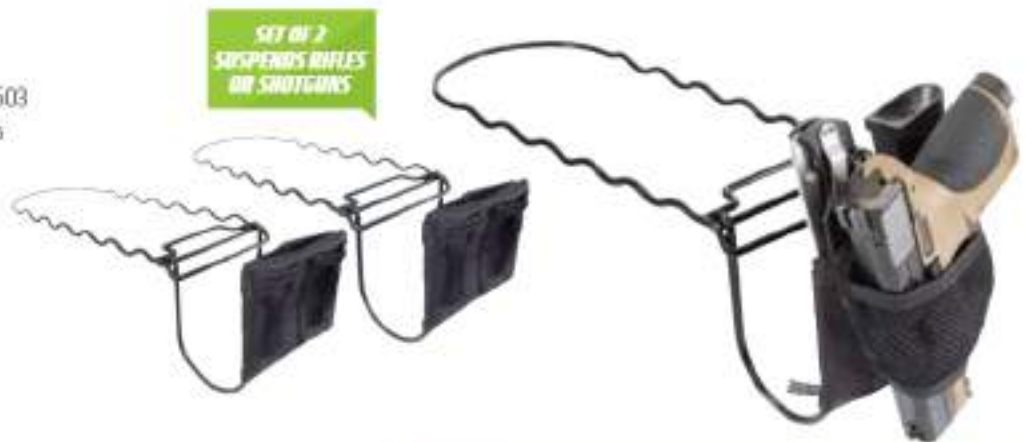

- Ambidextrous
- Universal holster for any size pistol or revolver
- Universal pouches for single or double stack magazines and most flashlights
- Conceals firearm from view under comforter
- Vinyl-coated steel frame keeps holster in place while drawing the firearm

Product is NOT intended to prevent or protect from unauthorized use



HANDGUN VAULTS

Ultra Compact #1082265

Box Size: 5.5"W x 7.16"H x 2.3"D Case Pack: 6

Compact #1082264

Box Size: 6.1"W x 9.2"H x 2.3"D Case Pack: 6

Large #1082263

Box Size: 6.9"W x 10.6"H x 2.3"D Case Pack: 6

- 19-gauge walls with additional 16-gauge side and bottom reinforcement plate
- Meets TSA airline requirements
- Approved by the California Department of Justice
- Key-lock

INCLUDES

- (2) keys



CALIFORNIA
D.O.J.
APPROVED!

Inside dimensions:
6.5"W x 5.1"H x 1.6"D

Inside dimensions:
5.625"W x 8.25"H x 1.75"D

Inside dimensions:
6.5"W x 10"H x 1.75"D



SUPER MAX

KEYED LOCK VAULT #222620

Box Size: 13.5"W x 8.5"H x 3.5"D Case Pack: 4

- Keyed vault with dual locking bolts
- 16-gauge steel construction
- LED light inside vault
- Holds barrel lengths up to 6"

INCLUDES

- (2) keys



Inside dimensions: 12"W x 7.75"H

SUPER MAX™ READY VAULT #222933

Box Size: 13.5"W x 8.5"H x 3.5"D Case Pack: 4

- 1,000+ lock combinations
- 5-button mechanical lock, EMP proof
- Mountable from top, left or right sides
- LED light inside vault
- Holds barrel lengths up to 6"

INCLUDES

- Mounting hardware



LED VAULT TAPE LIGHT #1077070

Box Size: 5.7"W x 7.7"H x 1.6"D Case Pack: 5

- Motion sensor activation with adjustable time delay
- Mounts to any surface (carpet, steel, wood, etc.)
- 3 meters of ultra-bright white LEDs
- 1 meter of power cord
- Cut-to-length capability
- 3M adhesive backer
- 1,200 lumen output

INCLUDES

- 110v AC plug and 2m extension cord
- Mounting tabs with screws



CORDLESS 75-LED VAULT LIGHT #222009

Box Size: 4.25"W x 11"H x 1"D Case Pack: 5

- 95 lumen output
- Strong magnet or screw attachment
- 5-hour continuous runtime
- Battery operated (3 AAA batteries not included)
- Mounts easily with attached magnet or included screws



CORDLESS 25-LED VAULT LIGHT (2-PACK) #222008

Box Size: 4.25"W x 11"H x 1"D Case Pack: 5

- Auto ON/OFF sensor
- 70 lumen output
- Battery operated (3 AAA batteries not included)
- 6-hour continuous runtime; 8,700-hour stand by per light
- Mounts easily with attached magnet or included screws



A. SILICA GEL CAN (750G) #222178

Box Size: 4.5"W x 6.5"H x 4.5"D Case Pack: 4

B. SILICA GEL BAG (450G) #222179

Box Size: 5"W x 7"H x 2"D Case Pack: 6

C. SILICA GEL CAN (40G) #222555

Clam Size: 3.5"W x 8.5"H x 1"D Case Pack: 6

- Absorbs moisture from the air
- Easily recharged in an oven
- 750g Can provides protection for up to 57 cubic feet
- 450g Bag provides protection for up to 33 cubic feet
- 40g Can ideal for small handgun vaults or gun cases



Needs Recharging



Fully Recharged



HYGROMETER #222111

Clam Size: 4.25"W x 7.25"H x 1.25"D Case Pack: 4

- Mounts easily with included fastener or hook and loop pad
- Large, easy-to-read numbers



WIRELESS HYGROMETER #222532

Clam Size: 6.7"W x 7"H x 1.5"D Case Pack: 4



- Check humidity without opening gun vault
- Displays humidity levels from 20%-90%
- Kickout stand or magnetic back rests base on top of safe or securely on vault door
- Battery operated (2 AA not included)



DEHUMIDIFIER RODS

12" Dehumidifier Rod #1071006

220v 12" Dehumidifier Rod #222666



Box Size: 3.4"W x 14"H x 1"D Case Pack: 4

18" Dehumidifier Rod #222010

Box Size: 3.4"W x 20"H x 1"D Case Pack: 4

- Stabilizes air-temperature
- Easy-install plug attachment for 110/120v AC
- Perfect for gun safes, storage cabinets, closets and boat compartments
- Mounting brackets included



12"/8 Watt dries up to 100 cu. ft.
18"/12 Watt dries up to 200 cu. ft.

GOLDEN ROD® DEHUMIDIFIER RODS

12" Dehumidifier Rod #725721

Clam Size: 5.25"W x 18"H x 1.25"D Case Pack: 4

18" Dehumidifier Rod #725731

Clam Size: 5.25"W x 18"H x 1.25"D Case Pack: 4

24" Dehumidifier Rod #725741

36" Dehumidifier Rod #725751

Clam Size: 4.5"W x 39"H x 1"D Case Pack: 4

- Easy-install quick plug attachment
- Mounting brackets included
- 110/120v AC
- Lifetime Warranty



12"/12 watt dries up to 100 cu. ft.
18"/18 watt dries up to 200 cu. ft.
24"/25 watt dries up to 300 cu. ft.
36"/39 watt dries up to 500 cu. ft.



GUN SAVER™ DEHUMIDIFIER RODS

12" Dehumidifier Rod #725761

Clam Size: 5.25"W x 18"H x 1.25"D Case Pack: 4

18" Dehumidifier Rod #725771

Clam Size: 5.25"W x 24"H x 1.25"D Case Pack: 4



- Easy-install quick plug attachment
- Mounting brackets included
- Protects firearm investment
- 110/120v AC

12"/12 Watt dries up to 100 cu. ft.
18"/18 Watt dries up to 200 cu. ft.



6-HANDGUN MUZZLE RACK #1081878

Clam Size: 9.46"W x 11.6"H x 0.6"D Case Pack: 6

- 6-handgun capacity with upright access
- Fits .22- .50 caliber handguns
- Large, overmolded wire construction helps protect against firearm damage
- Stable design allows for secure use on vault shelves and shooting benches



HANDGUN RACKS

Single Handgun Rack (3-pack) #222314

Hanger Size: 3.3"W x 9.8"H x 3"D Case Pack: 6

4-Gun Handgun Rack #222200

Hanger Size: 5.8"W x 8.7"H x 4.9"D Case Pack: 6

6-Gun Handgun Rack #222210

Hanger Size: 5.8"W x 13.2"H x 4.9"D Case Pack: 6

- Holds most pistols and/or revolvers
- Non-marring finish
- Perfect for holding handguns while not in use at the range or stored in a safe



VAULT DRAWER #222155

Clam Size: 17"W x 16"H x 3.75"D Case Pack: 3

- Retaining bar keeps drawer secure
- Provides 11.5"W x 12"H x 2"D extra storage



AR MAGAZINE RACK #222972

Box Size: 4.25"W x 16"H x 5.5"D Case Pack: 4

- Free-standing or mountable (mounting hardware included)
- Non-marring vinyl coating
- Compatible with all in-line mags from 10-rounds up to 30-rounds
- Holds up to 10 AR-15 magazines



HANDGUN/AR UPPER HANGER #222817

Clam Size: 9"W x 19.25"H x 2"D Case Pack: 5

- Holds up to (2) spare AR upper receivers, T/C® Encore® barrels or shotgun barrels
- Holds up to 6 handguns of any size
- (3) mesh pistol hangers per side
- Pockets are heavy-duty mesh with elastic bands

INCLUDES

- Hook screws
- Wallboard hooks
- Door clips



Full dimensions: 8"W x 38.5"H x 0.75"D

HANGING ORGANIZERS

A. Large Hanging Organizer #222168

Clam Size: 8.5"W x 14.5"H x 2"D Case Pack: 5

B. Small Hanging Organizer #222170

Clam Size: 6.25"W x 6"H x .75"D Case Pack: 5

C. Handgun Hanger #222172

Clam Size: 7.25"W x 7"H x 1.25"D Case Pack: 5

- All built with durable mesh pockets
- Elastic bands (and zippers on Large Organizer) keep items secure
- Reinforced back panels
- Handgun Hanger fits most compact, medium and large frame handguns
- All Hanging Organizers mount using the Universal Attachment System



UNIVERSAL ATTACHMENT SYSTEM

The Universal Attachment System comes with vampire clip style inserts for use with carpeted interior vaults as well as high-strength magnet inserts for bare metal interiors.

A.



19.75"W x 12"H x .75"D

C.



8.25"W x 5"H x .75"D

B.



6.25"W x 6"H x .75"D

MAGNETIC BARREL REST #222177

Clam Size: 11.5"W x 7"H x 3.75"D Case Pack: 4

- Holds (3) guns when leaned against vault or steel surface
- Overmolded rubber contact points to protect firearm finish
- Vinyl-coated magnets



10.25"W x 5"H x 3"D

EXTERNAL 10" HANGER #222454

Clam Size: 10.75"W x 9.75"H x 1.5"D Case Pack: 4

- Holds up to 30 lbs
- High-strength, vinyl-coated magnets to protect vault finish
- Powder-coated steel construction for maximum durability



M&P[®]

by Smith & Wesson[®]



2021

NEW PRODUCTS

ABOUT US



Ready for whatever situation you find yourself in M&P has you covered. Dependable and durable our line of cutlery and lighting products are ready to go alongside your favorite M&P® firearm.



SKU | 1136217 UPC | 661120106814 CASE PACK | 3
 SKU | 1147101 UPC | 661120106821 CASE PACK | 12

SHIELD SPRING ASSIST

8Cr13MoV Stainless Steel
 Rubberized Handle for Enhanced Grip
 2.8" Blade Length
 6.8" Overall Length
 Liner Lock
 Finger Flipper
 Spring Assist
 Tip-Down Pocket Clip



PACKAGE | Blister
 PACKAGE | Box



SKU | 1136216 UPC | 661120106838 CASE PACK | 3
 SKU | 1147103 UPC | 661120106845 CASE PACK | 12

M&P® SPECIAL OPS® TANTO 4

9Cr18MoV Stainless Steel
 Titanium Nitride Blade Coating
 G10 Handle Scales
 4" Blade Length
 9.3" Overall Length
 Liner Lock
 Finger Flipper
 Spring Assist
 Tip-Up Pocket Clip



PACKAGE | Blister
 PACKAGE | Box



SKU | 1136215 UPC | 661120106791 CASE PACK | 3
 SKU | 1147102 UPC | 661120106807 CASE PACK | 12

M&P® EXTREME OPS® KARAMBIT

8Cr13MoV Stainless Steel
 Titanium Nitride Blade Coating
 G10 Handle Scales
 3" Blade Length
 7.8" Overall Length
 Liner Lock
 Spring Assist
 Finger Flipper/Hook Assist Open
 Finger Loop
 Reversible Tip-Up Pocket Clip



PACKAGE | Blister
 PACKAGE | Box

M&P

RETURNING PRODUCTS



REPO™ ASSISTED OPENING

- » 8Cr13MoV S.S. Steel Blade
- » Aluminum Overmolded Handle
- » Dual Thumb Studs
- » Liner Lock
- » Tip-Down Pocket Clip
- » Bottle Opener Carabiner

This rugged knife packs a punch with a built-in carabiner and bottle opener. Perfect as your EDC or clipping to your bag, the easy access ensures you'll always be ready.



Blade Length
3.5"
Overall Length
8.1"
Weight
4.96 oz.
Case Pack
Clam - 3
Box - 12



8.1"

1117199 **BLISTER**
1122579 **BOX**

UPC - 661120080824
UPC - 661120080770



5"

SEAR™ ASSISTED OPENING

- » 8Cr13MoV S.S. Steel Blade
- » S.S. Handle w/ G10 Inserts
- » Finger Flipper
- » Liner Lock
- » Tip-Down Pocket Clip

As smooth and polished as a custom trigger, the M&P® Sear springs into action with just a touch of the index flipper.



Blade Length
2.9"
Overall Length
6.9"
Weight
4.16 oz.
Case Pack
Clam - 3
Box - 12



6.9"

1117203 **BLISTER**
1122580 **BOX**

UPC - 661120080794
UPC - 661120080763



4"

OFFICER™ FOLDING KNIFE

- 8Cr13MoV S.S. Steel Blade
- G10 Handle Scales
- Finger Flipper
- Dual Thumb Studs
- Liner Lock
- Ultra-Glide™
- Reversible Pocket Clip
- Removable Tungsten Glass Breaker

The Officer Folding Knife was custom designed by our team of Law Enforcement and Security Officers. Textured G10 scales, an extra-large finger stop, and our Ultra-Glide bearing system make this knife perfect for personal or professional use.

Blade Length

3.1"

Overall Length

7.3"

Weight

3.84 oz.

Case Pack

Clam - 3

Box - 12

1117204

BLISTER

UPC - 661120080918

1122581

BOX

UPC - 661120080893



7.3"



4.4"

OFFICER™ FIXED BLADE KNIFE

- 8Cr13MoV S.S. Steel Blade
- G10 Handle Scales
- Full Tang
- Stainless Steel Pommel
- Removable Tungsten Glass Breaker
- Synthetic 360° Rotating Sheath

Custom designed for law enforcement, our Officer Fixed Blade Knife is sure to be the perfect addition for your personal or professional use. With a 4" Spear point blade and full tang construction, you'll never want to be without it.

Blade Length

4.3"

Overall Length

9"

Weight

9.12 oz.

Case Pack

Clam - 3

Box - 12

1117205

BLISTER

UPC - 661120080909

1122582

BOX

UPC - 661120080886



9"



6"

Includes an interchangeable 360° rotating sheath buckle and a standard metal belt buckle

SPECIAL OPS® SURVIVAL KNIVES

- » 9Cr13MoV S.S. Steel Blade
- » Rubberized Polymer Handle
- » Full Tang
- » S.S. Textured Hammer Pommel
- » Sawback Edge
- » Rigid Synthetic Tactical Sheath

A modern twist on a classic design, these knives are ready for your toughest tasks. With heavily textured, rubberized handles and a high-quality stainless steel blade, they are ready for whatever comes your way.

Weight

5" - 11.12 oz.

7" - 12.64 oz.

Case Pack

Clam - 3

Box - 12



1117201	5" SPECIAL OPS	BLISTER	UPC - 661120080817
1122583	5" SPECIAL OPS	BOX	UPC - 661120080758
1117202	7" SPECIAL OPS	BLISTER	UPC - 661120080800
1122584	7" SPECIAL OPS	BOX	UPC - 661120080749

M&P-15 MULTI-TOOL FIXED BLADE

- High Carbon S.S. Construction
- Integral Tools in Handle
- Full Tang
- M-LOK®/Keymod Compatible
- Rigid Synthetic Sheath
- TOOLS INCLUDED
 - Castle Nut Wrench
 - Bit Driver with 1 Double Sided Bit
 - Bottle Opener
 - 5/8" Buffer Tube Wrench
 - Flathead Screwdriver

Never choose between carrying a knife or an AR tool again. This M-LOK® / Keymod mountable multi-tool doubles as both your sharpest knife and your go-to AR tool, complete with all the tools you need to fix your MSR in the field.

Blade Length
3.3"
Overall Length
8"
Weight
3.84 oz.
Case Pack
Clam - 3
Box - 12

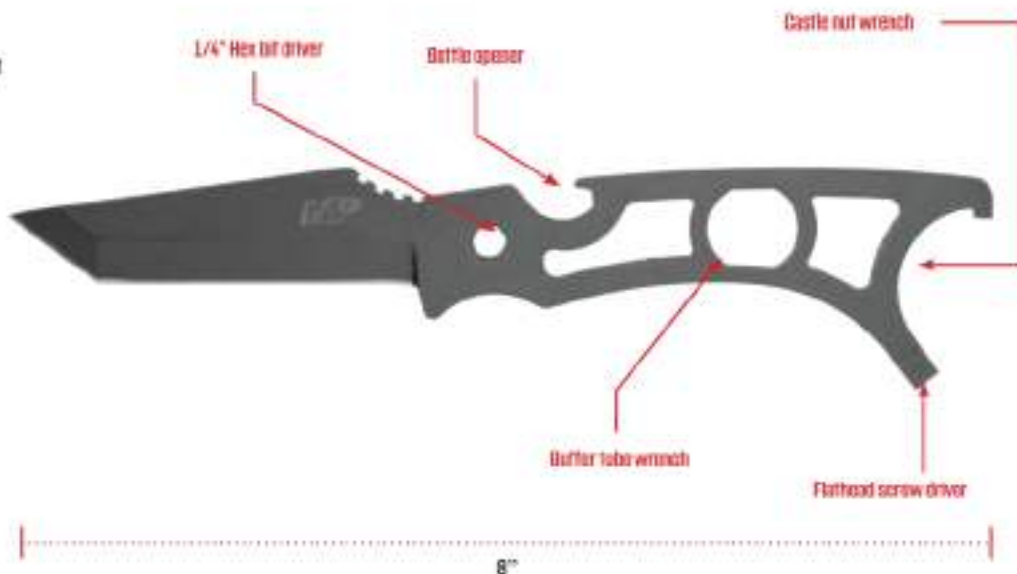

Mountable M&P-15 sheath comes with M-LOK® and Keymod adapters as well as a pocket clip adapter (shown right).



1117206 **BLISTER** UPC - 661120080848
1122585 **BOX** UPC - 661120080831



EXTREME OPS™ KARAMBIT KNIFE

- » 9Cr18MoV S.S. Steel Blade
- » G10 Handle Scales
- » Full Tang
- » Finger Loop
- » Rigid Dual Mount Synthetic Sheath

The perfect blend of speed and strength, the Extreme Ops' 9Cr stainless steel blade, and custom-designed G10 handle give you a grip solid enough for any situation.

Blade Length
3.0"
Overall Length
9.6"
Weight
7.2 oz.
Case Pack
Clam - 3
Box - 12



9.6"

1117207 BLISTER
1122586 BOX

UPC - 661120080879
UPC - 661120080882



6"



EXTRACTION AND EVASION[®] AXE

- High Carbon S.S. Steel
- Rubberized Handle
- Full Tang
- Spear Point Back Spike
- Synthetic Sheath

Super strong. Super tough. This tactical axe is built to handle anything and anyone.

Overall Length

15.5"

Weight

25.92 oz

Case Pack

3



15.5"

1117197 BLISTER

UPC - 661120080855



9.5"

EXTRACTION AND EVASION[®] CLEAVER

- 420 Stainless Steel Blade
- Overmolded Rubber Handle
- Full Tang
- Textured Hammer Pommel
- Sawback
- Synthetic Sheath with Shoulder Sling

Reach the ultimate leverage with this super rugged and perfectly balanced machete. This tool is big enough for any task and includes a sawback to increase your cut velocity.

Blade Length

10"

Overall Length

16.5"

Weight

17.6 oz

Case Pack

3



16.5"

1117208 BLISTER

UPC - 661120080787



17"

M&P M2.0 UG OD GREEN OVERMOLD

8Cr13MoV BLACK OXIDE COATED HIGH CARBON S.S. BLADE
RUBBERIZED OVERMOLD HANDLE

- » Ultra-Glide™ Technology
- » Finger Flipper
- » Liner Lock
- » Pocket Clip
- » Thumbstud

Blade Length
3.5" (8.89 cm)
 Overall Length
7.75" (19.685 cm)
 Weight
3.8 oz.



7.75"



4.5"

1100042 M&P M2.0 UG OD GREEN OVERMOLD BOX
 UPC - 661120076209

1100043 M&P M2.0 UG OD GREEN OVERMOLD CLAM
 UPC - 661120076216

M&P UG BLK ALUMINUM

8Cr13MoV BLACK OXIDE COATED HIGH CARBON S.S. BLADE
RUBBERIZED ALUMINUM HANDLE

- » Ultra-Glide™ Technology
- » Finger Flipper
- » Liner Lock
- » Pocket Clip

Blade Length
3" (7.62 cm)
 Overall Length
7" (17.78 cm)
 Weight
3 oz.



7"



4.25"

1100074 M&P UG BLK ALUMINUM BOX
 UPC - 661120076223

1100075 M&P UG BLK ALUMINUM CLAM
 UPC - 661120076230

M&P M2.0 2-TONE CLIP FOLDER TANTO

8Cr13MoV BLACK OXIDE COATED HIGH CARBON S.S. BLADE
RUBBERIZED OVERMOLDED HANDLE

- » Finger Flipper
- » Liner Lock
- » Pocket Clip
- » Thumbstud
- » Lanyard Hole

Blade Length
3.5" (8.89 cm)
 Overall Length
8.2" (20.828 cm)
 Weight
3.6 oz.



8.2"



4.75"

1100080 M&P M2.0 2-TONE CLIP FOLDER TANTO BOX
 UPC - 661120076308

1100081 M&P M2.0 2-TONE CLIP FOLDER TANTO CLAM
 UPC - 661120076315

M&P BODYGUARD CONNECT

8Cr13MoV HIGH CARBON S.S. BEAD BLAST BLADE
POLYMER HANDLE

- » Quick Disconnect Lanyard Loop Included
- » Liner Lock
- » Thumbstud

Blade Length
2.25" (5.715 cm)
 Overall Length
5.65" (14.351 cm)
 Weight
1.7 oz.



5.65"



3.75"

1100084 M&P BODYGUARD CONNECT BOX
 UPC - 661120076346

1100085 M&P BODYGUARD CONNECT CLAM
 UPC - 661120076353

M&P AR OVERMOLD

**8Cr13MoV BLACK OXIDE COATED HIGH CARBON S.S. BLADE,
2-TONE OVERMOLDED RUBBER HANDLE**

- » Liner Lock
- » Pocket Clip
- » Thumbstud

Blade Length
3.5" (8.89 cm)
Overall Length
8.2" (20.828 cm)
Weight
3.9 oz.



8.2"



4.65"

1100082 M&P AR OVERMOLD BOX
UPC - 661120076322

1100083 M&P AR OVERMOLD CLAM
UPC - 661120076339

M&P M2.0 UG TI RUB ALUMINUM

**8Cr13MoV TI-NITRIDE BLADE
RUBBERIZED ALUMINUM HANDLE**

- » Ultra-Glide™ Technology
- » Finger Flipper
- » Liner Lock
- » Pocket Clip
- » Thumbstud

Blade Length
2.75" (6.985 cm)
Overall Length
6.5" (16.51 cm)
Weight
3 oz.



6.5"



3.75"

1100040 M&P M2.0 UG TI RUB ALUMINUM BOX
UPC - 661120076186

1100041 M&P M2.0 UG TI RUB ALUMINUM CLAM
UPC - 661120076193

M&P S&W BODYGUARD

**8Cr13MoV TI-NITRIDE BLADE
RUBBERIZED ALUMINUM HANDLE**

- » Ultra-Glide™ Technology
- » Finger Flipper
- » Liner Lock
- » Pocket Clip
- » Thumbstud

Blade Length
2.75" (6.985 cm)
Overall Length
6.25" (15.875 cm)
Weight
2.2 oz.



6.25"



3.65"

1100068 M&P S&W BODYGUARD TI GREY BOX
UPC - 661120076285

1100069 M&P S&W BODYGUARD TI GREY CLAM
UPC - 661120076292

M&P 2.0 ASSISTED OPENING

**8Cr13MoV BLACK OXIDE COATED HIGH CARBON S.S. BLADE
RUBBERIZED ALUMINUM HANDLE**

- » Light FDE
- » Tungsten Window Punch
- » Strap Cutter
- » Liner Lock
- » Pocket Clip

Blade Length
3.5" (8.89 cm)
Overall Length
8" (20.32 cm)
Weight
4.3 oz.



8"



4.75"

1100076 M&P 2.0 ASSISTED OPENING BOX
UPC - 661120076247

1100077 M&P 2.0 ASSISTED OPENING CLAM
UPC - 661120076254

M&P ASSISTED OPENING DUAL
**8Cr13MoV BLACK OXIDE COATED HIGH CARBON S.S. BLADE
RUBBERIZED POLYMER HANDLE**

- » Tungsten Window Punch
- » Hex Wrench
- » Strap Cutter
- » Bottle Opener
- » Ferro Rod
- » Whistle
- » Screwdriver
- » Liner Lock
- » Pocket Clip

Blade Length
3.5" (8.89 cm)
Overall Length
8.5" (21.59 cm)
Weight
5.6 oz.

**ASSISTED
OPENING**

8.5"



5"

1100078 M&P ASSISTED OPENING DUAL BOX

UPC - 661120076261

1100079 M&P ASSISTED OPENING DUAL CLAM

UPC - 661120076278

M&P GLASSBREAKER TACTICAL PEN
6061 AIRCRAFT ALUMINUM, SCHMIDT P635M D1

- » Parker Style Black Ballpoint Pen Refill
- » Patent Pending
- » Spring-Loaded Window Punch
- » Twist Cap
- » Pocket Clip

Overall Length
6" (15.24 cm)
Weight
1.9 oz.



Pocket Clip



Pocket Clip

6"

1100098 BLACK GB TACTICAL BOX

UPC - 661120076360

1100099 BLACK GB TACTICAL CLAM

UPC - 661120076377

1100100 OD GREEN GB TACTICAL BOX

UPC - 661120076384

1100101 OD GREEN GB TACTICAL CLAM

UPC - 661120076391

1084314
OTF ASSISTED OPENING

**AUS-8 BLACK OXIDE COATED HIGH CARBON S.S. BLADE
ALUMINUM HANDLE**

- » Blade Release
- » Safety Lock
- » Large Finger Actuator
- » Glass Breaker
- » Blade Slider
- » Lanyard Hole

 Blade Length
3.5" (8.89 cm)

 Overall Length
8.66" (22 cm)

 Weight
6 oz.

 UPC
661120413691

8.66"



5.12"

1084315
OTF ASSISTED OPENING

**AUS-8 BLACK OXIDE COATED HIGH CARBON S.S. BLADE
ALUMINUM HANDLE**

- » Blade Release
- » Safety Lock
- » Large Finger Actuator
- » Glass Breaker
- » Blade Slider
- » Lanyard Hole

 Blade Length
3.5" (8.89 cm)

 Overall Length
8.66" (22 cm)

 Weight
6 oz.

 UPC
661120413707

8.66"



5.12"

M&P® M2.0™
ASSISTED OPENING
**4034 BLACK OXIDE COATED HIGH CARBON S.S. BLADE
ALUMINUM W/RUBBER INSERTS HANDLE**

- Finger Actuator
- Secondary Lock Auto Locks When Opened
- Thin Profile
- Pocket Clip
- Lanyard Hole

Blade Length
3.5" (8.89 cm)
Overall Length
8.5" (21.59 cm)
Weight
5.8 oz.



8.5"



4.92"

1084316 CLIP POINT BLADE BLACK/ALUMINUM HANDLE BOX
UPC - 661120413714

1084317 CLIP POINT BLADE BLACK/ALUMINUM HANDLE CLAM
UPC - 661120413721

M&P® SHIELD™
ASSISTED OPENING
**8Cr13MoV BLACK OXIDE COATED HIGH CARBON S.S. BLADE
ALUMINUM W/RUBBER OVERMOLDED HANDLE**

- Ball Bearing Pocket Clip
- Dual Thumbstuds
- Liner Lock
- Lanyard Hole

Blade Length
2.75" (6.99 cm)
Overall Length
6.7" (17 cm)
Weight
3.6 oz.



6.7"



3.74"

1085918 DROP POINT BLADE BLACK/GREY HANDLE BOX
UPC - 661120414223

1085919 DROP POINT BLADE BLACK/GREY HANDLE CLAM
UPC - 661120414230



ASSISTED OPENING

4034 BLACK OXIDE S.S. BLADE ALUMINUM HANDLE

- M.A.G.I.C. Assisted Opening
- Finger Actuator
- Dual Thumb Knobs
- Liner Lock
- Safety Lock
- Pocket Clip

SWMP9B

M&P® SMITH & WESSON®

Blade Length
3.5" (8.9 cm)
Overall Length
8.5" (21.6 cm)
Weight
7.9 oz.

ASSISTED
OPENING



8.5"

SWMP9B CLIP POINT BLADE GREY HANDLE BOX

UPC - 028634706662

SWMP9BT TANTO POINT BLADE GREY HANDLE BOX

UPC - 028634706686

SWMP9BTS TANTO POINT SERRATED BLADE GREY HANDLE BOX

UPC - 028634706693



Tanto Blade Option



Serrated Tanto Blade Option



5"

SWMP2BS

M&P® SMITH & WESSON®

ASSISTED
OPENING



Blade Length
2.8" (7.1 cm)
Overall Length
7" (17.8 cm)
Weight
4.1 oz.
UPC
028634701094



7"



4.2"



**4034 BLACK OXIDE S.S. BLADE
ALUMINUM HANDLE**

- » M.A.G.I.C. Assisted Opening
- » Finger Actuator
- » Dual Thumb Knobs
- » Liner Lock
- » Safety Lock
- » Pocket Clip

SWMP6

M&P® SMITH & WESSON®

Blade Length
3.4" (8.6 cm)
Overall Length
7.7" (19.6 cm)
Weight
5.5 oz.



7.7"



Serrated Blade Option



4.3"

SWMP6 CLIP POINT BLADE GREY HANDLE BOX

UPC - 028634704798

SWMP6CP CLIP POINT BLADE GREY HANDLE CLAM

UPC - 028634704859

SWMP6S CLIP POINT SERRATED BLADE GREY HANDLE BOX

UPC - 028634704804

SWMP6BS

M&P® SMITH & WESSON®

Blade Length
3.4" (8.6 cm)
Overall Length
7.7" (19.6 cm)
Weight
5.5 oz.
UPC
028634704828



7.7"



4.3"

SWMP6 Series
SWMP6CN
M&P® SMITH & WESSON®

Blade Length
3.4" (8.8 cm)
Overall Length
7.7" (19.8 cm)
Weight
5.5 oz.



7.7"

Serrated Blade Option

4.3"

- SWMP6CN** CLIP POINT BLADE GREY/BLACK HANDLE BOX
UPC - 028634705009
- SWMP6CNCP** CLIP POINT BLADE GREY/BLACK HANDLE CLAM
UPC - 028634705023
- SWMP6CNS** CLIP POINT SERRATED BLADE GREY/BLACK HANDLE BOX
UPC - 028634705016
- SWMP6CNSCP** CLIP POINT SERRATED BLADE GREY/BLACK HANDLE CLAM
UPC - 028634705030



ASSISTED OPENING

4034 BLACK OXIDE S.S. BLADE ALUMINUM HANDLE

- M.A.G.I.C. Assisted Opening
- Finger Actuator
- Thumb Plate
- Liner Lock
- Safety Lock
- Glass Breaker
- Pocket Clip

SWMP4LBS

M&P® SMITH & WESSON®

Blade Length
3.6" (9.1 cm)
Overall Length
8.6" (21.8 cm)
Weight
7.6 oz.
UPC
028634702589

ASSISTED
OPENING



8.6"



5"

SWMP4L

M&P® SMITH & WESSON®

Blade Length
3.8" (9.1 cm)
Overall Length
8.8" (21.8 cm)
Weight
7.6 oz.

ASSISTED
OPENING



8.8"



Serrated Blade Option



5"

SWMP4L CLIP POINT BLADE GREY HANDLE BOX

UPC - 028634702558

SWMP4LS CLIP POINT SERRATED BLADE GREY HANDLE BOX

UPC - 028634702565

SWMP4LSCP CLIP POINT SERRATED BLADE GREY HANDLE CLAM

UPC - 028634703678



ASSISTED OPENING

4034 S.S. BLADE ALUMINUM HANDLE

- M.A.G.I.C. Assisted Opening
- Finger Actuator
- Dual Thumb Knobs
- Liner Lock
- Safety Lock
- Glass Breaker
- Pocket Clip

SWMP1

M&P® SMITH & WESSON®

Blade Length
2.9" (7.4 cm)
Overall Length
7.1" (18.0 cm)
Weight
4.1 oz.
UPC
028634701001

ASSISTED
OPENING



7.1"



4.2"

SWMP1B

M&P® SMITH & WESSON®

Blade Length
2.9" (7.4 cm)
Overall Length
7.1" (18.0 cm)
Weight
4.1 oz.

ASSISTED
OPENING



7.1"



Serrated Blade Option



4.2"

SWMP1B CLIP POINT BLADE GREY/BLACK HANDLE BOX

UPC - 028634701063

SWMP1BCP CLIP POINT BLADE GREY/BLACK HANDLE CLAM

UPC - 028634703708

SWMP1BS CLIP POINT SERRATED BLADE GREY/BLACK HANDLE BOX

UPC - 028634701070

SWMP1BSCP CLIP POINT SERRATED BLADE GREY/BLACK HANDLE CLAM

UPC - 028634703142



ASSISTED OPENING

SWMP5L

M&P® SMITH & WESSON®



4034 BLACK OXIDE S.S. BLADE ALUMINUM HANDLE

- M.A.G.I.C. Assisted Opening
- Finger Actuator
- Thumb Plate
- Liner Lock
- Safety Lock
- Glass Breaker
- Pocket Clip

Blade Length
3.5" (8.9 cm)
Overall Length
8.5" (21.6 cm)
Weight
7.2 oz.



Serrated Blade Option



SWMP5L CLIP POINT BLADE GREY/BLACK HANDLE BOX

UPC - 028634702732

SWMP5LCP CLIP POINT BLADE GREY/BLACK HANDLE CLAM

UPC - 028634703885

SWMP5LS CLIP POINT SERRATED BLADE GREY/BLACK HANDLE BOX

UPC - 028634702749

SWMP1BSD

M&P® SMITH & WESSON®



4034 BLACK OXIDE S.S. BLADE ALUMINUM HANDLE

- M.A.G.I.C. Assisted Opening
- Finger Actuator
- Dual Thumb Knobs
- Liner Lock
- Safety Lock
- Glass Breaker
- Pocket Clip

Blade Length
2.9" (7.4 cm)
Overall Length
7.1" (18.0 cm)
Weight
4.1 oz.
UPC
028634701463



4.2"



ASSISTED OPENING

4034 BLACK OXIDE S.S. BLADE ALUMINUM HANDLE

- M.A.G.I.C. Assisted Opening
- Finger Actuator
- Dual Thumb Knobs
- Liner Lock
- Safety Lock
- Glass Breaker
- Pocket Clip

SWMP3BS0

M&P® SMITH & WESSON®

Blade Length
2.8" (7.1 cm)
Overall Length
7.1" (18.0 cm)
Weight
4.1 oz.

ASSISTED
OPENING



SWMP3BS0 TANTO POINT SERRATED BLADE FDE/BLACK HANDLE BOX

UPC - 028634701520

SWMP3BSDCP TANTO POINT SERRATED BLADE FDE/BLACK HANDLE CLAM

UPC - 028634703609



SWMP3B

M&P® SMITH & WESSON®

Blade Length
2.8" (7.1 cm)
Overall Length
7.1" (18.0 cm)
Weight
4.1 oz.

ASSISTED
OPENING



SWMP3B TANTO POINT BLADE GREY/BLACK HANDLE BOX

UPC - 028634701100

SWMP3BS TANTO POINT SERRATED BLADE GREY/BLACK HANDLE BOX

UPC - 028634701117

SWMP3BSCP TANTO POINT SERRATED BLADE GREY/BLACK HANDLE CLAM

UPC - 028634703497



Serrated Blade Option





FOLDING KNIVES

M&P® M2.0™ ULTRA GLIDE® FOLDING KNIFE



8Cr13MoV BLACK OXIDE COATED HIGH CARBON S.S. BLADE
ALUMINUM & NYLON HANDLE

- Dual Thumbstuds
- Finger Actuator
- Liner Lock
- Pocket Clip
- Lanyard Hole

Blade Length
3.5" (8.89 cm)
Overall Length
8.07" (20 cm)
Weight
5.1 oz.



8.07"



1085908 DROP POINT BLADE BLACK/FDE HANDLE BOX
UPC - 661120414070

1085909 DROP POINT BLADE BLACK/FDE HANDLE CLAM
UPC - 661120414087

1085910 DROP POINT BLADE BLACK/GREY HANDLE BOX
UPC - 661120414094

1085911 DROP POINT BLADE BLACK/GREY HANDLE CLAM
UPC - 661120414155



4.53"

M&P® M2.0™ ULTRA GLIDE® FOLDING KNIFE



8Cr13MoV BLACK OXIDE COATED HIGH CARBON S.S. BLADE
ALUMINUM & NYLON HANDLE

- Finger Actuator
- Liner Lock
- Dual Thumbstuds
- Pocket Clip
- Lanyard Hole

Blade Length
2.75" (6.99 cm)
Overall Length
6.1" (15.5 cm)
Weight
3 oz.



6.1"



3.54"

1085904 DROP POINT BLADE BLACK/FDE HANDLE BOX
UPC - 661120414032

1085905 DROP POINT BLADE BLACK/FDE HANDLE CLAM
UPC - 661120414049

M&P® M2.0™ ULTRA GLIDE® FOLDING KNIFE

**8Cr13MoV BLACK OXIDE COATED HIGH CARBON S.S. BLADE
ALUMINUM TEXTURED HANDLE**

- Dual Thumbstuds
- Finger Actuator
- Liner Lock
- Pocket Clip
- Lanyard Hole

Blade Length
2.75" (6.99 cm)
Overall Length
6.89" (17.5 cm)
Weight
3.2 oz.



6.89"



3.94"



1085902 DROP POINT BLADE FDE/BLACK HANDLE BOX
UPC - 661120414018

1085903 DROP POINT BLADE FDE/BLACK HANDLE CLAM
UPC - 661120414025

M&P® M2.0™ ULTRA GLIDE® FOLDING KNIFE

**8Cr13MoV BLACK OXIDE COATED HIGH CARBON S.S. BLADE
NYLON TEXTURED RUBBER OVERMOLDED HANDLE**

- Finger Actuator
- Liner Lock
- Dual Thumbstuds
- Pocket Clip

Blade Length
3.5" (8.89 cm)
Overall Length
8.07" (20 cm)
Weight
4.8 oz.



8.07"



4.53"



1085912 DROP POINT BLADE BLACK HANDLE BOX
UPC - 661120414162

1085913 DROP POINT BLADE BLACK HANDLE CLAM
UPC - 661120414179

M&P® BODYGUARD™
FOLDING KNIFE

**8Cr13MoV BLACK OXIDE COATED HIGH CARBON S.S. BLADE
GLASS FILLED TEXTURED NYLON HANDLE**

- Finger Actuator
- Liner Lock
- Dual Thumbblades
- Pocket Clip
- Lanyard Hole

Blade Length
2.75" (6.99 cm)
Overall Length
6.5" (16.5 cm)
Weight
2.6 oz.



6.5"



3.74"

1085890 CLIP POINT BLADE BLACK HANDLE BOX
UPC - 661120413899

1085891 CLIP POINT BLADE BLACK HANDLE CLAM
UPC - 661120413905

M&P® SHIELD™
FOLDING DAGGER

**8Cr13MoV BLACK OXIDE COATED HIGH CARBON S.S. BLADE
ALUMINUM & NYLON HANDLE**

- Dual Finger Actuators
- Liner Lock
- Pocket Clip
- Lanyard Hole

Blade Length
2.75" (6.99 cm)
Overall Length
6.1" (15.5 cm)
Weight
2.2 oz.



6.1"



3.74"

1085892 5 TILETTO POINT BLADE BLACK/GREY HANDLE BOX
UPC - 661120413912

1085893 5 TILETTO POINT BLADE BLACK/GREY HANDLE CLAM
UPC - 661120413929

1085894 5 TILETTO POINT BLADE BLACK/FDE HANDLE BOX
UPC - 661120413936

1085895 5 TILETTO POINT BLADE BLACK/FDE HANDLE CLAM
UPC - 661120413943

FOLDING DAGGER

**8Cr13MoV BLACK OXIDE COATED HIGH CARBON S.S. BLADE
ALUMINUM & NYLON HANDLE**

- » Liner Lock
- » Thumbstud
- » Pocket Clip

Blade Length
4" (10.16 cm)
Overall Length
8.66" (22 cm)
Weight
5 oz.



8.66"



4.72"

1085898 CLIP POINT BLADE BLACK/GREY HANDLE BOX
UPC - 661120413974

1085899 CLIP POINT BLADE BLACK/GREY HANDLE CLAM
UPC - 661120413981

M&P® BODYGUARD™ FOLDING KNIFE

**8Cr13MoV BLACK OXIDE COATED HIGH CARBON S.S. BLADE
ALUMINUM & NYLON HANDLE**

- » Finger Actuator
- » Liner Lock
- » Dual Thumbstuds
- » Pocket Clip

Blade Length
3.5" (8.89 cm)
Overall Length
8.07" (20 cm)
Weight
4.2 oz.



8.07"



4.33"

1085900 TANTO POINT SERRATED BLADE GREY/WOOD HANDLE BOX
UPC - 661120413998

1085901 TANTO POINT SERRATED BLADE GREY/WOOD HANDLE CLAM
UPC - 661120414001



7Cr17MoV HIGH CARBON S.S. BLADE
ALUMINUM HANDLE

- Dual Thumb Knobs
- Liner Lock
- Index Flipper
- Strap Cutter
- Ceramic Glass Breaker
- Pocket Clip

SWNP10

M&P® SMITH & WESSON®

Blade Length
3.9" (9.8 cm)
Overall Length
8.9" (22.6 cm)
Weight
5.2 oz.
UPC
028634708451



8.9"



5.11"





**7Cr17MoV HIGH CARBON S.S. BLADE
ALUMINUM HANDLE**

- ▶ Dual Thumb Knobs
- ▶ Ceramic Glass Breaker
- ▶ Liner Lock
- ▶ Pocket Clip
- ▶ Strap Cutter

SWMP11B

M&P® SMITH & WESSON®

Blade Length
3.8" (9.6 cm)
Overall Length
8.9" (22.7 cm)
Weight
5.7 oz.



8.9"



5.19"

SWMP11B TANTO POINT BLADE BLACK HANDLE BOX
UPC - 028634708604

SWMP11BCP TANTO POINT BLADE BLACK HANDLE CLAM
UPC - 028634708611

SWMP11G

M&P® SMITH & WESSON®

Blade Length
3.8" (9.6 cm)
Overall Length
8.9" (22.7 cm)
Weight
5.7 oz.



8.9"



5.19"

SWMP11G TANTO POINT BLADE GREY HANDLE BOX
UPC - 028634708895

SWMP11GCP TANTO POINT BLADE GREY HANDLE CLAM
UPC - 028634708901

SWMP7TSCP
M&P® SMITH & WESSON®
**9Cr18MoV HIGH CARBON BLACK OXIDE S.S. BLADE
RUBBER INJECTED ALUMINUM HANDLE**

- Dual Thumb Knobs
- Push Button Lock
- Pocket Clip

Blade Length
3.1" (8.1 cm)
Overall Length
7.7" (19.8 cm)
Weight
3.2 oz.
UPC
028634706129

SWMP8BS
M&P® SMITH & WESSON®
**9Cr18MoV HIGH CARBON BLACK OXIDE S.S. BLADE
RUBBER INJECTED ALUMINUM HANDLE**

- Dual Thumb Knobs
- Push Button Lock
- Strap Cutter
- Glass Breaker
- Pocket Clip

Blade Length
3.2" (8.1 cm)
Overall Length
7.8" (19.8 cm)
Weight
3.5 oz.
UPC
028634708150



**BCr13MoV HIGH CARBON BLACK OXIDE S.S. BLADE
ALUMINUM HANDLE**

- Dual Thumb Knobs
- Index Flipper
- Liner Lock
- Pocket Clip

SWMP13BS
M&P® SMITH & WESSON®

Blade Length
3.5" (8.8 cm)
Overall Length
8.2" (20.9 cm)
Weight
4.9 oz.



SWMP13BS CLIP POINT SERRATED BLADE BLACK/FDE HANDLE BOX
UPC - 029834709250

SWMP13BSCP CLIP POINT SERRATED BLADE BLACK/FDE HANDLE CLAM
UPC - 029834709267

SWMP13GS
M&P® SMITH & WESSON®

Blade Length
3.5" (8.8 cm)
Overall Length
8.2" (20.9 cm)
Weight
4.9 oz.



SWMP13GS CLIP POINT SERRATED BLADE BLACK/SILVER HANDLE BOX
UPC - 029834709238

SWMP13GSCP CLIP POINT SERRATED BLADE BLACK/SILVER HANDLE CLAM
UPC - 029834709243

SWMP13GLS
M&P® SMITH & WESSON®

Blade Length
3.5" (8.8 cm)
Overall Length
8.2" (20.9 cm)
Weight
4.9 oz.



SWMP13GLS CLIP POINT SERRATED BLADE FDE/BLACK HANDLE BOX
UPC - 029834709274

SWMP13GLSCP CLIP POINT SERRATED BLADE FDE/BLACK HANDLE CLAM
UPC - 029834709281





FIXED BLADES

8Cr13MoV HIGH CARBON BLACK OXIDE S.S. BLADE ALUMINUM W/RUBBER HANDLE

- Full Tang
- M.O.L.L.E. Compatible Thermoplastic Belt Sheath

SWMPF2BS

M&P® SMITH & WESSON®

Blade Length
4.1" (10.3 cm)
Overall Length
8.7" (22.1 cm)
Weight
8.6 oz.



8.7"



8WMPF2BS CLIP POINT SERRATED BLADE SILVER/BLACK HANDLE BOX
UPC - 028634709502

8WMPF2BSCP CLIP POINT SERRATED BLADE SILVER/BLACK HANDLE CLAM
UPC - 028634709519

SWMPF2CS

M&P® SMITH & WESSON®

Blade Length
4.1" (10.3 cm)
Overall Length
8.7" (22.1 cm)
Weight
8.6 oz.



8.7"



8WMPF2CS CLIP POINT SERRATED BLADE FDE/BLACK HANDLE BOX
UPC - 028634992355

8WMPF2CSCP CLIP POINT SERRATED BLADE FDE/BLACK HANDLE CLAM
UPC - 028634992348

**8Cr13MoV HIGH CARBON BLACK OXIDE S.S. BLADE
RUBBERIZED HANDLE**

- Full Tang
- Thermoplastic Belt/Boot Sheath

SWMPF3BR**M&P® SMITH & WESSON®**

Blade Length
4.6" (11.6 cm)
Overall Length
9" (22.9 cm)
Weight
3.5 oz.



SWMPF3BR DAGGER POINT BLADE FDE/BLACK HANDLE BOX
UPC - 028834709540

SWMPF3BRCP DAGGER POINT BLADE FDE/BLACK HANDLE CLAM
UPC - 028834709526

**SWMPF3G****M&P® SMITH & WESSON®**

Blade Length
4.6" (11.6 cm)
Overall Length
9.0" (22.9 cm)
Weight
3.5 oz.



SWMPF3G DAGGER POINT BLADE GREY/BLACK HANDLE BOX
UPC - 028834709557

SWMPF3GCP DAGGER POINT BLADE GREY/BLACK HANDLE CLAM
UPC - 028834709533



M&P® SHIELD™ FIXED BLADE

**8Cr13MoV BLACK OXIDE COATED HIGH CARBON S.S. BLADE
GLASS FILLED NYLON HANDLE**

- Full Tang
- Thumb Jimping
- Thin Profile
- Pocket Clip
- Lanyard Hole
- Nylon Fiber Sheath

Blade Length
3" (7.62 cm)
Overall Length
7.5" (19.05 cm)
Weight
4 oz.



7.5"



1084320 CLIP POINT BLADE BLACK HANDLE BOX
UPC - 661120413752

1084321 CLIP POINT BLADE BLACK HANDLE CLAM
UPC - 661120413769

M&P® SHIELD™ FIXED BLADE

**8Cr13MoV TI-NITRIDE COATED HIGH CARBON S.S. BLADE
GLASS FILLED NYLON HANDLE**

- Full Tang
- Thumb Jimping
- Thin Profile
- Lanyard Hole
- Belt Loop
- Nylon Fiber Sheath

Blade Length
3.25" (8.25 cm)
Overall Length
7.5" (19.05 cm)
Weight
3.2 oz.



7.5"



1084322 CLIP POINT BLADE BLACK HANDLE BOX
UPC - 661120413776

1085879 CLIP POINT BLADE BLACK HANDLE CLAM
UPC - 661120413783

M&P® M2.0™
THIN FIXED BLADE

8Cr13MoV BLACK OXIDE COATED HIGH CARBON S.S. BLADE
RUBBER OVERMOLDED HANDLE

- Full Tang
- Thumb Jimping
- Thin Profile
- Lanyard Hole
- Nylon Fiber Sheath

Blade Length
 4" (10.16 cm)

Overall Length
 9" (22.86 cm)

Weight
 5.1 oz.



1085880 DROP POINT BLADE BLACK HANDLE BOX
 UPC - 661120413700

1085881 DROP POINT BLADE BLACK HANDLE CLAM
 UPC - 661120413806

1085882 DROP POINT BLADE FDE HANDLE BOX
 UPC - 661120413813

1085883 DROP POINT BLADE FDE HANDLE CLAM
 UPC - 661120413820

SCREW CAP

M&P® SMITH & WESSON®

T6061 AIRCRAFT ALUMINUM

- Screw Cap Pen
- Schmidt P900M Parker Style Black Ball Point Pen Refill

Overall Length
5.8" (14.7 cm)
Weight
1.4 oz.



Black



Blue



Bronze



Grey

SWPENMP2BK SCREW CAP BLACK PEN BOX
UPC - 028634704897

SWPENMP2BL SCREW CAP BLUE PEN BOX
UPC - 028634704927

SWPENMP2BR SCREW CAP BRONZE PEN BOX
UPC - 028634704903

SWPENMP2G SCREW CAP GREY PEN BOX
UPC - 028634704910

PULL CAP

M&P® SMITH & WESSON®

T6061 AIRCRAFT ALUMINUM

- Pull Cap Pen
- Schmidt P900M Parker Style Black Ball Point Pen Refill

Overall Length
6.1" (15.5 cm)
Weight
1.4 oz.



Black



Grey



Olive



Silver



SWPENMPBK PULL CAP BLACK PEN BOX
UPC - 028634702961

SWPENMPG PULL CAP GREY PEN BOX
UPC - 028634702978

SWPENMPOD PULL CAP OLIVE PEN BOX
UPC - 028634702985

SWPENMPS PULL CAP SILVER PEN BOX
UPC - 028634702992



Smith & Wesson®
2021 NEW PRODUCTS

ABOUT US



From personal safety to backyard fun Smith & Wesson® has you covered. From cutlery to lighting we have everything you need for everyday carry to pair perfectly with your favorite firearm.



24/7® TANTO FOLDER

8Cr13MoV Stainless Steel
 G10 Handle Scales
 3.5" Blade Length
 8.25" Overall Length
 Liner Lock
 Ultra-Glide Bearing System
 Finger Flipper
 Tip-Up Pocket Clip



SKU | 1136219
 SKU | 1147097

UPC | 661120107064
 UPC | 661120107071

CASE PACK | 3
 CASE PACK | 12

PACKAGE | Blister
 PACKAGE | Box



24/7® TANTO FIXED

8Cr13MoV Stainless Steel
 G10 Handle Scales
 4" Blade Length
 8.5" Overall Length
 Full Tang
 Rigid Sheath Included

SKU | 1136218
 SKU | 1147099

UPC | 661120107132
 UPC | 661120107149

CASE PACK | 3
 CASE PACK | 12

PACKAGE | Blister
 PACKAGE | Box

EXECUTIVE BARLOW SPRING ASSIST

8Cr13MoV Stainless Steel
 G10 Handle Scales
 2.75" Blade Length
 6.25" Overall Length
 Liner Lock
 Spring Assisted Opening
 Finger Flipper
 Tip-Down Pocket Clip



SKU | 1136223
 SKU | 1147094

UPC | 661120107040
 UPC | 661120107057

CASE PACK | 3
 CASE PACK | 12

PACKAGE | Blister
 PACKAGE | Box



MULTI-TOOL FOLDING KNIFE

Stainless Steel
 2" Blade Length
 5.5" Overall Length
 Frame Lock
 Three Hex Wrenches & Flathead Screwdriver
 Hydration Tool
 Tip-Down Pocket Clip

SKU | 1136970 UPC | 661120104308 CASE PACK | 3 PACKAGE | Blister



WOOD HANDLE FOLDER

8Cr13MoV Stainless Steel
 3.7" Blade Length
 8.5" Overall Length
 Frame Lock
 Stainless Steel Handle with Wood Inserts
 Tip-Down Pocket Clip

SKU | 1136969 UPC | 661120104292 CASE PACK | 3 PACKAGE | Blister
 SKU | 1147091 UPC | 661120107033 CASE PACK | 12 PACKAGE | Box



BLACK OPS® RECURVE SPRING ASSIST

8Cr13MoV Stainless Steel
 G10 Handle Scales
 3.5" Blade Length
 8" Overall Length
 Liner Lock
 Spring Assisted Opening
 Finger Flipper
 Reversible Pocket Clip



SKU | 1136220 UPC | 661120107088 CASE PACK | 3 PACKAGE | Blister
 SKU | 1147098 UPC | 661120107095 CASE PACK | 12 PACKAGE | Box



BULLSEYE® THROWING CLEAVERS

Stainless Steel
10" Overall Length
3 Pack
Hydration Tool
Nylon Sheath



*Final product subject to change without notice

SKU | 1136221

UPC | 661120107118

CASE PACK | 3

PACKAGE | Blister



BULLSEYE® THROWING CARDS

Stainless Steel
Textured Back for Enhanced Grip
4 Pack
Card size: 2.5" x 3.5"
Laser Etched
Nylon Sheath



SKU | 1136222

UPC | 661120107101

CASE PACK | 3

PACKAGE | Blister



S&W BULLSEYE® ULTIMATE THROWING COMBO

Stainless Steel
3 Pack Cleavers, Axes, & Knives
4 Pack Cards
Sheaths Included



SKU | 1139486

UPC | 661120107125

CASE PACK | 3

PACKAGE | Box



A close-up photograph of a Smith & Wesson knife. The top portion shows a black handle with a fine, pebbled texture. On the handle, the Smith & Wesson logo (a circular emblem with a figure) is embossed in white, followed by the brand name "Smith & Wesson" in a white, serif font. Below the handle is a silver-colored metal blade with a smooth finish. The bottom portion of the image shows a yellow-green handle with a similar pebbled texture, featuring a faint, embossed version of the Smith & Wesson logo. The background is a dark, textured surface.

 Smith & Wesson®

RETURNING PRODUCTS

Performance Center®

by Smith & Wesson®

ALLEGIANCE™ FIXED BLADE
Numbered Limited Edition, Only 1,000 Made

- » 14C28N S.S. Steel Blade
- » Cocobolo Handle
- » S.S. Guard and Pommel
- » Full Tang
- » Brass Pins
- » Leather Sheath
- » Numbered Limited Edition

Introducing our newest fixed blade knife, the Allegiance. This limited-edition knife is made in the USA, crafted to the highest quality and backed by Smith & Wesson®. Don't miss your chance to own the one-of-a-kind Smith & Wesson® Performance Center® Allegiance.



Blade Length
4"
Overall Length
9.25"
Case Pack
2



9.25"



1117226 BOX UPC - 681120080002

HOMELAND™ FOLDING KNIFE
Numbered Limited Edition, Only 1,000 Made

- » 14C28N S.S. Steel Blade
- » Stainless Steel handle with G10 Scales
- » Finger Flipper
- » Liner Lock
- » Tip Down Pocket Clip
- » Numbered Limited Edition

Introducing the Homeland folding knife. Expect only the highest quality craftsmanship backed by Smith & Wesson®. Made in the U.S.A. and limited-edition so don't miss your chance to own the one-of-a-kind Smith & Wesson® Performance Center® Homeland.



Blade Length
3.5"
Overall Length
8"
Weight
4 oz.
Case Pack
2



8"



Designed after the Performance Center® SW1911.



3.94"

1117227 BOX UPC - 681120080085

Smith & Wesson®

DRIVE™ FOLDING KNIFE

- » Stainless Steel Blade
- » Stonewashed Aluminum Handle
- » Finger Flipper
- » Frame Lock
- » Ultra-Glide™
- » Bottle Opener

Blade Length

1.3"

Overall Length

3.3"

Weight

1.2 oz.

Case Pack

3

Always be prepared with the Smith & Wesson® Drive Folding Knife. The high-carbon blade is perfect for all your daily cutting tasks. Its keychain accessibility and integral bottle opener make sure you're always hydrated wherever you are.



3.3"

1117229 BLISTER UPC - 661120081135

2"

BENJI™ FOLDING KNIFE

- » 8Cr-13MoV S.S. Steel Blade
- » G10 Handle
- » Finger Flipper
- » Frame Lock
- » Ultra-Glide™
- » Tip Up Pocket Clip/Money Clip
- » Bottle Opener

Blade Length

1.5"

Overall Length

4.3"

Weight

2.72 oz.

Case Pack

3 - blister

12 - box

Perfect for your discreet EDC, this knife packs big features in a small package. This all-in-one pocket knife, money clip, and bottle opener fits cleanly into the coin pocket of your favorite jeans, so you're always prepared.



4.3"

1117230 BLISTER UPC - 661120081328
1122568 BOX UPC - 661120081302

2.8"

Smith & Wesson®

FREIGHTER™ FOLDING KNIFE

- 8Cr13MoV S.S. Steel Blade
- Stainless Steel G10 Handle
- Dual Thumb Studs
- Liner Lock
- Tip Down Pocket Clip

The Freighter liner lock folding knife is the perfect addition to your collection. Constructed from a durable stainless steel frame and equipped with a belt clip and thumb stud, this sturdy pocket knife will hold up to any task and is perfect for everyday use.

Blade Length

3.1"

Overall Length

7.6"

Weight

4.8 oz.

Case Pack

3 - blister

12 - box



7.6"

1117232 BLISTER
1122567 BOX

 UPC - 661120081104
 UPC - 661120081067

4.5"

SIDEBURN™ FOLDING KNIFE

- 8Cr13MoV S.S. Steel Blade
- G10 Handle Scales
- Finger Flipper
- Birds Eye Opener
- Liner Lock
- Ultra-Glide™
- Tip Up Pocket Clip

Don't let the lightweight and sleek design fool you from thinking it's your ordinary everyday knife. This EDC has a Modified Whamcliffe blade giving it an edge above all the rest.

Blade Length

3"

Overall Length

7.3"

Weight

2.72 oz.

Case Pack

3 - blister

12 - box



7.3"

1117236 BLISTER
1122568 BOX

 UPC - 661120081173
 UPC - 661120081166

4.1"

STAVE™ FOLDING KNIFE

- 8Cr13MoV S.S. Steel Blade
- Stainless Steel G10 Handle
- Finger Flipper
- Liner Lock
- Ultra-Glide™
- Tip Down Pocket Clip

The Stave is your ideal knife for any task. The high-carbon steel blade has a curved belly that's perfect for cutting or chopping; while the stainless steel and G10 construction make this knife ultra-tough and great looking.

Blade Length

3.3"

Overall Length

7.8"

Weight

4.16 oz.

Case Pack

3 - blister

12 - box



7.8"



1117233

BLISTER

UPC - 661120081340

1122569

BOX

UPC - 661120081333



4.5"

FREELANCER™ FOLDING KNIFE

- 8Cr13MoV S.S. Steel Blade
- G10 Handle Scales
- Button Lock/Unlock
- Tip Up Pocket Clip

This button lock clip point pocket knife is built for a smooth open. Break away from finger flippers and thumb studs for a smooth snap-open pocket knife that fits your everyday carry needs.

Blade Length

3.5"

Overall Length

8"

Weight

3.68 oz.

Case Pack

3 - blister

12 - box



8"

1117234

BLISTER

UPC - 661120081098

1122570

BOX

UPC - 661120081050



4.5"

Smith & Wesson®

VELOCITE™ ASSISTED OPENING

- » 8Cr13MoV S.S. Steel Blade
- » Textured Polymer Handle
- » Finger Flipper
- » Liner Lock
- » Tip Down Pocket Clip

This is one of our lightest EDC pocket knives. This clip point pocket knife is built with a heavily textured grip and a spring-assisted opening mechanism for a smooth open every time. Solid, sturdy, and an extremely light composition make this knife the perfect addition for an on-the-go carry.

Blade Length

3.4"

Overall Length

7.9"

Weight

3.68 oz.

Case Pack

3 - blister

12 - box



7.9"

1117237 BLISTER
1122573 BOX

 UPC - 661120081081
 UPC - 661120081036

4.5"

CLEFT™ ASSISTED OPENING

- » 8Cr13MoV S.S. Steel Blade
- » Stainless Steel G10 Handle Scales
- » Dual Thumb Studs
- » Liner Lock
- » Tip Up Pocket Clip

A hefty clip point folding knife built tough enough to handle your biggest jobs, this EDC packs a sturdy blade for heavy duty work in a compact package. Complete with a belt clip and thumb stud, this boldly distinguished and ruggedly handsome pocket knife is built to handle your toughest tasks with ease.

Blade Length

3.4"

Overall Length

7.9"

Weight

4.3 oz.

Case Pack

3 - blister

12 - box



7.9"

1117238 BLISTER
1122572 BOX

 UPC - 661120081074
 UPC - 661120081043

4.5"

FOLDING PEN KNIFE

- Stainless Steel Blade
- Aluminum Body
- Liner Lock
- Thumb Stud
- Twist-Out Writing Point
- Pocket Clip

A combination pen and pocket knife, we built this knife for finesse with its edge and with its ink. The fine blade, aluminum construction, and ball-point pen give you precise control no matter your medium to withstand extreme conditions.

Blade Length

1.6"

Overall Length

7.6"

Weight

1.92 oz.

Case Pack

12

 1117236
1122571

**BLISTER
BOX**

 UPC - 661120081319
UPC - 661120081298

KNIFE SHARPENER

- Ceramic and Carbide Sharpeners
- Glass Reinforced Nylon Body
- Tapered Diamond Honing Stone
- T8 Torx Driver
- Keychain

Never have another dull moment with our on-the-go, easily accessible knife sharpener. Always be prepared with ceramic and carbide sharpeners and a Torx driver to ensure your blades will always be in peak condition.

Overall Length

5.5"

Weight

2.08 oz.

Case Pack

3



1117198

BLISTER

UPC - 661120081142

Smith & Wesson®

HAWKEYE™ THROWING AXES

- Stainless Steel Construction
- Comes in a Set of 3
- Integrated Bottle Opener
- Nylon Sheath

Three super sharp axes are better than one. Enjoy a fun night axe throwing with a built-in bottle opener and premium steel construction. With perfectly balanced frames and a sharpened edge on three sides, you're bound to hit the bullseye every time.

Overall Length
10.3"
Case Pack
3

1117231

CLAM

UPC - 661120081128



3 Pack



Smith & Wesson®

S&W® THROWING COMBO

- Stainless Steel Construction
- 3 Pack Axes
- 3 Pack Knives
- Integrated Bottle Opener on Axes
- Nylon Sheath for Each Set

Three super sharp axes combined with three precision throwing knives make the perfect throwing combo.

1122228
BOX

UPC - 661120081111

Overall Length Axes

10.3"

Overall Length Knives

8"

Case Pack

3

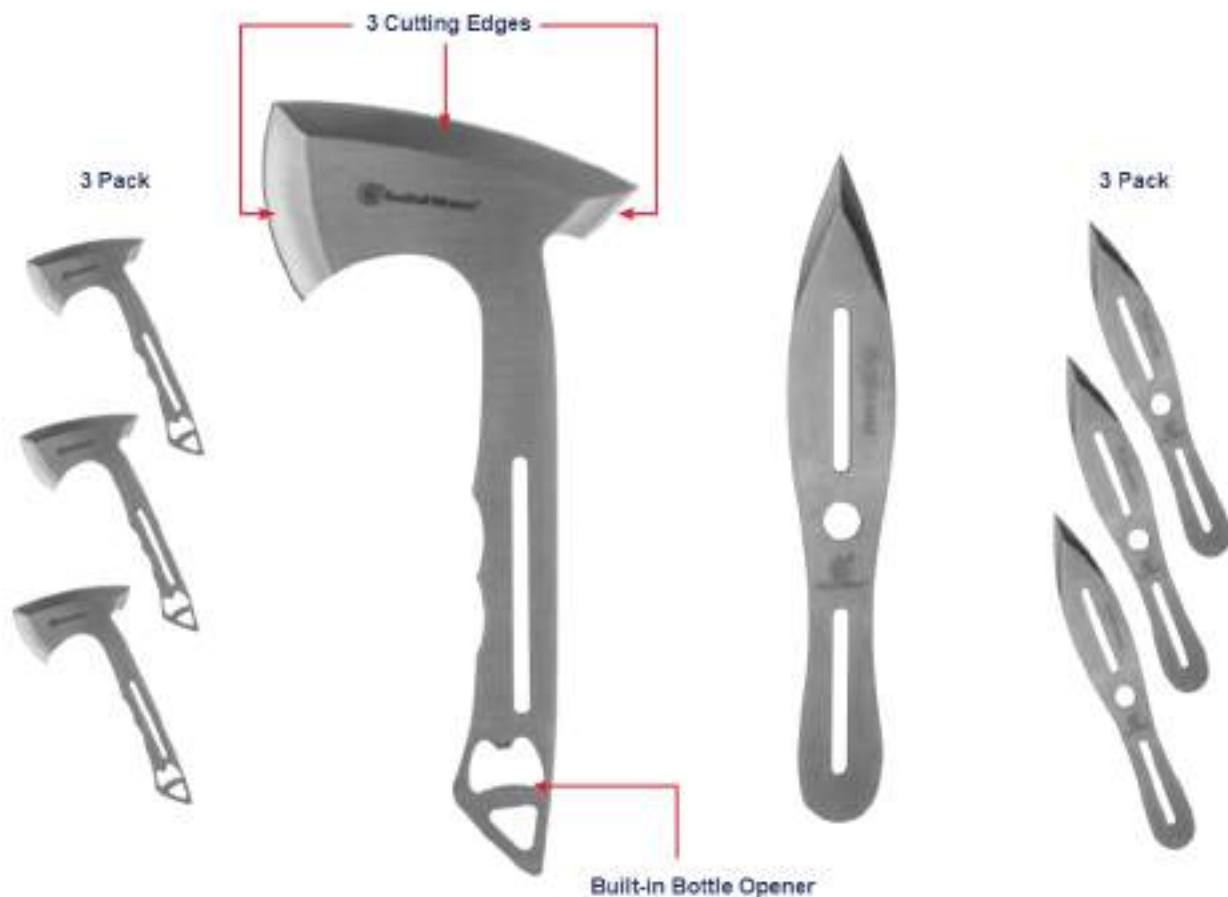

Smith & Wesson®

VEHICLE ESCAPE TOOL

- » Seatbelt Cutter
- » Glass Breaker
- » Solid All Metal Construction
- » 2 Port USB Chargers

Overall Length
2.6"

Weight
2.24 oz.

Case Pack
12



This tool is the ultimate copilot when it comes to emergencies on the road. With a built-in seatbelt cutter and a hardened glass breaking hammer, its small but mighty aluminum construction will always have your back no matter what. And when you don't need it to save your life, it will save the life of your electronics with dual USB charging ports.

1117238

BLISTER UPC - 681120081357

2.4A and 1.0A USB Chargers



Seatbelt Cutter



Tungsten Glass Breaker



2.6"

Smith & Wesson®

QUICK RELEASE BATONS

- 4140 Steel Construction
- Rubberized Grip Handles
- Push Button Collapsing
- Threaded End Caps
- 360° Rotating Synthetic Sheath

This steel construction baton enables you to always be at the ready. With push-button collapsing, it is easy to deploy and retract. The baton easily collapses into a compact size for easy carrying and a rapid deployment.

	1117242	21" BATON	BOX	UPC - 661120081180
	1117241	24" BATON	BOX	UPC - 661120081197

Handle Length

21" Baton - 6"

24" Baton - 7"

Weight

21" Baton - 22.09 oz.

24" Baton - 24.16 oz.

Case Pack

8

24" Expanded Length

21" Expanded Length



360° Rotating Sheath



PUSH BUTTON COLLAPSING: Once deployed, simply push the button on the back of the baton to release and collapse.

Smith & Wesson®

S&W ASSISTED OPENING

**8Cr13MoV BLACK OXIDE COATED HIGH CARBON S.S. BLADE
RUBBERIZED ALUMINUM HANDLE**

- Thumbstud
- Liner Lock
- Pocket Clip

Blade Length
3.25" (8.255 cm)
Overall Length
7.75" (19.685 cm)
Weight
4.4 oz.



7.75"

1100036 **S&W S.A. OD GREEN BOX**
UPC - 661120075967

1100037 **S&W S.A. OD GREEN CLAM**
UPC - 661120075974



4.5"

S&W ASSISTED OPENING

**8Cr13MoV BLACK OXIDE COATED HIGH CARBON S.S. BLADE
RUBBERIZED ALUMINUM HANDLE**

- Thumbstud
- Liner Lock
- Pocket Clip
- Tungsten Window Punch
- Seat Belt Cutter

Blade Length
3.25" (8.255 cm)
Overall Length
8" (20.32 cm)
Weight
4.7 oz.



8"

1100038 **S&W S.A. OD RED ACCENT BOX**
UPC - 661120075981

1100039 **S&W S.A. OD RED ACCENT CLAM**
UPC - 661120075998



4.75"

S&W ASSISTED OPENING

**8Cr13MoV BLACK OXIDE COATED HIGH CARBON S.S. BLADE
RUBBERIZED ALUMINUM HANDLE**

- Thumbstud
- Liner Lock
- Pocket Clip
- Lanyard Hole

Blade Length
3.5" (8.89 cm)
Overall Length
8.5" (21.59 cm)
Weight
5.2 oz.



8.5"



5"

1100058 S&W SWAT II BOX

UPC - 661120076001

1100058 S&W SWAT II CLAM

UPC - 661120076018

S&W STONEWASH
STAINLESS STEEL BLADE, STONEWASH FINISH

- Stonewash Coating
- Money Clip
- Nail Nick
- Frame Lock
- Thumbstud
- Pocket Clip
- Bottle Opener
- Keychain Lanyard

Blade Length
2.25" (5.715 cm)
Overall Length
5.25" (13.335 cm)
Weight
2.4 oz.



5.25"



3.25"

1100064 S&W STONEWASH BOX

UPC - 661120076063

1100065 S&W STONEWASH CLAM

UPC - 661120076070

S&W NYLON BLUE

8Cr13MoV BEAD BLAST FINISHED HIGH CARBON S.S. BLADE,
 NYLON HANDLE

- G-10 Texture
- Finger Flipper
- Pocket Clip
- Liner Lock
- Thumbstud

Blade Length
 2.75" (6.985 cm)
 Overall Length
 6" (15.24 cm)
 Weight
 2.5 oz.



1100066 S&W NYLON BLUE BOX
 UPC - 661120076087

1100067 S&W NYLON BLUE CLAM
 UPC - 661120076094

S&W CLIP FOLD W KEYCHAIN

8Cr13MoV BLACK OXIDE COATED HIGH CARBON S.S. BLADE
 POLYMER HANDLE

- **FREE KEYCHAIN BOTTLE OPENER**
- Pocket Clip
- Liner Lock
- Thumbstud

Blade Length
 3.25" (8.255 cm)
 Overall Length
 7.65" (19.431 cm)
 Weight
 3.7 oz.



1100050 S&W CLIP FOLD W KEYCHAIN BOX
 UPC - 661120076025

1100051 S&W CLIP FOLD W KEYCHAIN CLAM
 UPC - 661120076032



S&W CLIP FOLD W G10
8Cr13MoV S.S. BLADE, G10 HANDLE

- » Finger Flipper
- » Liner Lock
- » Pocket Clip
- » Thumbstud
- » Lanyard Hole

Blade Length
3.25" (8.255 cm)
Overall Length
7.75" (19.685 cm)
Weight
4.7 oz.



7.75"



4.5"

1100062 S&W CLIP FOLD W G10 BOX

UPC - 661120076049

1100063 S&W CLIP FOLD W G10 CLAM

UPC - 661120076056

S&W 2.75 FDE BOOT KNIFE
**8Cr13MoV BLACK OXIDE COATED HIGH CARBON S.S. BLADE
RUBBERIZED HANDLE**

- » Single Edge
- » Finger Guards
- » Hard Polymer Sheath Included

Blade Length
2.75" (6.985 cm)
Overall Length
6.25" (15.875 cm)
Weight
1.8 oz.



6.25"



6.75"

1100072 S&W 2.75 FDE BOOT KNIFE BOX

UPC - 661120076124

1100073 S&W 2.75 FDE BOOT KNIFE CLAM

UPC - 661120076131

S&W SEARCH AND RESCUE
**8Cr13MoV BLACK OXIDE COATED HIGH CARBON S.S. BLADE
RUBBERIZED HANDLE**

- Partial Serration
- Blood Groove
- Tungsten Window Punch
- Sharpener Included
- Sheath Included

Blade Length
6" (15.24 cm)
Overall Length
11" (27.94 cm)
Weight
5.9 oz.



11"

1100070 S&W SEARCH AND RESCUE BOX

UPC - 661120076100

1100071 S&W SEARCH AND RESCUE CLAM

UPC - 661120076117

S&W COLLAPSIBLE BATONS
4130 SEAMLESS ALLOY STEEL TUBING

- Textured and Raised Rubber Handle
- HRC Rockwell Hardness 46-47
- 360-Degree Sheath
- Patent-Pending Window Punch
- Tensile Strength 6639 lbf (3011 kgf)
- Bending Strength 4056 lbf (1840 kgf)

Weight & Overall Length
1 lb. 4 oz. 21"
1 lb. 7 oz. 26"



21"



26"

1100094 21" BATON BOX

UPC - 661120076148

1100095 21" BATON CLAM

UPC - 661120076155

1100096 26" BATON BOX

UPC - 661120076162

1100097 26" BATON CLAM

UPC - 661120076179



**AUS-8 STEEL BLADE
ALUMINUM HANDLE**

- Blade Release
- Safety Lock
- Glass Breaker
- Blade Slider
- Pocket Clip



SW0TF9B

SMITH & WESSON® OUT THE FRONT



Blade Length
3.6" (9.1 cm)
Overall Length
8.8" (22.3 cm)
Weight
6 oz.



SW0TF9B DAGGER POINT BLADE GREY HANDLE BOX

UPC - 028834709762

SW0TF9BS DAGGER POINT SERRATED BLADE GREY HANDLE BOX

UPC - 028834709779

SW0TF9TB TANTO POINT BLADE GREY HANDLE BOX

UPC - 028834709786

SW0TF9TBS TANTO POINT SERRATED BLADE GREY HANDLE BOX

UPC - 028834709793

No Ship CA, NY & MA
For All Options



Serrated Blade Option



Tanto Blade Option



Tanto Serrated Blade Option





ASSISTED OPENING

8Cr13MoV BLACK OXIDE COATED HIGH CARBON S.S. BLADE
RUBBERIZED ALUMINUM HANDLE

- Dual Thumbstuds
- Liner Lock
- Pocket Clip

Blade Length
3.5" (8.89 cm)
Overall Length
8" (20.5 cm)
Weight
4.8 oz.



8"



4.72"

1084302 DROP POINT BLACK/FDE HANDLE BOX
UPC - 661120413839

1084303 DROP POINT BLACK/FDE HANDLE CLAM
UPC - 661120413288

ASSISTED OPENING

8Cr13MoV BLACK OXIDE COATED HIGH CARBON S.S. BLADE
ALUMINUM TEXTURED HANDLE

- Dual Thumbstuds
- Liner Lock
- Pocket Clip
- Lanyard Hole

Blade Length
3.25" (8.26 cm)
Overall Length
6.89" (17.5 cm)
Weight
4.2 oz.



6.89"



3.94"

1084304 DROP POINT BLACK HANDLE BOX
UPC - 661120413295

1084305 DROP POINT BLACK HANDLE CLAM
UPC - 661120413301



4034 BLACK OXIDE S.S. BLADE
ALUMINUM HANDLE

- » M.A.G.I.C. Assisted Opening
- » Finger Actuator
- » Dual Thumb Knobs
- » Liner Lock
- » Safety Lock
- » Pocket Clip

SWBLOP3

SMITH & WESSON® BLACK OPS®



Blade Length
3.4" (8.6 cm)
Overall Length
7.7" (19.5 cm)
Weight
4.8 oz.



7.7"

SWBLOP3 DROP POINT BLADE SILVER HANDLE BOX
UPC - 028634703524

SWBLOP3CP DROP POINT BLADE SILVER HANDLE CLAM
UPC - 028634704310

SWBLOP3S DROP POINT SERRATED BLADE SILVER HANDLE BOX
UPC - 028634703531

SWBLOP3SCP DROP POINT SERRATED BLADE SILVER HANDLE CLAM
UPC - 028634704354

SWBLOP3T TANTO POINT BLADE SILVER HANDLE BOX
UPC - 028634703548

SWBLOP3TS TANTO POINT SERRATED BLADE SILVER HANDLE BOX
UPC - 028634703555

SWBLOP3TSCP TANTO POINT SERRATED BLADE SILVER HANDLE CLAM
UPC - 028634704446



Serrated Blade Option



Tanto Blade Option



Tanto Serrated Blade Option



4.3"



SWBLOP3TD

SMITH & WESSON® BLACK OPS®

**SMITH & WESSON®
BLACK OPS®**

Blade Length
3.4" (8.6 cm)
Overall Length
7.7" (19.5 cm)
Weight
4.8 oz.
UPC
028634706372



7.7"



4.3"

SMITH & WESSON® BLACK OPS®

**SMITH & WESSON®
BLACK OPS®**

Blade Length
3.4" (8.6 cm)
Overall Length
7.7" (19.5 cm)
Weight
4.8 oz.



7.7"



Serrated Blade Option

SWBLOP3TBL TANTO POINT BLADE BLUE/BLACK HANDLE BOX

UPC - 028634704040

SWBLOP3TBL5 TANTO POINT SERRATED BLADE BLUE/BLACK HANDLE BOX

UPC - 028634704057



4.3"

SMITH & WESSON® BLACK OPS®

**SMITH & WESSON®
BLACK OPS®**

Blade Length
3.4" (8.6 cm)
Overall Length
7.7" (19.5 cm)
Weight
4.8 oz.



7.7"



Serrated Blade Option

SWBLOP3R DROP POINT BLADE RED/BLACK HANDLE BOX

UPC - 028634704026

SWBLOP3R5 DROP POINT SERRATED BLADE RED/BLACK HANDLE BOX

UPC - 028634704033



4.3"

**4034 BLACK OXIDE S.S. BLADE
ALUMINUM HANDLE**

- » M.A.G.I.C. Assisted Opening
- » Finger Actuator
- » Dual Thumb Knobs
- » Liner Lock
- » Safety Lock
- » Pocket Clip

SWBLOP3SMP
SMITH & WESSON® BLACK OPS®

Blade Length
2.5" (6.3cm)
Overall Length
5.8" (14.7 cm)
Weight
2.6 oz.



5.8"



3.3"

SWBLOP3SMP DROP POINT BLADE PINK HANDLE BOX

UPC - 028634705993

SWBLOP3SMPCP DROP POINT BLADE PINK HANDLE CLAM

UPC - 028634705795

SWBLOP3SMS
SMITH & WESSON® BLACK OPS®

Blade Length
2.5" (6.3cm)
Overall Length
5.8" (14.7 cm)
Weight
2.6 oz.



5.8"

Tanto Blade Option

3.3"

SWBLOP3SMS DROP POINT SERRATED BLADE SILVER HANDLE BOX

UPC - 028634705841

SWBLOP3SMSCP DROP POINT SERRATED BLADE SILVER HANDLE CLAM

UPC - 028634705702

SWBLOP3SMT TANTO POINT BLADE SILVER HANDLE BOX

UPC - 028634705658



4034 BLACK OXIDE S.S. BLADE
ALUMINUM HANDLE

- » M.A.G.I.C. Assisted Opening
- » Finger Actuator
- » Dual Thumb Knobs
- » Liner Lock
- » Safety Lock
- » Pocket Clip

SMITH & WESSON® BLACK OPS®



Blade Length
2.6" (6.6 cm)
Overall Length
5.9" (15.0 cm)
Weight
2.3 oz.



5.9"



3.3"

SWBLOP2SMB S DROP POINT SERRATED BLADE BLACK HANDLE BOX
UPC - 029834705603

SWBLOP2SMBSCP DROP POINT SERRATED BLADE BLACK HANDLE CLAM
UPC - 029834705685

SWBLOP2B

SMITH & WESSON® BLACK OPS®



Blade Length
3.4" (8.6 cm)
Overall Length
7.7" (19.5 cm)
Weight
4.2 oz.



7.7"



Serrated Blade Option



4.3"

SWBLOP2B DROP POINT BLADE BLACK HANDLE BOX
UPC - 029834702398

SWBLOP2BS DROP POINT SERRATED BLADE BLACK HANDLE BOX
UPC - 029834702404

SWBLOP2BSCP DROP POINT SERRATED BLADE BLACK HANDLE CLAM
UPC - 029834702909



SWBLOP4

SMITH & WESSON® BLACK OPS®



**4034 S.S. BLADE
ALUMINUM HANDLE**

- M.A.G.I.C. Assisted Opening
- Finger Actuator
- Dual Thumb Knobs
- Liner Lock
- Safety Lock
- Reversible Pocket Clip

Blade Length
3.3" (8.4 cm)
Overall Length
7.7" (19.5 cm)
Weight
4.9 oz.



SWBLOP4 DROP POINT BLADE GREY HANDLE BOX
UPC - 028634704934

SWBLOP4BS DROP POINT BLACK SERRATED BLADE GREY HANDLE BOX
UPC - 028634704965



Serrated Blade Option



Reversible Pocket Clip



4.4"



4034 BLACK OXIDE S.S. BLADE
ALUMINUM HANDLE

- M.A.G.I.C. Assisted Opening
- Finger Actuator
- Dual Thumb Knobs
- Liner Lock
- Safety Lock
- Pocket Clip

SPECM

SMITH & WESSON® SPECIAL OPS®

Blade Length
3.1" (7.9 cm)
Overall Length
7.4" (18.8 cm)
Weight
4.1 oz.



SPECM TANTO POINT BLADE GREY/BLACK HANDLE BOX
UPC - 028634701322

SPECM8 TANTO POINT SERRATED BLADE GREY/BLACK HANDLE BOX
UPC - 028634701339



Serrated Blade Option



4.2"

SMITH & WESSON® SPECIAL OPS®



Blade Length
3.7" (9.4 cm)
Overall Length
8.5" (21.6 cm)
Weight
5 oz.



8.5"



Serrated Blade Option



4.8"

B5PECLCP TANTO POINT BLADE BLACK HANDLE CLAM
UPC - 028634704323

B5PECLSCP TANTO POINT SERRATED BLADE BLACK HANDLE CLAM
UPC - 028634704330



4034 BLACK OXIDE S.S. BLADE
ALUMINUM HANDLE

- M.A.G.I.C. Assisted Opening
- Finger Actuator
- Dual Thumb Knobs
- Liner Lock
- Safety Lock
- Pocket Clip

SWATB

SMITH & WESSON® S.W.A.T.®

Blade Length
2.5" (6.3 cm)
Overall Length
5.8" (14.7 cm)
Weight
2.3 oz.



Serrated Blade Option



3.3"

SWATB DROP POINT BLADE BLACK HANDLE BOX
UPC - 028634700752

SWATBCP DROP POINT BLADE BLACK HANDLE CLAM
UPC - 028634703470

SWATBS DROP POINT SERRATED BLADE BLACK HANDLE BOX
UPC - 028634700769

SWATMB

SMITH & WESSON® S.W.A.T.®

Blade Length
3.2" (8.2 cm)
Overall Length
7.5" (19.0 cm)
Weight
3.9 oz.



Serrated Blade Option



4.3"

SWATMB DROP POINT BLADE BLACK HANDLE BOX
UPC - 028634700165

SWATMBCP DROP POINT BLADE BLACK HANDLE CLAM
UPC - 028634703722

SWATMBS DROP POINT SERRATED BLADE BLACK HANDLE BOX
UPC - 028634700172



4034 BLACK OXIDE S.S. BLADE
ALUMINUM HANDLE

- M.A.G.I.C. Assisted Opening
- Finger Actuator
- Dual Thumb Knobs
- Liner Lock
- Safety Lock
- Pocket Clip

SWATLB

SMITH & WESSON® S.W.A.T.®



Blade Length
3.7" (9.4 cm)
Overall Length
8.5" (21.7 cm)
Weight
5.8 oz.



8.5"

SWATLB DROP POINT BLADE BLACK HANDLE BOX
UPC - 028634700714

SWATLBS DROP POINT SERRATED BLADE BLACK HANDLE BOX
UPC - 028634700721



Serrated Blade Option



4.8"

SW6000B

SMITH & WESSON® ASSISTED OPENING



Blade Length
3.3" (8.4 cm)
Overall Length
7.7" (19.6 cm)
Weight
3.7 oz.



7.7"

SW6000B DROP POINT BLADE GREY HANDLE BOX
UPC - 028634707348

SW6000BS DROP POINT SERRATED BLADE GREY HANDLE BOX
UPC - 028634707362

SW6000BSCP DROP POINT SERRATED BLADE GREY HANDLE CLAM
UPC - 028634707379



Serrated Blade Option



4.4"



4034 BLACK OXIDE S.S. BLADE
NYLON FIBER HANDLE

- M.A.G.I.C. Assisted Opening
- Finger Actuator
- Dual Thumb Knobs
- Liner Lock
- Safety Lock
- Spring-Loaded Glass Punch
- Pocket Clip

SW911B

SMITH & WESSON® 1ST RESPONSE®

Blade Length
3.4" (8.6 cm)
Overall Length
8.2" (20.8 cm)
Weight
4.9 oz.
UPC
028634702176



SW911H

SMITH & WESSON® 1ST RESPONSE®

Blade Length
3.4" (8.6 cm)
Overall Length
8.2" (20.8 cm)
Weight
4.9 oz.
UPC
028634702077





SMITH & WESSON® FOLDING KNIFE

8Cr13MoV BLACK OXIDE COATED HIGH CARBON S.S. BLADE
RUBBERIZED TEXTURED ALUMINUM HANDLE

- Dual Thumbstuds
- Finger Flipper
- Liner Lock
- Pocket Clip
- Lanyard Hole

Blade Length
3" (7.62 cm)
Overall Length
6.89" (17.5 cm)
Weight
4.4 oz.



1084308 DROP POINT RUBBERIZED BLACK HANDLE BOX
UPC - 661120413332

1084309 DROP POINT RUBBERIZED BLACK HANDLE CLAM
UPC - 661120413340

SMITH & WESSON® FOLDING KNIFE

8Cr13MoV BLACK OXIDE COATED HIGH CARBON S.S. BLADE
RUBBERIZED TEXTURED ALUMINUM HANDLE

- Dual Thumbstuds
- Finger Flipper
- Liner Lock
- Pocket Clip

Blade Length
3.5" (8.89 cm)
Overall Length
8.07" (20.5 cm)
Weight
3.9 oz.



1084310 TANTO POINT RUBBERIZED BLACK HANDLE BOX
UPC - 661120413356

1084311 TANTO POINT RUBBERIZED BLACK HANDLE CLAM
UPC - 661120413363



SMITH & WESSON® FOLDING KNIFE

8Cr13MoV BLACK OXIDE COATED HIGH CARBON S.S. BLADE
GLASS FILLED TEXTURED NYLON HANDLE

- Dual Thumbstuds
- Finger Flipper
- Liner Lock
- Pocket Clip

Blade Length
3.5" (8.89 cm)
Overall Length
8.07" (20.5 cm)
Weight
3.7 oz.



8.07"



4.53"

1084312 DROP POINT FDE NYLON HANDLE BOX
UPC - 661120413677

1084313 DROP POINT FDE NYLON HANDLE CLAM
UPC - 661120413684

SMITH & WESSON® FOLDING KNIFE

8Cr13MoV SATIN FINISH HIGH CARBON S.S. BLADE
ALUMINUM W/TEXTURED INSERT HANDLE

- Dual Thumbstuds
- Finger Flipper
- Frame Lock
- Pocket Clip
- Lanyard Hole

Blade Length
2.75" (6.99 cm)
Overall Length
6.3" (16.0 cm)
Weight
3.1 oz.



6.3"



3.74"

1084306 DROP POINT SILVER/BLACK HANDLE BOX
UPC - 661120413318

1084307 DROP POINT SILVER/BLACK HANDLE CLAM
UPC - 661120413325



SWFR

SMITH & WESSON® 1ST RESPONSE®

**7Cr17MoV HIGH CARBON S.S. BLADE
S.S. WITH G-10 INLAY HANDLE**

- Thumb Plate
- Liner Lock
- Strap Cutter
- Glass Breaker
- Pocket Clip

Blade Length
3.3" (8.4 cm)
Overall Length
8" (20.3 cm)
Weight
5.8 oz.



8"



Serrated Blade Option



4.7"

SWFR DROP POINT BLADE SILVER/BLACK HANDLE BOX
UPC - 028634700677

SWFRS DROP POINT SERRATED BLADE SILVER/BLACK HANDLE BOX
UPC - 028634700684

SWFRSCP DROP POINT SERRATED BLADE SILVER/BLACK HANDLE CLAM
UPC - 028634701391

SWFR2S

SMITH & WESSON® EXTREME OPS®

**7Cr17MoV HIGH CARBON BLACK OXIDE S.S. BLADE
ALUMINUM HANDLE**

- Dual Thumb Knobs
- Liner Lock
- Strap Cutter
- Glass Breaker
- Pocket Clip

Blade Length
3.3" (8.4 cm)
Overall Length
8" (20.3 cm)
Weight
4.4 oz.



8"



4.7"

SWFR2S TANTO POINT SERRATED BLADE BLACK HANDLE BOX
UPC - 028634701605

SWFR2SCP TANTO POINT SERRATED BLADE BLACK HANDLE CLAM
UPC - 028634706174



8Cr13MoV HIGH CARBON BLACK OXIDE S.S. BLADE
ALUMINUM HANDLE

- Liner Lock
- Strap Cutter
- Pocket Clip
- Index Flipper
- Glass Breaker

SW608S

SMITH & WESSON® FOLDING KNIFE

Blade Length
3.4" (8.7 cm)
Overall Length
8.5" (21.5 cm)
Weight
4.3 oz.
UPC
028634709175



SW608BS

SMITH & WESSON® FOLDING KNIFE

Blade Length
3.4" (8.7 cm)
Overall Length
8.5" (21.5 cm)
Weight
4.3 oz.
UPC
028634709199



SW608RS

SMITH & WESSON® FOLDING KNIFE

Blade Length
3.4" (8.7 cm)
Overall Length
8.5" (21.5 cm)
Weight
4.3 oz.
UPC
028634709397





SW609

SMITH & WESSON® FOLDING KNIFE

**8Cr13MoV STONEWASH HIGH CARBON S.S. BLADE
STONEWASH S.S. W/G-10 HANDLE**

- Dual Thumb Knobs
- Frame Lock
- Index Flipper
- Pocket Clip

Blade Length
3.6" (9.0 cm)
Overall Length
8.3" (21.0 cm)
Weight
5.9 oz.



8.3"



4.75"

SW609 DROP POINT BLADE FDE HANDLE BOX
UPC - 028634709212

SW609CP DROP POINT BLADE FDE HANDLE CLAM
UPC - 028634709229

SW612S

SMITH & WESSON® FOLDING KNIFE

**8Cr13MoV HIGH CARBON BLACK OXIDE S.S. BLADE
TPE HANDLE**

- Dual Thumb Knobs
- Liner Lock
- Pocket Clip

Blade Length
3.6" (9.0 cm)
Overall Length
8.3" (21.0 cm)
Weight
5.3 oz.



8.3"



4.75"

SW612S TANTO POINT SERRATED BLADE SILVER/BLACK HANDLE BOX
UPC - 028634709373

SW612SCP TANTO POINT SERRATED BLADE SILVER/BLACK HANDLE CLAM
UPC - 028634709380



SWBG10S

SMITH & WESSON® BORDER GUARD®

**7Cr17MoV STONEWASH HIGH CARBON S.S. BLADE
STONEWASH ALUMINUM G-10 INSERT HANDLE**

- Dual Thumb Knobs
- Liner Lock
- Index Flipper
- Strap Cutter
- Glass Breaker
- Pocket Clip

Blade Length
3.5" (8.9 cm)
Overall Length
8.3" (21.0 cm)
Weight
6 oz.



8.3"



4.8"

SWBG10S TANTO POINT SERRATED BLADE GREY/BLACK HANDLE BOX
UPC - 029634708550

SWBG10SCP TANTO POINT SERRATED BLADE GREY/BLACK HANDLE CLAM
UPC - 029634708888

SWBG6TS

SMITH & WESSON® BORDER GUARD®

**7Cr17MoV HIGH CARBON BLACK OXIDE S.S. BLADE
G-10 HANDLE**

- Dual Thumb Knobs
- Liner Lock
- Strap Cutter
- Glass Breaker
- Pocket Clip

Blade Length
4.2" (10.6 cm)
Overall Length
10.1" (25.6 cm)
Weight
9.2 oz.
UPC
029634708266



10.1"



5.9"



7Cr17MoV HIGH CARBON BLACK OXIDE S.S. BLADE
ALUMINUM HANDLE

- Dual Thumb Knobs
- Glass Breaker
- Liner Lock
- Pocket Clip
- Strap Cutter

SWBG1

SMITH & WESSON® BORDER GUARD®

Blade Length
4.4" (11.2 cm)
Overall Length
10" (25.4 cm)
Weight
8.8 oz.



10"

SWBG1 DROP POINT BLADE BLACK HANDLE BOX
UPC - 028634702435

SWBG1S DROP POINT SERRATED BLADE BLACK HANDLE BOX
UPC - 028634702442



Serrated Blade Option



5.6"

SWBG2T

SMITH & WESSON® BORDER GUARD®

Blade Length
4.4" (11.2 cm)
Overall Length
10" (25.4 cm)
Weight
8.8 oz.



10"

SWBG2T TANTO POINT BLADE BLACK HANDLE BOX
UPC - 028634702459

SWBG2TS TANTO POINT SERRATED BLADE BLACK HANDLE BOX
UPC - 028634702466



Serrated Blade Option



5.6"



SWBG7

SMITH & WESSON® BORDER GUARD®

7Cr17MoV HIGH CARBON S.S. BLADE

S.S. HANDLE

- Dual Thumb Knobs
- Liner Lock
- Strap Cutter
- Ceramic Glass Breaker
- Pocket Clip

Blade Length
4.3" (11.0 cm)

Overall Length
10.2" (25.8 cm)

Weight
11.6 oz.



10.2"



5.9"

SWBG7 DROP POINT BLADE STONEWASHED/TAN HANDLE BOX
UPC - 029834707584





8Cr13MoV HIGH CARBON S.S. BLADE
ALUMINUM HANDLE

- Dual Thumb Knobs
- Index Flipper
- Liner Lock
- Pocket Clip

SW607S

SMITH & WESSON® FOLDING KNIFE

Blade Length
3.6" (9.0 cm)
Overall Length
8.4" (21.2 cm)
Weight
4.4 oz.



SW607S DROP POINT SERRATED BLADE SILVER/BLACK HANDLE BOX
UPC - 028634709151

SW607SCP DROP POINT SERRATED BLADE SILVER/BLACK HANDLE CLAM
UPC - 028634709168

7Cr17MoV HIGH CARBON BLACK OXIDE S.S. BLADE
ALUMINUM HANDLE

- Push Button Lock
- Safety Lock
- Pocket Clip

SW50B

SMITH & WESSON® EXTREME OPS®

Blade Length
3.3" (8.3 cm)
Overall Length
7.8" (19.8 cm)
Weight
4.5 oz.



Drop Point Serrated Blade Option



Tanto Blade Option



Tanto Serrated Blade Option



SW50B DROP POINT BLADE BLACK HANDLE BOX
UPC - 028634500017

SW50BS DROP POINT SERRATED BLADE BLACK HANDLE BOX
UPC - 028634500024

SW50BT TANTO POINT BLADE BLACK HANDLE BOX
UPC - 028634500031

SW50BTS TANTO POINT SERRATED BLADE BLACK HANDLE BOX
UPC - 028634500048



CK5TBS

SMITH & WESSON® EXTREME OPS®

**7Cr17MoV HIGH CARBON BLACK OXIDE S.S. BLADE
ALUMINUM HANDLE**

- Dual Thumb Knobs
- Liner Lock
- Pocket Clip

Blade Length
3.2" (8.2 cm)
Overall Length
7.4" (18.7 cm)
Weight
2.9 oz.



7.4"



4.1"

CK5TB8 TANTO POINT SERRATED BLADE BLACK HANDLE BOX
UPC - 028634105649

CK5TBSCP TANTO POINT SERRATED BLADE BLACK HANDLE CLAM
UPC - 028634105656

CK5TBS0

SMITH & WESSON® EXTREME OPS®

**7Cr17MoV HIGH CARBON BLACK OXIDE S.S. BLADE
ALUMINUM HANDLE**

- Dual Thumb Knobs
- Liner Lock
- Pocket Clip

Blade Length
3.2" (8.2 cm)
Overall Length
7.4" (18.7 cm)
Weight
2.9 oz.
UPC
028634000616



7.4"



4.1"

CK13T

SMITH & WESSON® EXTREME OPS®

**7Cr17MoV HIGH CARBON S.S. BLADE
G-10 HANDLE**

- Dual Thumb Knobs
- Liner Lock
- Pocket Clip

Blade Length
3.3" (8.4 cm)
Overall Length
7.8" (19.8 cm)
Weight
3.7 oz.



7.8"



4.5"

CK13T TANTO POINT BLADE BLACK HANDLE BOX
UPC - 028634705320

CK13TCP TANTO POINT BLADE BLACK HANDLE CLAM
UPC - 028634705115



7Cr17MoV HIGH CARBON S.S. BLADE
ALUMINUM HANDLE

- Push Button Lock
- Safety Lock
- Pocket Clip

CK105BK

SMITH & WESSON® EXTREME OPS®

Blade Length
3.2" (8.2 cm)
Overall Length
7.3" (18.5 cm)
Weight
2.9 oz



CK105BK DROP POINT BLADE BLACK HANDLE BOX
UPC - 028634702503

CK105BKCP DROP POINT BLADE BLACK HANDLE CLAM
UPC - 028634704125



CK105BL

SMITH & WESSON® EXTREME OPS®

Blade Length
3.2" (8.2 cm)
Overall Length
7.3" (18.5 cm)
Weight
2.9 oz



CK105BL DROP POINT BLADE BLUE HANDLE BOX
UPC - 028634105632

CK105BLCP DROP POINT BLADE BLUE HANDLE CLAM
UPC - 028634105625



CK105H

SMITH & WESSON® EXTREME OPS®

Blade Length
3.2" (8.2 cm)
Overall Length
7.3" (18.5 cm)
Weight
2.9 oz



CK105H DROP POINT BLADE SILVER HANDLE BOX
UPC - 028634105663

CK105HCP DROP POINT BLADE SILVER HANDLE CLAM
UPC - 028634105667





CK105BKEU

SMITH & WESSON® EXTREME OPS®

**7Cr17MoV HIGH CARBON BLACK OXIDE S.S. BLADE
ALUMINUM HANDLE**

- Nail Groove
- Lockback
- Pocket Clip

Blade Length
3.4" (8.6 cm)
Overall Length
8" (20.2 cm)
Weight
4.6 oz.
UPC
028634703401



SMITH & WESSON® EXTREME OPS®

**7Cr17MoV HIGH CARBON BLACK OXIDE S.S. BLADE
ALUMINUM HANDLE**

- Dual Thumb Knobs
- Liner Lock
- Pocket Clip

Blade Length
3.2" (8.1 cm)
Overall Length
7.3" (18.5 cm)
Weight
2.9 oz.



CK105HD DROP POINT BLADE TAN HANDLE BOX
UPC - 028634000593

CK105HDCP DROP POINT BLADE TAN HANDLE CLAM
UPC - 028634705122

SMITH & WESSON® EXTREME OPS®

**7Cr17MoV HIGH CARBON BLACK OXIDE S.S. BLADE
ALUMINUM HANDLE**

- Dual Thumb Knobs
- Liner Lock
- Pocket Clip

Blade Length
3.1" (7.8 cm)
Overall Length
7.3" (18.5 cm)
Weight
2.8 oz.



CK111 CLIP POINT BLADE BLACK/BLUE HANDLE BOX
UPC - 028634700455

CK111S CLIP POINT SERRATED BLADE BLACK/BLUE HANDLE BOX
UPC - 028634700462



TITANIUM COATED 7Cr17MoV HIGH CARBON S.S. BLADE
TITANIUM COATED S.S. HANDLE

- Dual Thumb Knobs
- Frame Lock
- Pocket Clip



CK110B

SMITH & WESSON® EXECUTIVE™

Blade Length
2.8" (7.1 cm)
Overall Length
6.8" (17.3 cm)
Weight
3.5 oz
UPC
029634700448



CK110GL

SMITH & WESSON® EXECUTIVE™

Blade Length
2.8" (7.1 cm)
Overall Length
6.8" (17.3 cm)
Weight
3.5 oz
UPC
029634700431



CK108
SMITH & WESSON® 24/7®
**7Cr17MoV HIGH CARBON S.S. BLADE
ALUMINUM HANDLE**

- Thumb Hole
- Lockback
- Pocket Clip

Blade Length
2.9" (7.4 cm)
Overall Length
7.2" (18.3 cm)
Weight
2.8 oz.
UPC
028634700417

CK109
SMITH & WESSON® 24/7®
**7Cr17MoV HIGH CARBON S.S. BLADE
ALUMINUM HANDLE**

- Dual Thumb Knobs
- Lockback
- Pocket Clip

Blade Length
3" (7.6 cm)
Overall Length
7.4" (18.7 cm)
Weight
2.8 oz.
UPC
028634700424

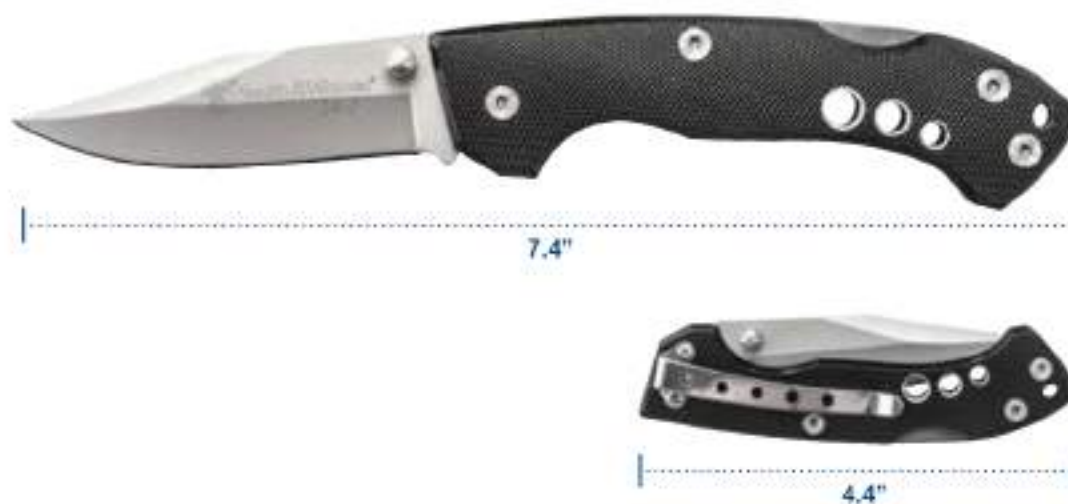



**7Cr17MoV HIGH CARBON S.S. BLADE
S.S. HANDLE**

- Dual Thumb Knobs
- Frame Lock
- Pocket Clip

CK117B

SMITH & WESSON® FOLDING KNIFE

Blade Length
2.9" (7.4 cm)
Overall Length
7.1" (18.0 cm)
Weight
4 oz
UPC
028634708819

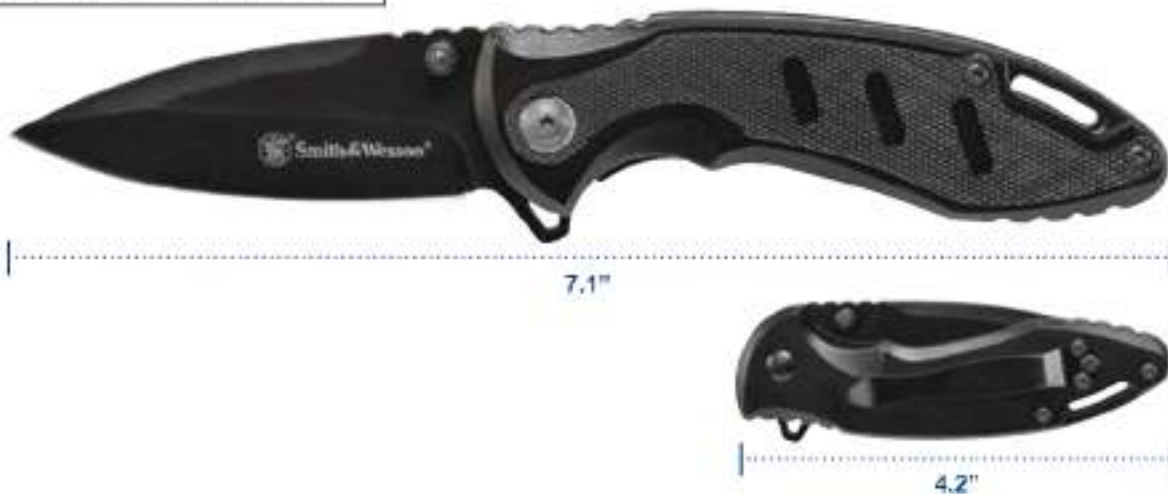

CK108BS

SMITH & WESSON® EXTREME OPS®

Blade Length
3.4" (8.6 cm)
Overall Length
7.8" (19.8 cm)
Weight
3.9 oz.
UPC
028634700806





7Cr17MoV HIGH CARBON BLACK OXIDE S.S. BLADE
ALUMINUM HANDLE

- Dual Thumb Knobs
- Liner Lock
- Pocket Clip

CK112

SMITH & WESSON® BULLSEYE®

Blade Length
3.4" (8.6 cm)
Overall Length
7.9" (20.1 cm)
Weight
4.2 oz.
UPC
028834702794



7.9"



4.5"

SMITH & WESSON® EXTREME OPS®

Blade Length
2.7" (6.8 cm)
Overall Length
6.4" (16.2 cm)
Weight
2.3 oz.



6.4"



Serrated Blade Option



4.5"

CK113 CLIP POINT BLADE IRIDESCENT HANDLE BOX
UPC - 028834702831

CK113S CLIP POINT SERRATED BLADE IRIDESCENT HANDLE BOX
UPC - 028834702848



SWA24S

SMITH & WESSON® EXTREME OPS®

**7Cr17MoV HIGH CARBON BLACK OXIDE S.S. BLADE
ALUMINUM HANDLE**

- Dual Thumb Knobs
- Liner Lock
- Index Flipper
- Pocket Clip

Blade Length
3.1" (7.9 cm)
Overall Length
7.1" (18.0 cm)
Weight
3.5 oz.



7.1"



4"

SWA24S CLIP POINT SERRATED BLADE BLACK HANDLE BOX
UPC - 028634705436

SWA24SCP CLIP POINT SERRATED BLADE BLACK HANDLE CLAM
UPC - 028634704743

SWA25

SMITH & WESSON® EXTREME OPS®

**7Cr17MoV HIGH CARBON BLACK OXIDE S.S. BLADE
ALUMINUM HANDLE**

- Dual Thumb Knobs
- Liner Lock
- Pocket Clip

Blade Length
3.3" (8.4 cm)
Overall Length
7.8" (19.8 cm)
Weight
3.2 oz.
UPC
028634705443



7.8"



4.5"

CK204CP

SMITH & WESSON® EXTREME OPS®

**7Cr17MoV HIGH CARBON BLACK OXIDE S.S. BLADE
ALUMINUM HANDLE**

- Dual Thumb Knobs
- Liner Lock
- Pocket Clip

Blade Length
3.1" (7.8 cm)
Overall Length
7.7" (19.5 cm)
Weight
4 oz.
UPC
028634708642



7.7"



4.7"

Only Available in Clam Pack



7Cr17MoV HIGH CARBON S.S. BLADE
S.S. HANDLE

- » Dual Thumb Knobs
- » Frame Lock
- » Pocket Clip

CK400

SMITH & WESSON® FOLDING KNIFE

Blade Length
2.2" (5.6 cm)
Overall Length
5.4" (13.8 cm)
Weight
1.6 oz.



5.4"



3.2"

CK400 DROP POINT BLADE STAINLESS STEEL HANDLE BOX

UPC - 028634707027

CK400CP DROP POINT BLADE STAINLESS STEEL HANDLE CLAM

UPC - 028634707164

CK400L

SMITH & WESSON® FOLDING KNIFE

Blade Length
3" (7.6 cm)
Overall Length
7.3" (18.5 cm)
Weight
3.4 oz.



7.3"



Tanto Serrated Blade Option



4.4"

CK400L DROP POINT BLADE STAINLESS STEEL HANDLE BOX

UPC - 028634707157

CK400LCP DROP POINT BLADE STAINLESS STEEL HANDLE CLAM

UPC - 028634707195

CK400LTS TANTO POINT SERRATED BLADE STAINLESS STEEL HANDLE BOX

UPC - 028634708116

CK400LTSCP TANTO POINT SERRATED BLADE STAINLESS STEEL HANDLE CLAM

UPC - 028634708065



CK401

SMITH & WESSON® FOLDING KNIFE

**7Cr17MoV HIGH CARBON BLACK OXIDE S.S. BLADE
S.S. HANDLE**

- Dual Thumb Knobs
- Frame Lock
- Pocket Clip

Blade Length
2.5" (6.3 cm)
Overall Length
5.9" (14.9 cm)
Weight
2.6 oz.
UPC
028634707034



SW423B

SMITH & WESSON® OASIS®

**7Cr17MoV TITANIUM COATED HIGH CARBON S.S. BLADE
TITANIUM COATED S.S. HANDLE**

- Dual Thumb Knobs
- Liner Lock
- Pocket Clip

Blade Length
3.2" (8.1 cm)
Overall Length
7.5" (19.1 cm)
Weight
4.8 oz.



SW423B DROP POINT BLADE TITANIUM BLACK HANDLE BOX
UPC - 028634700783

SW423BS DROP POINT SERRATED BLADE TITANIUM BLACK HANDLE BOX
UPC - 028634701650

Tanto Serrated Blade Option



CK6AEU

SMITH & WESSON® EXTREME OPS®

7Cr17MoV HIGH CARBON S.S. BLADE

ALUMINUM HANDLE

- Nail Groove
- Lockback
- Pocket Clip

Blade Length
3.5" (8.9 cm)
Overall Length
8.1" (20.6 cm)
Weight
3.9 oz.
UPC
020034701865



8.1"



4.6"

SW480BS

SMITH & WESSON® HOMELAND SECURITY®

7Cr17MoV HIGH CARBON BLACK OXIDE S.S. BLADE

ALUMINUM HANDLE

- Nail Groove
- Lockback
- Pocket Clip

Blade Length
3.4" (8.6 cm)
Overall Length
8.1" (20.7 cm)
Weight
3.8 oz.
UPC
028634700301



8.1"



4.8"



CK32C

SMITH & WESSON® EXTREME OPS®

7Cr17MoV HIGH CARBON S.S. BLADE
TITANIUM COATED S.S. HANDLE

- Thumb Hole
- Frame Lock
- Finger Hole
- Pocket Clip

Blade Length
3" (7.6 cm)
Overall Length
8" (20.3 cm)
Weight
4.7 oz.
UPC
028634010394



CK33

SMITH & WESSON® EXTREME OPS®

7Cr17MoV HIGH CARBON S.S. BLADE
G-10 HANDLE

- Dual Thumb Knobs
- Liner Lock
- Finger Hole
- Pocket Clip

Blade Length
3.1" (8.0 cm)
Overall Length
7.9" (19.8 cm)
Weight
6.8 oz.
UPC
028634010486





7Cr17MoV HIGH CARBON S.S. BLADE
S.S. HANDLE

- Dual Thumb Knobs
- Frame Lock

CKLPB

SMITH & WESSON®

Blade Length
2.3" (5.8 cm)
Overall Length
5.3" (13.5 cm)
Weight
1 oz.



5.3"

Actual Size

CKLPB DROP POINT BLADE BLACK HANDLE BOX
UPC - 028634001422

CKLPBCP DROP POINT BLADE BLACK HANDLE CLAM
UPC - 028634001439



3"

CKLPR

SMITH & WESSON®

Blade Length
2.3" (5.8 cm)
Overall Length
5.3" (13.5 cm)
Weight
1 oz.



5.3"

Actual Size

CKLPR DROP POINT BLADE RAINBOW HANDLE BOX
UPC - 028634990689

CKLPRCP DROP POINT BLADE RAINBOW HANDLE CLAM
UPC - 028634990702



3"



7Cr17MoV HIGH CARBON S.S. BLADE
ABS W/RUBBER COATING HANDLE

- Dual Thumb Knobs
- Index Flipper
- Lanyard Hole
- Liner Lock
- Pocket Clip

CKTAC

SMITH & WESSON® SPECIAL TACTICAL®

Blade Length
3.5" (8.9 cm)
Overall Length
8.1" (20.6 cm)
Weight
3.5 oz.



CKTAC TANTO POINT BLADE RUBBER COATED HANDLE BOX
UPC - 028634000753

CKTACSDCP DROP POINT SERRATED BLADE RUBBER COATED HANDLE CLAM
UPC - 028634704477



Drop Point Serrated Blade Option



4.6"

CKTACB

SMITH & WESSON® SPECIAL TACTICAL®

Blade Length
3.5" (8.9 cm)
Overall Length
8.1" (20.6 cm)
Weight
3.5 oz.



Serrated Blade Option



Drop Point Serrated Blade Option



4.6"

CKTACB TANTO POINT BLADE RUBBER COATED HANDLE BOX
UPC - 028634000777

CKTACBS TANTO POINT SERRATED BLADE RUBBER COATED HANDLE BOX
UPC - 028634000784

CKTACBSCP TANTO POINT SERRATED BLADE RUBBER COATED HANDLE CLAM
UPC - 028634700226

CKTACBSD DROP POINT SERRATED BLADE RUBBER COATED HANDLE BOX
UPC - 028634700240

CKTACBSDCP DROP POINT SERRATED BLADE RUBBER COATED HANDLE CLAM
UPC - 028634704385



SW991

NECK KNIFE

8Cr13MoV BLACK OXIDE COATED HIGH CARBON S.S. BLADE
STAINLESS STEEL SKELETON HANDLE

- Full Tang
- Lanyard Hole
- Bottle Opener
- Breakaway Neck Chain
- Nylon Fiber Sheath

Blade Length
2.5" (6.35 cm)
Overall Length
5.5" (13.97 cm)
Weight
1.5 oz.
UPC
028834992294



SW995

KARAMBIT FIXED BLADE

8Cr13MoV STONEWASH HIGH CARBON S.S. BLADE
GLASS FILLED NYLON SLAB HANDLE

- Full Tang
- Lanyard Hole
- Breakaway Neck Chain
- Nylon Fiber Sheath

Blade Length
3.75" (9.53 cm)
Overall Length
8.5" (21.59 cm)
Weight
3.9 oz.
UPC
028834882331





SW993

SMITH & WESSON® FIXED BLADE

8Cr13MoV SATIN FINISH HIGH CARBON S.S. BLADE
GRIVORY MATERIAL HANDLE

- Full Tang
- Lanyard Hole
- Breakaway Neck Chain
- Nylon Fiber Sheath

Blade Length

4" (10.16 cm)

Overall Length

8" (20.32 cm)

Weight

2.3 oz.

UPC

028834992317



SWF5LM

SMITH & WESSON® FIXED BLADE

7Cr17MoV HIGH CARBON S.S. BLADE
MICARTA HANDLE

- Ballistic Sheath w/ Sharpening Stone

Blade Length

6.3" (16.0 cm)

Overall Length

11.1" (28.2 cm)

Weight

11.3 oz.

UPC

028834708588





SWF606

SMITH & WESSON® FIXED BLADE

**8Cr13MoV STONEWASH HIGH CARBON S.S. BLADE
TPE HANDLE**

- Full Tang
- Leather Boot/Belt Sheath

Blade Length
4.4" (11.1 cm)
Overall Length
8.6" (22.0 cm)
Weight
5.8 oz.



SWF606 DAGGER POINT BLADE BLACK HANDLE BOX *No Ship CA, NY, MA*
UPC - 029634709113

SWF606FCP DAGGER POINT FALSE EDGE BLADE BLACK HANDLE CLAM
UPC - 029634709120

SWF606GR

SMITH & WESSON® FIXED BLADE

**8Cr13MoV STONEWASH HIGH CARBON S.S. BLADE
G-10 HANDLE**

- Full Tang
- Leather Boot/Belt Sheath

Blade Length
4.4" (11.1 cm)
Overall Length
8.6" (22.0 cm)
Weight
5.8 oz.
UPC
029634709137



No Ship CA, NY, MA

**SMITH & WESSON® SPECIAL OPS®****9Cr17MoV HIGH CARBON S.S. BLADE
TPE HANDLE**

- Ambidextrous Sheath

Blade Length
5.2" (13.2 cm)
Overall Length
10.6" (26.9 cm)
Weight
8.5 oz.

*Serrated Blade Option***SW7 TANTO POINT BLADE BLACK HANDLE BOX**

UPC - 028634706075

SW7S TANTO POINT SERRATED BLADE BLACK HANDLE BOX

UPC - 028634706099

**SW910****SMITH & WESSON® NECK KNIFE****7Cr17MoV HIGH CARBON S.S. BLADE**

- Full Tang w/550 Paracord Wrapped Handle
- Nylon Fiber Neck Sheath w/Pocket Clip

Blade Length
3.4" (8.6 cm)
Overall Length
7.9" (20.0 cm)
Weight
3.4 oz.
UPC
028634707492

**SW910TAM****SMITH & WESSON® NECK KNIFE****7Cr17MoV HIGH CARBON S.S. BLADE**

- Full Tang w/550 Paracord Wrapped Handle
- Nylon Fiber Neck Sheath w/Breakaway Chain

Blade Length
2.8" (7.1 cm)
Overall Length
5.9" (15.0 cm)
Weight
1.8 oz.

**SW910TAM TANTO POINT BLADE PARACORD WRAPPED HANDLE BOX**

UPC - 028634707737

SW910TAMCP TANTO POINT BLADE PARACORD WRAPPED HANDLE CLAM

UPC - 028634707744



SWHRT3

SMITH & WESSON® H.R.T.®

**7Cr17MoV HIGH CARBON S.S. BLADE
TPR HANDLE**

- Nylon/Fiberglass Sheath

Blade Length
3.5" (8.9 cm)
Overall Length
7.5" (19.1 cm)
Weight
4.6 oz.
UPC
028634882303

No Ship CA, NY, MA



SWHRT3BF

SMITH & WESSON® H.R.T.®

**7Cr17MoV HIGH CARBON BLACK OXIDE S.S. BLADE
TPR HANDLE**

- Nylon/Fiberglass Sheath

Blade Length
3.5" (8.9 cm)
Overall Length
7.5" (19.1 cm)
Weight
4.4 oz.
UPC
028634882310



SWHRT7T

SMITH & WESSON® H.R.T.®

**7Cr17MoV HIGH CARBON BLACK OXIDE S.S. BLADE
TPE HANDLE**

- Leather Sheath

Blade Length
4.7" (12.1 cm)
Overall Length
9" (22.9 cm)
Weight
7.2 oz.
UPC
028634932108





7Cr17MoV HIGH CARBON BLACK OXIDE S.S. BLADE
RUBBERIZED ALUMINUM HANDLE

- Ballistic Sheath w/Sharpening Stone

CKSUR1

SMITH & WESSON® SEARCH & RESCUE®

Blade Length
6" (15.3 cm)
Overall Length
10.5" (26.7 cm)
Weight
7.4 oz.
UPC
028634892655



CKSUR2

SMITH & WESSON® SEARCH & RESCUE®

Blade Length
6" (15.3 cm)
Overall Length
10.5" (26.7 cm)
Weight
7.4 oz.



CKSUR2 BOWIE POINT BLADE BLACK HANDLE BOX
UPC - 028634892682

CKSUR2CP BOWIE POINT BLADE BLACK HANDLE CLAM
UPC - 028634892693

CKSURT

SMITH & WESSON® SEARCH & RESCUE®

Blade Length
6" (15.3 cm)
Overall Length
10.5" (26.7 cm)
Weight
7.9 oz.



CKSURT TANTO POINT BLADE BLACK HANDLE BOX
UPC - 028634892648

CKSURTCP TANTO POINT BLADE BLACK HANDLE CLAM
UPC - 028634892679



SWHRT9B

SMITH & WESSON® H.R.T.®

**7Cr17MoV HIGH CARBON S.S. BLADE
TPE HANDLE**

- Leather Sheath

Blade Length
4.7" (12.1 cm)
Overall Length
9" (22.9 cm)
Weight
7.7 oz.



SWHRT9B DAGGER POINT BLADE BLACK HANDLE BOX No Ship CA, NY, MA
UPC - 028634939208

SWHRT9BCP DAGGER POINT BLADE BLACK HANDLE CLAM No Ship CA, NY, MA
UPC - 028634703458

SWHRT9BF DAGGER POINT FALSE EDGE BLADE BLACK HANDLE BOX
UPC - 028634705450

SWHRT9BFCP DAGGER POINT FALSE EDGE BLADE BLACK HANDLE CLAM
UPC - 028634705047



CKSURC

SMITH & WESSON® HOMELAND SECURITY®

**7Cr17MoV HIGH CARBON S.S. BLADE
G-10 HANDLE**

- Ballistic Sheath w/Sharpening Stone

Blade Length
8.6" (22.0 cm)
Overall Length
13.8" (34.9 cm)
Weight
1 lb. 14.2 oz.
UPC
028634892600





SW3B

SMITH & WESSON® M-9 BAYONET

420J2 BLACK OXIDE STEEL BLADE
NYLON FIBER HANDLE

- Scabbard w/Sharpening Stone

Blade Length
7.8" (19.7 cm)
Overall Length
12.8" (32.6 cm)
Weight
14.6 oz.



SW3B BOWIE POINT BLADE W/NOTCHED SPINE BLACK HANDLE BOX
UPC - 028634700592

SW3BCP BOWIE POINT BLADE W/NOTCHED SPINE BLACK HANDLE CLAM
UPC - 028634706031



SW2E

SMITH & WESSON® M-9 BAYONET

420J2 S.S. BLADE
NYLON FIBER HANDLE

- Scabbard w/Sharpening Stone

Blade Length
7.8" (19.7 cm)
Overall Length
12.8" (32.6 cm)
Weight
14.6 oz.
UPC
028634700608



SW8

SMITH & WESSON® SPEAR

STAINLESS STEEL BLACK OXIDE BLADE
GLASS FILLED NYLON HANDLE

- Screws onto Common Broom Handle Thread
- Nylon Belt Sheath

Blade Length
4.2" (10.7 cm)
Overall Length
10.7" (27.2 cm)
Weight
8.5 oz.
UPC
028634706648





SWTK8CP

SMITH & WESSON® THROWING KNIVES

2Cr13 BLACK OXIDE S.S.

- (3) - 8" Throwing Knives
- Nylon Belt Sheath

Overall Length
8" (20.3 cm)
Overall Weight
12.3 oz.
Individual Weight
4.1 oz.
UPC
028634708963



Only Available in Clear Pack

SWTK8CP

SMITH & WESSON® THROWING KNIVES

2Cr13 S.S.

- (6) - 8" Throwing Knives
- Nylon Belt Sheath

Overall Length
8" (20.3 cm)
Overall Weight
1 lb. 12.2 oz.
Individual Weight
4.7 oz.
UPC
028634708280



Only Available in Clear Pack

SWTK10CP

SMITH & WESSON® THROWING KNIVES

2Cr13 S.S.

- (3) - 10" Throwing Knives
- Nylon Belt Sheath

Overall Length
10" (25.4 cm)
Overall Weight
1 lb. 5.1 oz.
Individual Weight
7 oz.
UPC
028634706297



Only Available in Clear Pack



SW611

SMITH & WESSON® KUKRI

**7Cr17MoV HIGH CARBON BLACK OXIDE S.S. BLADE
RUBBERIZED STEEL HANDLE**

- Full Tang
- Nylon Belt Sheath with Shoulder Strap

Blade Length
11.9" (30.2 cm)
Overall Length
17" (43.2 cm)
Weight
1 lb. 3.8 oz.
UPC
028634990818



SW671

SMITH & WESSON® TOMAHAWK

**1070 HIGH CARBON BLACK OXIDE STEEL BLADE
TPE & STEEL HANDLE**

- Full Tang
- Nylon Sheath

Blade Length
3.9" (9.9 cm)
Overall Length
15.9" (40.4 cm)
Weight
2 lbs. 11 oz.
UPC
028634703432



SWCAMP
SMITH & WESSON® 3 PC. CAMPING SET

Blade Type
3Cr13 S.S.
Handle Material
Rubberized Steel
UPC
028634002016

CK300, CK301 and CH200
(Only Available in SWCAMP Combo)

CK301

Overall 6.6" (16.8 cm)
Weight 2.1 oz.

CH200

Overall 9.5" (24.1 cm)
Weight 8.9 oz.

CH300

Overall 10.7" (27.2 cm)
Weight 12.5 oz.



• CK301



• CH200



• CK300

CH629
SMITH & WESSON® HATCHET/KNIFE COMBO

Blade Type
3Cr13 S.S.
Handle Material
Rubberized Steel
UPC
028634381029

CH100 and CH200
(Only Available in CH629 Combo)

CH100

Overall 10.7" (27.2 cm)
Weight 1 lb. 5.6 oz.

CH200

Overall 9.5" (24.1 cm)
Weight 8.9 oz.

• CH200



• CH100



Nylon Sheath



SWUATI
SMITH & WESSON® UNIVERSAL ARMORER TOOL
INCLUDES:

- 1/16" Allen Wrench
- 1/16" Roll Tip Punch Pin
- 1/8" Roll Tip Punch Pin
- 1/16" Flat Tip Punch Pin
- 1/8" Flat Tip Punch Pin
- M&P® Sleeve Pin
- 1/8" Solid Punch Pin
- 1/8" Brass Flat Tip Punch Pin
- 1/8" Brass Roll Tip Punch Pin
- 1/32" Cut Tip Punch Pin
- 1/16" Cut Tip Punch Pin
- 1/8" Cut Tip Punch Pin



Steel
 Aluminum
 Overall Length
 5.1" (13.0 cm)
 Weight
 2 oz
 UPC
 028634705887

Actual Size



SWMTICP

SMITH & WESSON® MULTI-TOOL

Steel
2Cr13 Stainless Steel
Overall Length
6.5" (16.5 cm)
Weight
8.6 oz.
UPC
028634708877

Only Available in Glam Pack

FUNCTIONS:

- Needle Nose Plier
- Regular Plier
- Wire Cutter
- Fine Edge Blade
- Small Phillips Head
- Can Opener
- Ruler
- Fine Grit File
- Hexagon Wrench (3 Sizes)
- Bottle Opener
- Nail Puller
- Large Screwdriver
- Small Screwdriver
- Saw

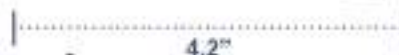

STYLUS
SMITH & WESSON®
T6061 AIRCRAFT ALUMINUM

- » Includes Replacement Stylus Tip
- » Schmidt P900M Parker Style Black Ball Point Pen Refill

 Overall Length
5.4" (13.7 cm)

 Weight
1.6 oz.

Pocket Clip



Glass Breaker



Black



Grey



Pink



Silver

SWPEN3BK TACTICAL STYLUS BLACK PEN BOX
UPC - 028634705498

SWPEN3G TACTICAL STYLUS GREY PEN BOX
UPC - 028634705481

SWPEN3P TACTICAL STYLUS PINK PEN BOX
UPC - 028634705474

SWPEN3S TACTICAL STYLUS SILVER PEN BOX
UPC - 028634705467

SWPEN3SCP TACTICAL STYLUS SILVER PEN CLAM
UPC - 028634705580

SCREW CAP
SMITH & WESSON®
T6061 AIRCRAFT ALUMINUM

- » Screw Cap Pen
- » Schmidt P900M Parker Style Black Ball Point Pen Refill

 Overall Length
5.7" (14.5 cm)

 Weight
1.4 oz.

Pocket Clip



Black



Blue

SWPENBK SCREW CAP BLACK PEN BOX
UPC - 028634702411

SWPENBKCP SCREW CAP BLACK PEN CLAM
UPC - 028634703616

SWPENBL SCREW CAP BLUE PEN BOX
UPC - 028634702428



SWBAT12B

SMITH & WESSON® SMALL COLLAPSIBLE BATON

- Includes Handheld Sheath for Jogging, Walking and Hiking
- Pocket Clip

Steel
 STKM-11A Carbon Steel
 Handle Material
 STKM-11A Carbon Steel
 Handle Length
 5" (12.7 cm)
 Overall Length
 12.1" (30.7 cm)
 Weight
 8.9 oz.



12.1"



Closed



SWBAT12B SMALL COLLAPSIBLE BATON

UPC - 028634705863

SWBAT12BCP SMALL COLLAPSIBLE BATON CLAM PACK

UPC - 028634705870



SWBAT

SMITH & WESSON® COLLAPSIBLE BATON

4130 SEAMLESS ALLOY STEEL TUBING W/HRC 46-47

- Textured and Raised Rubber Handle
- 1680 Denier Outer Shell Belt Sheath (M.D.L.L.E. Compatible)
- Tensile Strength: 6639 lbf (3011 kgf)
- Bending Strength: 4056 lbf (1840 kgf)

SWBAT16H 16" (40.5CM) COLLAPSIBLE BATON BOX
UPC - 028634703012

SWBAT16HCP 16" (40.5CM) COLLAPSIBLE BATON CLAM
UPC - 028634703166

SWBAT21H 21" (53.3CM) COLLAPSIBLE BATON BOX
UPC - 028634703029

SWBAT21HCP 21" (53.3CM) COLLAPSIBLE BATON CLAM
UPC - 028634703173

SWBAT24H 24" (60.9CM) COLLAPSIBLE BATON BOX
UPC - 028634703036

SWBAT24HCP 24" (60.9CM) COLLAPSIBLE BATON CLAM
UPC - 028634703180

SWBAT26H 26" (66.0CM) COLLAPSIBLE BATON BOX
UPC - 028634703043

SWBAT26HCP 26" (66.0CM) COLLAPSIBLE BATON CLAM
UPC - 028634703197



Sheath Comes with All Collapsible Batons



Handle Length 6.6" (16.7 cm) 16"
Weight 13.9 oz.



Handle Length 8.2" (20.8 cm) 21"
Weight 1 lb. 1.1 oz.



Handle Length 9.2" (23.3 cm) 24"
Weight 1 lb. 2.9 oz.



Handle Length 9.7" (24.6 cm) 26"
Weight 1 lb. 3.8 oz.

SWBAT
SMITH & WESSON® COLLAPSIBLE LITE BATON

TIP STEEL 1215MS FREE CUTTING STEEL
FIRST SHAFT STEEL STKM 11A CARBON STEEL
MIDDLE SHAFT MATERIAL 7076 T6 ALUMINUM

- 7076 T6 Aluminum Handle w/Soft Foam Grip
- 1080 Denier Outer Shell Belt Sheath
- Tensile Strength: 2653 lbf (1204 kgf)
- Bending Strength: 1986 lbf (901 kgf)

SWBAT16LT 16" (40.5CM) COLLAPSIBLE LITE BATON BOX
 UPC - 028634709427

SWBAT21LT 21" (53.3CM) COLLAPSIBLE LITE BATON BOX
 UPC - 028634709434

SWBAT24LT 24" (60.9CM) COLLAPSIBLE LITE BATON BOX
 UPC - 028634709441

SWBAT26LT 26" (66.0CM) COLLAPSIBLE LITE BATON BOX
 UPC - 028634709458



Sheath Comes with All Collapsible Batons



M&P



Smith & Wesson®

RETURNING PRODUCTS

#1117281 | DUAL BEAM | 661120081289

NIGHT GUARD® DUAL BEAM HEADLAMP

The Night Guard® Dual Beam Headlamp combines lightweight rugged performance with ultra-bright light output. 425 Lumen output and a secondary red LED make this light perfect for night time use.

ANSI FL1 STANDARD
CERTIFIED



USB
RECHARGEABLE
LITHIUM



REMOVABLE 4-DIRECTION
SHIRT/HAT CLIP



120° ROTATION ALLOWS
FOR DIRECTIONAL LIGHT

FL1 STANDARD	
LUMENS 	425
BATTERY 	2.2 HR
BEAM DISTANCE 	36M
IMPACT RESISTANCE 	RESISTANT
IMPACT RESISTANCE 	1 METER

- ✦ Red & white LEDs
- ✦ USB rechargeable
- ✦ Variable dimming
- ✦ Removable shirt/hat clip
- ✦ Light rotates 120°
- ✦ Heavy duty polymer construction
- ✦ Elastic headband

-
- ✦ BUSTER DIMS: 4.75" w x 7" h x 2" d
 - ✦ CASE PACK: 6
 - ✦ INCLUDES: ELASTIC HEADBAND,
USB CHARGING CORD

Smith & Wesson®

NIGHT GUARD® QUAD BEAM HEADLAMP

#1117282 | QUAD BEAM | 681120081272

The Night Guard® Quad Beam Headlamp combines lightweight rugged performance, ultra-bright light output and multiple colors. 420 Lumen output with secondary red, blue and green LEDs gives you the freedom to use this headlamp in different situations.

ANSI FL1 STANDARD
CERTIFIED

USB
RECHARGEABLE
LITHIUM



REMOVABLE 4-DIRECTION
SHIRT/HAT CLIP

120° ROTATION ALLOWS
FOR DIRECTIONAL LIGHT



Smith & Wesson®

- ✦ Blue, green, red & white LEDs
- ✦ USB rechargeable
- ✦ Variable dimming
- ✦ Removable shirt/hat clip
- ✦ Light rotates 120°
- ✦ Heavy duty polymer construction
- ✦ Elastic headband

- ✦ BUSTER DIMS: 4.75" w x 7" h x 2" d
- ✦ CASE PACK: 6
- ✦ INCLUDES: ELASTIC HEADBAND,
USB CHARGING CORD

FL1 STANDARD	
OUTPUT LUMENS	420
RUNTIME	2.1 HR
BEAM DISTANCE	36M
SHOCK RESISTANCE	RESISTANT
WATER RESISTANCE	1 METER

#1117277 | MICRO | 661120081258



NIGHT GUARD® MICRO FLASHLIGHT

The Night Guard® Micro Flashlight packs a lot of light in a very little package. 120 Lumens output and an almost 3hr. runtime means this light will illuminate through any job.

ANSI FL1 STANDARD
CERTIFIED



- ◆ High output white LED
- ◆ High & Low modes
- ◆ Dual function pocket clip
- ◆ Aerospace aluminum construction
- ◆ Tail cap switch with momentary ON

FL1 STANDARD	
	120
	2.75 HR
	50M
	RESISTANT
	1 METER

- ◆ BLISTER DIMS: 5" w x 9" h x 1" d
- ◆ CASE PACK: 6
- ◆ INCLUDES: 1 AAA BATTERY

Smith & Wesson®

NIGHT GUARD[®] SLIM FLASHLIGHT

#1117278 | SLIM | 661120081241

The Night Guard[®] Slim Flashlight is a very discreet “penlight” style flashlight. Perfect to slip into a breast pocket, this modern styled penlight has 165 Lumen of output and a 5.5hr runtime. The dual function pocket clip allows you to clip it to the brim of a hat or secure it to a pocket.

ANSI FL1 STANDARD
CERTIFIED

TAIL CAP SWITCH



0.6" dia.







5.75" LONG

WHITE HIGH OUTPUT LED

- ✦ High output white LED
- ✦ High & Low modes
- ✦ Dual function pocket clip
- ✦ Aerospace aluminum construction
- ✦ Tail cap switch with momentary ON

- ✦ BLISTER DIMS: 5" w x 9" h x 1" d
- ✦ CASE PACK: 6
- ✦ INCLUDES: 2 AAA BATTERIES

FL1 STANDARD	
	165
	5.5 HR
	55M
	RESISTANT
	1 METER

Smith & Wesson[®]

#1117276 | ELITE | 661120081265

NIGHT GUARD® ELITE FLASHLIGHT

The Night Guard® Elite Flashlight is a perfect utility flashlight. Slim in design, this light packs a large 350 Lumen output. Great for use in a tool box, this light won't take up much space yet can still light up whatever you need. Made of Aerospace Aluminum this light is robust and will last you for years.

ANSI FL1 STANDARD
CERTIFIED







WHITE HIGH OUTPUT LED

TAIL CAP SWITCH

0.85" dia.

6" LONG

FL1 STANDARD	
<small>OUTPUT LUMENS</small> 	350
<small>BEAM DISTANCE</small> 	96M
<small>BEAM DISTANCE</small> 	1.8 HR
<small>IMPACT RESISTANCE</small> 	1 METER
<small>IMPACT RESISTANCE</small> 	RESISTANT

- ◆ High output white LED
- ◆ High & Low modes
- ◆ Pocket clip
- ◆ Aerospace aluminum construction
- ◆ Tail cap switch with momentary ON

- ◆ BLISTER DIMS: 5" w x 10.5" h x 1" d
- ◆ CASE PACK: 6
- ◆ INCLUDES: 2 AA BATTERIES

Smith & Wesson®

NIGHT GUARD[®] DUAL BEAM FLASHLIGHT

#1117279 | DUAL BEAM | 661120081234





The Night Guard[®] Dual Beam Flashlight is a compact Powerhouse with 300 Lumens of bright white light in a flashlight under 5". Made of Aerospace Aluminum with a 1.5hr runtime. Light up the night or preserve your night vision with the red LED.

ANSI FL1 STANDARD
CERTIFIED



- ◆ High output red & white LEDs
- ◆ High & Low modes for both colors
- ◆ Dual function buttons
- ◆ Aerospace aluminum construction

- ◆ BUSTER DIMS: 5" w x 9" h x 2" d
- ◆ CASE PACK: 6
- ◆ INCLUDES: 3 AAA BATTERIES

FL1 STANDARD	
 LUMENS	300
 RUNTIME	1.5 HR
 BEAM DISTANCE	106M
 RESISTANT	RESISTANT
 METER	1 METER

Smith & Wesson[®]





#1117280 | QUAD BEAM | 661120081227

NIGHT GUARD® QUAD BEAM FLASHLIGHT

The Night Guard® Quad Beam Flashlight has 300 Lumen of bright white light plus 3 secondary LED colors: red, green and blue. See in low light conditions, preserve night vision, or signal for awareness. This multi-function light is a perfect choice.

ANSI FL1 STANDARD
CERTIFIED



FL1 STANDARD	
 LUMENS	300
 RUNTIME	1.5 HR
 BEAM DISTANCE	106M
 RESISTANT	RESISTANT
 METER	1 METER

- ◆ High output white, red, green & blue LEDs
- ◆ High & Low modes for white LED
- ◆ High only for red, green & blue LEDs
- ◆ Dual function buttons
- ◆ Aerospace aluminum construction

- ◆ BLISTER DIMS: 5" w x 9" h x 2" d
- ◆ CASE PACK: 6
- ◆ INCLUDES: 3 AAA BATTERIES

Smith & Wesson®

NIGHT GUARD® PRO FLASHLIGHT #1098728

Clam Size: 6.25"W x 9.8"H x 1.6"D Case Pack: 6

- High strength ABS Polymer construction
- Runtime: 2hr 54m high, 16hr 48m low
- Length: 7"
- Head Dia: 1.8"
- 3 light mode settings
- Memory retention remembers last light setting
- Digital ON/OFF switch
- Includes 3 AA batteries



420 LUMENS



LOW-20L, MEDIUM-150L AND HIGH-420L MODES



BEAM DISTANCE



NIGHT GUARD® PRO COMPACT FLASHLIGHT #1099890

Clam Size: 5.5"W x 9"H x 1.5"D Case Pack: 6

- High strength ABS Polymer construction
- Runtime: 3hr 12m high, 8hr 30m low
- Length: 6.1"
- Head Dia: 1.45"
- 3 light mode settings
- Includes 3 AAA batteries



360 LUMENS



LOW-20L, MEDIUM-150L AND HIGH-360L MODES



BEAM DISTANCE



NIGHT GUARD® ELITE DUAL-BEAM FLASHLIGHT #1097656

Claim Size: 5"W x 8.4"H x 1.5"D Case Pack: 6

- Perfect for aviators and pilots
- Runtime White: 3hr 24m High, 43hr Low
- Runtime Red: 7hr 24m high, 72hr 30m low
- Length: 4.8"
- Head Dia: 1.26"
- Weight: 5.4 oz. (with batteries)
- Memory retention remembers last light setting
- Includes 3 AAA batteries
- Anodized aerospace aluminum construction



400 LUMENS

DIAL SMART SWITCHES ALLOW SHUT-OFF WITHOUT CYCLING THROUGH MODES

DIAMOND KNURLED ANODIZED ALUMINUM CONSTRUCTION

COMPACT DESIGN

DUAL LED:
RED - CREE® XPE2 P3
WHITE - CREE® XPG2 S4



LOW-20L AND HIGH-400L MODES FOR WHITE
LOW-2L AND HIGH-50L MODES FOR RED



BEAM DISTANCE



RED LED



NIGHT GUARD® RXP HEADLAMP #1098729

Claim Size: 4.73"W x 6.9"H x 2.4"D Case Pack: 6

- High strength ABS Polymer construction
- USB rechargeable with included cord
- Runtime: 1hr 43m high, 15hr 36m low
- LG 9X LED
- Length: 1.6"
- Width: 1.4"
- Weight: 1.4 oz
- Smooth variable dimming for the perfect amount of light
- Battery: 600mAh Internal rechargeable battery (included)



DIGITAL ON/OFF BUTTON WITH BATTERY INDICATOR LIGHT

300 LUMENS

REMOVABLE 4-DIRECTION HAT/POCKET CLIP



BEAM DISTANCE



SIDE VIEW



USB CHARGING PORT

ADJUSTABLE HEADBAND INCLUDED

SMOOTH VARIABLE DIMMING: LOW-14L – HIGH-300L

store.smith-wesson.com

M&P PISTOL NOVELTY MULTI-TOOL #1094603

Clam Size: 3.875"W x 6.25"H x 0.5"D

Case Pack: 4



- Stainless steel construction
- 13 different tools in a compact design
- Includes aluminum carabiner

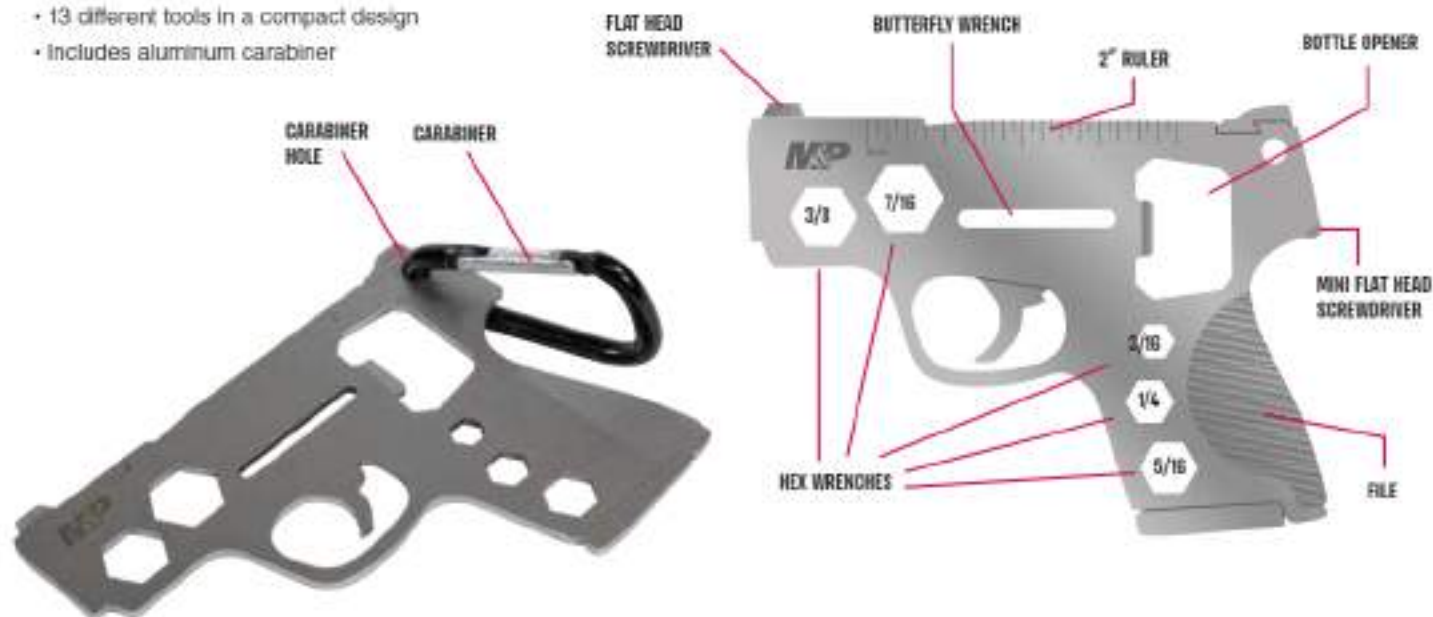

S&W REVOLVER NOVELTY MULTI-TOOL #1095031

Clam Size: 3.875"W x 6.25"H x 0.5"D

Case Pack: 4



- Stainless steel construction
- 7 different tools in a compact design
- Includes aluminum carabiner



OFFICER™: TACTICAL LIGHTS FOR HEAVY-DUTY USE IN ANY LAW ENFORCEMENT OR EXTREME CONDITIONS. BUILT WITH EXTRA DURABLE THICK-WALLED ANODIZED ALUMINUM CONSTRUCTION AND A QUICK CHARGE DESIGN WITH A CHARGING DOCK.

OFFICER™ RXP FLASHLIGHT #1098726

Box Size: 5"W x 9"H x 3"D Case Pack: 6



1025 LUMENS

- Charges automatically when placed into charging station
- Runtime: 2hr 42m high, 18hr 42m low
- Length: 5.8"
- Head Dia: 1.3"
- Weight: 5.6 oz (w. batteries)
- Batteries: one 18650 rechargeable battery (included)
- Crenulated head for self defense
- Anodized aerospace aluminum construction



MECHANICAL RECESSED TAILCAP SWITCH WITH MOMENTARY ON FEATURE

TYPE III HARDCOAT ANODIZED ALUMINUM CONSTRUCTION



CREE® XPL HD V5 LED

QUICKLY AND EASILY RECHARGE FROM THE CHARGING STATION



INCLUDES ADJUSTABLE HOLSTER WITH RETENTION



2 USB CHARGING STATIONS INCLUDED

LOW-125L, HIGH-1025L AND STROBE FUNCTIONS

ADJUSTABLE FLASHLIGHT HOLSTER #1098727

Box Size: 4.8"W x 7.9"H x 2.4"D Case Pack: 6

- Ultra durable Glass-filled nylon construction
- Retention arms firmly hold flashlight in any position, even while running
- Flashlight is quickly removable when needed
- 360° rotation with 26 detent positions
- Quick-release belt clip fits belts up to 2.25" w
- Perfectly designed for M&P® Officer Flashlight and other M&P® Delta Force® MS lights
- Fits Streamlight Strion and other lights with 26-35mm bezels
- Open bottom allows light to be used while still in holster



QUICK-RELEASE BELT CLIP ALLOWS FOR EASY ON AND OFF

RETENTION ARMS FIRMLY HOLD LIGHT BUT ALLOW EASY REMOVAL WHEN NEEDED

CARRY THE LIGHT IN ANY DIRECTION, EVEN UPSIDE DOWN



OPEN BOTTOM ALLOWS LIGHT TO BE USED IN HOLSTER

NIGHT TERROR®: IT'S THE DARK'S TURN TO BE AFRAID.

NIGHT TERROR® COMPACT FLASHLIGHT #1097919

Box Size: 4"W x 9"H x 3"D Case Pack: 4



3230 LUMENS

- USB Rechargeable with included cord
- Runtime: 1hr 35m high, 5hr 18m low
- Length: 6.2"
- Head Dia: 1.76"
- Weight: 7.83 oz (w. batteries)
- Batteries: 1- INR 18650 rechargeable (included)
- 5 light mode settings
- Memory retention remembers last light setting
- Digital ON/OFF switch with lockout feature
- Crenulated head for self defense
- Anodized aerospace aluminum construction



LOW-250L, MEDIUM-1000L, HIGH-3230L, S.O.S. AND STROBE FUNCTIONS

NIGHT TERROR® : IT'S THE DARK'S TURN TO BE AFRAID.

NIGHT TERROR® FLASHLIGHT #1081078

Box Size: 5.1"W x 9"H x 3"D Case Pack: 2



12,500 LUMENS

- Rechargeable with included AC wall and car chargers
- Runtime: 2hr high, 34hr low
- Length: 5.9"
- Head Dia: 2.52"
- Weight: 23 oz (w. batteries)
- Batteries: 4- INR 18650 rechargeable (included)
- 8 light mode settings
- Memory retention remembers last light setting
- Digital ON/OFF switch with lockout feature
- Crenulated head for self defense
- Anodized aerospace aluminum construction

 FL 1 (LOW) 12500 LUMENS (200 low)	 FL 1 (LOW) 2 hrs (34h low)
 FL 1 (LOW) 1m	 FL 1 (LOW) 1m
 FL 1 (LOW) 35.2m BEAM DISTANCE	 FL 1 (LOW) 3075cd PEAK BEAM (CANDELA)

CERTIFIED PERFORMANCE



INCLUDES AC WALL AND CAR CHARGERS

2014 CHEVY SILVERADO

RUNNING LIGHTS ONLY

RUNNING LIGHTS & LOW BEAMS

RUNNING LIGHTS & HIGH BEAMS

NIGHT TERROR™
10x BRIGHTER THAN HIGH BEAMS

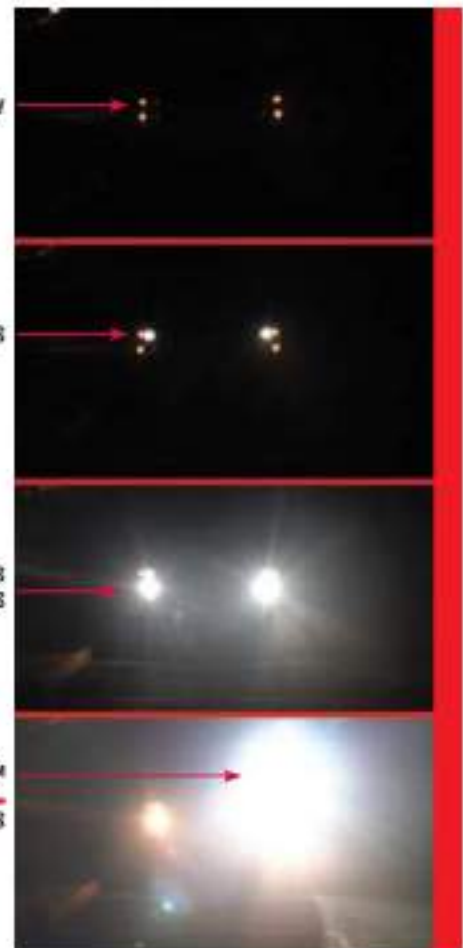

LOW-200L, MEDIUM-LOW-500L, MEDIUM-HIGH-1000L, HIGH-3050L, TURBO 1-6200L, TURBO 2-12500L, S.O.S. AND STROBE MODES

CUSTOMIZABLE AR-15 LOWER PARTS KIT #110115

Clam Size: 3.7"W x 7.2"H x 0.5"D Case Pack: 6

Kit Includes:

- Bolt Catch
- Bolt Catch Plunger
- Bolt Catch Roll Pin
- Bolt Catch Spring
- Buffer Retainer
- Buffer Retainer Spring
- Hammer Pin
- Magazine Catch
- Magazine Catch Button
- Magazine Catch Spring
- Pivot Pin
- Pivot Pin Detent
- Pivot Pin Detent Spring
- Selector
- Selector Detent
- Selector Detent Spring
- Takedown Pin
- Takedown Pin Detent
- Takedown Pin Detent Spring
- Trigger Pin



AR OOPS KIT #1078425

Clam Size: 3.7"W x 4.6"H x 1"D Case Pack: 6

Kit Includes:

- Bolt Catch Plunger
- Bolt Catch Spring
- Bolt Catch Roll Pin
- Buffer Retainer
- Buffer Retainer Spring
- Disconnecter Spring
- Hammer Spring
- Trigger Spring
- Hammer Pin
- Trigger Pin
- Pivot Pin Detent
- Pivot Pin Detent Spring
- Takedown Pin Detent
- Takedown Pin Detent Spring
- Selector Detent
- Selector Detent Spring
- Trigger Guard Roll Pin
- Magazine Catch Spring



COMPLETE AR-15 LOWER PARTS KIT #1085634

Clam Size: 5.4"W x 10.25"H x 1"D Case Pack: 6

The M&P® AR-15 Rifle Complete Lower Parts Kit includes everything needed to build a complete lower receiver. All that is needed is a stripped lower receiver and stock assembly of your choice.

Kit Includes:

- Bolt Catch
- Bolt Catch Plunger
- Bolt Catch Roll Pin
- Bolt Catch Spring
- Buffer Retainer
- Buffer Retainer Spring
- Disconnecter
- Disconnecter Spring
- Hammer
- Hammer Pin
- Hammer Spring
- Magazine Catch
- Magazine Catch Button
- Magazine Catch Spring
- Pistol Grip
- Pistol Grip Lock Washer
- Pistol Grip Screw
- Pivot Pin
- Pivot Pin Detent
- Pivot Pin Detent Spring
- Selector
- Selector Detent
- Selector Detent Spring
- Takedown Pin
- Takedown Pin Detent
- Takedown Pin Detent Spring
- Trigger
- Trigger Guard
- Trigger Guard Roll Pin
- Trigger Pin
- Trigger Spring



COMPLETE AR-15 UPPER PARTS KIT #110116

Clam Size: 3.7"W x 7"H x 0.5"D Case Pack: 6

The M&P® AR-15 Rifle Upper Parts Kit has all the parts you need to finish a stripped upper.

Kit Includes:

- Forward Assist - Assembled
- Forward Assist Spring
- Forward Assist Roll Pin
- Ejection Port Cover
- Ejection Port Spring
- Ejection Port Pin
- Hinge Pin Clip



THUNDERBOLT FULL FRAME SHOOTING GLASSES

Box Size: 4"W x 9.25"H x 3.4"D Case Pack: 6

- ANSI Z87+ certified
- Impact resistant
- UV400 rated
- MIL-PRF 32432 rated
- Full peripheral eye coverage
- Anti-fog lenses
- Hard zippered storage case with microfiber cloth
- Non-reflective matte black frames

Available in black frames with the following lenses:



SUPER COBRA HALF FRAME SHOOTING GLASSES

Box Size: 4"W x 9.25"H x 3.4"D Case Pack: 6

- ANSI Z87+ certified
- Impact resistant
- UV400 rated
- MIL-PRF 32432 rated
- Full peripheral eye coverage
- Anti-fog lenses
- Hard zippered storage case with microfiber cloth
- Non-reflective matte black frames
- Non-slip rubber nose & ear pieces

Available in black frames with the following lenses:



WHITEHAWK FULL FRAME SHOOTING GLASSES

Box Size: 4"W x 9.25"H x 3.4"D Case Pack: 6

- ANSI Z87+ certified
- Impact resistant
- UV400 rated
- MIL-PRF 32432 rated
- Full peripheral eye coverage
- Anti-fog lenses
- Hard zippered storage case with microfiber cloth
- Non-slip rubber nose & ear pieces

Available in white frames with the following lenses:



HARRIER INTERCHANGEABLE HALF FRAME SHOOTING GLASSES #110175

Box Size: 6.7"W x 9.25"H x 2.6"D Case Pack: 6

- ANSI Z87+ certified
- Impact resistant
- UV400 rated
- Full peripheral eye coverage
- Anti-fog lenses
- 4 sets of interchangeable lenses
- "One-touch" lens swaps (no flexing or bending frames to remove lenses)
- Hard zippered storage case with 3 microfiber lens bags
- Non-slip rubber nose & ear pieces

INCLUDES the following lenses:



CORPORAL HALF FRAME SHOOTING GLASSES #110164

Box Size: 4"W x 9.25"H x 2.6"D Case Pack: 6

- ANSI Z87+ certified
- Impact resistant
- UV400 rated
- MIL-PRF 32432 rated
- Full peripheral eye coverage
- Microfiber storage bag
- Non-slip rubber nose piece & ear stems



COLONEL SMALL FRAME SHOOTING GLASSES #110272

Box Size: 4"W x 9.25"H x 2.6"D Case Pack: 6

- ANSI Z87+ certified
- Impact resistant
- UV400 rated
- MIL-PRF 32432 rated
- Full peripheral eye coverage
- Smaller frame for female or youth shooters
- Microfiber storage bag
- Non-slip rubber nose piece and ear stems



MAJOR FULL FRAME SHOOTING GLASSES

Box Size: 4"W x 9.25"H x 2.6"D Case Pack: 6

- ANSI Z87+ certified
- Impact resistant
- UV400 rated
- MIL-PRF 32432 rated
- Full peripheral eye coverage
- Microfiber storage bag
- Non-slip rubber nose piece & ear stems

Available in blue frames with the following lenses:



#110160



#110159



SIGMA ELECTRONIC HEARING PROTECTION #110042

Box Size: 7"W x 6.5"H x 4"D Case Pack: 6



- 20 NRR noise reduction
- Independent volume controls
- Folding compact design
- Fixed padded headband
- Adjustable cushioned ear cups
- ANSI S3.19-1974 Rated
- Amplifies low level sounds
- Compresses high dB noises
- Uses 4 AAA batteries (INCLUDED)

ALPHA ELECTRONIC HEARING PROTECTION #110041

Box Size: 7"W x 6.5"H x 4"D Case Pack: 6



- 23 NRR noise reduction
- Folding compact design
- Padded headband
- LED ON indicator light
- Audio input jack to connect phone or music player
- Adjustable cushioned ear cups
- ANSI S3.19-1974 Rated
- Amplifies low level sounds
- Compresses high dB noises
- Uses 2 AAA batteries (INCLUDED)

SINGLE POINT TACTICAL SLING KIT #110030

Case Size: 5"W x 9.4"H x 2.5"D Case Pack: 6

SLING

- Premium spring-loaded carabiner
- Flexible high-density bungee strap with nylon cover
- Quick-ditch side release buckle
- Fully adjustable
- Ambidextrous for all shooters

AR RECEIVER END PLATE

- Ambidextrous for all shooters
- Accepts snap hook style attachments
- One solid steel plate
- End Plate made in the USA



AR Receiver End Plate

All Smith & Wesson® and M&P® gun cases and bags are designed with quality and durability in mind. Built to hold up under extreme use in harsh conditions, these cases and bags have features such as durable ballistic fabric, heavy-duty hardware, oversized zippers, high quality hook & loop closures and thick nylon strapping.

DEFENDER HANDGUN CASES

1. Small #110018

Size: 9"W x 6"H x 1.5"D Case Pack: 6

2. Medium #110019

Size: 13"W x 7"H x 1.5"D Case Pack: 6

3. Large #110020

Size: 16"W x 9"H x 1.5"D Case Pack: 6

INSIDE:

- Perfect for transporting or storing individual handguns
- Padded walls for protection

OUTSIDE:

- Full-length zipper for easy access



PRO TAC DOUBLE HANDGUN CASE #110029

Size: 15.5"W x 10.5"H x 4"D Case Pack: 6

INSIDE:

- 2 internal padded pistol pockets
- Each pocket fits a revolver with up to an 8" barrel
- Internal pocket dimensions: 14" x 6"

OUTSIDE:

- Double zipper opening of main compartment
- 2 external zippered pockets: 6" W x 6" H x 1" D
- 3 double pistol mag pouches with hook & loop flap closures
- Front, back and bottom padded walls for protection
- Full wrap-around heavy-duty nylon carry straps
- External dimensions: 15.5" W x 10.5" H x 4" D



PRO TAC SINGLE HANDGUN CASE #110028

Size: 14.5"W x 8"H x 3"D Case Pack: 6

INSIDE:

- 1 internal padded pistol pocket
- Fits a revolver with up to a 7" barrel
- Internal pocket dimensions: 14" x 7"

OUTSIDE:

- Double zipper opening of main compartment
- 2 external zippered pockets: 6" W x 6" H x 1" D
- 3 double pistol mag pouches with hook & loop flap closures
- Front, back and bottom padded walls for protection
- Full wrap-around heavy-duty nylon carry straps
- External dimensions: 14.5" W x 8" H x 3" D



All Smith & Wesson[®] and M&P[®] gun cases and bags are designed with quality and durability in mind. Built to hold up under extreme use in harsh conditions, these cases and bags have features such as durable ballistic fabric, heavy-duty hardware, oversized zippers, high quality hook & loop closures and thick nylon strapping.

DUTY SERIES SMALL BACKPACK #110017

Size: 13" W x 18" H x 7" D Case Pack: 6

INSIDE:

- Dual zipper opening
- 11" x 12" elastic laptop pocket
- 2 zippered mesh pockets
- Zippered top pocket
- Internal dimensions: 12" W x 20" H x 5" D

OUTSIDE:

- Made of durable ballistic fabric
- Front zippered external pocket
- Large front pouch: 8" W x 10" H x 2" D
- 2 small accessory clips
- External M.O.L.L.E. webbing
- External dimensions: 13" W x 18" H x 7" D

PRO TAC LARGE BACKPACK #110027

Size: 14" W x 20" H x 12" D Case Pack: 6

INSIDE:

- Dual zipper opening
- 12" x 13" laptop pocket
- Internal zippered pocket
- Zippered mesh pocket
- Internal dimensions: 15" W x 20" H x 5" D

OUTSIDE:

- Made of durable ballistic fabric
- Adjustable waist strap
- 2 zippered accessory pouches
- Side carry strap
- Deep front pouch
- Large front pouch: 9" W x 11" H x 2" D
- External M.O.L.L.E. webbing
- External dimensions: 14" W x 20" H x 12" D

OFFICER TACTICAL RANGE BAG #110023

Size: 22" W x 14" H x 10.5" D Case Pack: 4

OUTSIDE:

- Adjustable 2" wide padded carrying strap with heavy-duty spring clip buckles
- Dual zippered opening for access to the main storage area
- Reinforced wrap-around nylon carrying handles with rubber foot skids on the bottom
- Internal dimensions of main compartment: approx. 18" W x 10" H x 10" D
- External dimensions: 22" W x 14" H x 10.5" D

INSIDE:

- 2 inside full-length accessory pockets
- Includes 2 padded, zippered single handgun cases: 13.5" x 9.5"
- Internal padded ammo bag with 2 zippered side pockets
 - 2 adjustable hook and loop dividing walls
 - 2 sets of vertical accessory pouches
- Clip-on nylon brass holder with cinch down closure

RECRUIT TACTICAL RANGE BAG #110013

Size: 17" W x 10" H x 10" D Case Pack: 4

OUTSIDE:

- Adjustable 2" wide padded carrying strap with heavy-duty spring clip buckles
- Dual zippered opening gives ample room
- Reinforced wrap-around nylon carrying handles with rubber foot skids on the bottom
- External dimensions: 17" W x 10" H x 10" D

INSIDE:

- 2 inside full-length accessory pockets
- Internal dimensions of main compartment: approx. 15" W x 8" H x 8" D



PRO TAC 3 AR/AK MAGAZINE POUCH #110267

Clam Size: 9.8"W x 10"H x 1"D Case Pack: 6

- 3 AR/AK magazine pouches
- Will accept 1 AK or 2 AR, 30rd magazines per pouch
- Made of durable ballistic fabric
- 3 fold-over flaps with hook & loop closures
- Outside of 1 flap has loop backing to attach custom patches
- Double stitch reinforcement
- Backside has 4 M.O.L.L.E. snap attachments
- External dimensions: approx. 11.125" W x 7.75" H x 3" D



All Smith & Wesson[®] and M&P[®] gun cases and bags are designed with quality and durability in mind. Built to hold up under extreme use in harsh conditions, these cases and bags have features such as: durable ballistic fabric, heavy-duty hardware, oversized zippers, high quality hook & loop closures and thick nylon strapping.

DUTY SERIES GUN CASES

Case Pack: 6

OUTSIDE:

- Multiple AR mag pouches
- Made of durable ballistic fabric
- Full-length zipper
- Adjustable nylon shoulder strap
- Heavy-duty carry handles
- Zippered external pocket
- External center open pocket



PRO TAC GUN CASES

Case Pack: 4

OUTSIDE:

- Full-length 2" wide adjustable, padded shoulder strap
- Full-length double zipper opening
- 31" L x 13" H x 1.5" D full flap zippered external pouch
- Made of durable ballistic fabric

INSIDE:

- 2 rows of M.O.L.L.E. strapping with 4 hook & loop interchangeable straps
- Front, back and bottom padded walls for semi rigid protection



DELTA OPS MULTI-GUN CASE

Case Pack: 4

INSIDE:

- Internal dimensions: 46" L x 10.6" H x 3" D
- 2 full-length gun slots with removable padded center divider
- Removable 3-point padded adjustable shoulder strap harness
- 2 dual-side release buckles on the straps allow for quick ditch
- 2" wide nylon shoulder strap with movable shoulder pad

OUTSIDE:

- Made of durable ballistic fabric
- Heavy-duty hardware
- Full-length dual zipper closure with full length fold over flap with snap closure
- Heavy-duty drag strap
- 2 long external padded pouches with internal straps and dual side release buckles
- 10 single M.O.L.L.E. straps on one side with an additional 18, 1" wide nylon loops for added customization



ID	Product #	Model	Description	Gun Length	# of Pockets	External Dims
A	1074567	DUTY SERIES	29" Gun Case	28"	3 Magazine	29.5" L x 12.5" H x 2" D
B	110014	DUTY SERIES	Small Case	34"	3 Magazine	35.5" L x 12" H x 2" D
C	110015	DUTY SERIES	Medium Case	40"	4 Magazine	41.5" L x 12" H x 2" D
D	110016	DUTY SERIES	Large Case	45"	5 Magazine	46.5" L x 12" H x 2" D
E	110024	PRO TAC	36" Long Gun Case	36"	6 Magazine	36" L x 13" H x 3" D
F	110025	PRO TAC	42" Long Gun Case	42"	6 Magazine	42" L x 13" H x 3" D
G	110026	PRO TAC	48" Long Gun Case	48"	6 Magazine	48" L x 13" H x 3" D
H	110047	DELTA OPS	Multi-Gun Case	45"	3 Accessory	48" L x 12" H x 4.5" D

COMPACT RIFLE CLEANING KIT #1084758

Box Size: 3.3"W x 8.3"H x 2.2"D Case Pack: 6

- Semi-rigid carry case fits into an AR magazine pouch
- For use on .22 or .30 caliber rifles

Kit Includes:

- AR chamber brush
- Multi-function bolt scraper tool
- Cleaning pick
- Nylon cleaning brush
- Collapsible 36" stainless steel cleaning rod with rotating T-handle
- 3 Star Chamber cleaning pads
- Patches for .22 or .30 cal
- Nylon brushes for .22 or .30 cal
- Jags for .22 or .30 cal
- Slotted tip



COMPACT HANDGUN CLEANING KIT #110176

Box Size: 5.1"W x 9.3"H x 3.8"D Case Pack: 6

- For use on pistol calibers ranging from .22 - .45 (.22, 9mm/.357/.38, .40/.10mm, .44-.45 calibers)
- Collapsible cleaning rod with rotating T-handle
- Stainless steel cleaning rod

Kit Includes:

- Cleaning pick
- Nylon cleaning brush
- Pistol brushes for .22 - .45 cal
- Jags for .22 - .45 cal
- Slotted tips



RIFLE FIELD CLEANING KIT #1082194

Bag Size: 2.8"W x 7"H x .6"D Case Pack: 10

- Coated steel cable construction utilizes felt plugs for cleaning rifle calibers ranging from .22 - .338
 - Nylon brush with pick for stubborn fouling
 - Lint-free cloth for wiping down firearms
 - Pre-saturated oil wipe for metal protection
 - Grease packet for lubrication of high-wear areas
 - Resealable package
 - Disposable gloves
 - Lens cleaning cloth for optics
- Kit Includes:
- 18 felt plugs (3 in each caliber size)
 - .22
 - .6mm/.243
 - .25-.264
 - .277-.284
 - .30
 - 8mm-.338



HANDGUN FIELD CLEANING KIT #1082193

Bag Size: 2.8"W x 7"H x .6"D Case Pack: 10

- Designed for .380/9mm, .40, and .45 calibers
- Large cotton swab for cleaning barrels, chambers and cylinders
- Nylon brush with pick for stubborn fouling
- Lint-free cloth for wiping down firearms
- Pre-saturated oil wipes for metal protection
- Resealable package
- Disposable gloves
- Grease packet



DELTA FORCE®: THE ULTIMATE IN TACTICAL LIGHTING DESIGN WITH EXTRA DURABLE THICK-WALLED ANODIZED ALUMINUM CONSTRUCTION FOR HEAVY-DUTY USE IN EXTREME CONDITIONS.

DELTA FORCE® CS 1XAAA #1078454

Clam Size: 5.5"W x 8.6"H x 3"D Case Pack: 6



125 LUMENS HIGH

10 LUMENS LOW



- CREE® XPG2 LED
- Length: 4.0"
- Head diameter: 0.70"
- Weight: 1.41 oz (w. battery)
- Batteries: 1-AAA batteries (INCLUDED)
- High, low, strobe and momentary-ON functions
- Memory retention remembers last light setting
- Constructed from anodized aerospace aluminum
- Tail cap ON/OFF switch
- Dual-function spring steel clip
- Crenulated head for self defense

DELTA FORCE® CS 1XAA #110146

Clam Size: 5.9"W x 7.3"H x 3.1"D Case Pack: 6



130 LUMENS HIGH

20 LUMENS LOW



- CREE® XBH LED
- Length: 4"
- Head diameter: 0.81"
- Weight: 2.05 oz (w. batteries)
- Batteries: 1-AA battery (INCLUDED)
- High, low, strobe and momentary-ON functions
- Memory retention remembers last light setting
- Constructed from anodized aerospace aluminum
- ON/OFF tail cap switch
- Dual-function spring steel clip attaches to pocket, belt or hat bill
- Crenulated head for self defense

DELTA FORCE® CS RXP INTEGRAL BATTERY #1078449

Clam Size: 5"W x 10.5"H x 1.5"D Case Pack: 6



310 LUMENS HIGH

20 LUMENS LOW



- CREE® XPG2 LED
- Length: 3.46"
- Head diameter: 0.26"
- Weight: 1.13 oz (w. battery)
- Batteries: 1 integrated Lithium ION battery (INCLUDED)
- Low, medium and high functions
- Memory retention remembers last light setting
- Constructed from anodized aerospace aluminum
- Twist ON/OFF switch
- Dual-function spring steel clip
- Crenulated head for self defense
- Includes USB to Micro USB charging cord



DELTA FORCE® CS 1XCR123 #110147

Clam Size: 4.4"W x 6.5"H x 2"D Case Pack: 6



215 LUMENS HIGH

25 LUMENS LOW



- CREE® XPG2 LED
- Length: 3.5"
- Head diameter: 0.81"
- Weight: 2.54 oz (w. battery)
- Batteries: 1-CR123 battery (INCLUDED)
- High, low, strobe and momentary-ON functions
- Memory retention remembers last light setting
- Constructed from anodized aerospace aluminum
- ON/OFF tail cap switch
- Dual-function spring steel clip
- Crenulated head for self defense

DELTA FORCE® CS 2XAAA #1078455

Clam Size: 4.7"W x 3.4"H x 1"D Case Pack: 6

175 LUMENS HIGH

10 LUMENS LOW



- CREE® XPG2 LED
- Length: 5.83"
- Head diameter: 0.70"
- Weight: 2.12 oz (w. batteries)
- Batteries: 2-AAA batteries (INCLUDED)
- High, low, strobe and momentary-ON function
- Memory retention remembers last light setting
- Constructed from anodized aerospace aluminum
- Tail cap ON/OFF switch
- Spring steel clip
- Crenulated head for self defense



DELTA FORCE® CS 2XCR123 #1078458

Clam Size: 4.6"W x 7.3"H x 2"D Case Pack: 6

490 LUMENS HIGH

30 LUMENS LOW



- CREE® XPG2 LED
- Length: 4.9"
- Head diameter: 0.95"
- Weight: 2.82 oz (w. batteries)
- Batteries: 2- CR123 batteries (INCLUDED)
- High, low, strobe and momentary-ON functions
- Memory retention remembers last light setting
- Constructed from anodized aerospace aluminum
- Tail cap ON/OFF switch
- Spring steel clip
- Crenulated head for self defense



DELTA FORCE® MS 2XAA #1078456

Clam Size: 5.1"W x 9.1"H x 2"D Case Pack: 6

380 LUMENS HIGH

40 LUMENS LOW



- CREE® XPG2 LED
- Length: 6.34"
- Head diameter: 1.1"
- Weight: 5.78 oz (w. batteries)
- Batteries: 2-AA batteries (INCLUDED)
- High, low, strobe and momentary-ON functions
- Memory retention remembers last light setting
- Constructed from anodized aerospace aluminum
- Tail cap ON/OFF switch
- Crenulated head for self defense



DELTA FORCE® KL RXP 16340 #1074565

Clam Size: 3"W x 6"H x 1.2"D Case Pack: 6

200 LUMENS HIGH

30 LUMENS LOW



- CREE® XP-E2 LED
- Length: 2.55"
- Head diameter: 0.82"
- Weight: 1.45 oz (w. battery)
- Batteries: 1-RCR123A rechargeable battery (INCLUDED)
- Low, medium, high and strobe functions
- Memory retention remembers last light setting
- Constructed from anodized aerospace aluminum
- Twist ON/OFF switch
- Crenulated head for self defense
- Includes key chain split ring
- Includes USB to Micro USB charging cord



DELTA FORCE®: THE ULTIMATE IN TACTICAL LIGHTING DESIGN WITH EXTRA DURABLE THICK-WALLED ANODIZED ALUMINUM CONSTRUCTION FOR HEAVY-DUTY USE IN EXTREME CONDITIONS.

DELTA FORCE® MS 2XCR123 #1078457

Clam Size: 4.9"W x 7.2"H x 2"D Case Pack: 6



1050 LUMENS HIGH
35 LUMENS LOW



- CREE® XPL LED
- Length: 5.4"
- Head diameter: 1.4"
- Weight: 5.88 oz (w. batteries)
- Batteries: 2 - CR123 batteries (INCLUDED)
- High, low, strobe and momentary-ON functions
- Memory retention remembers last light setting
- Constructed from anodized aerospace aluminum
- Tail cap ON/OFF switch
- Crenulated head for self defense
- Weapon-mountable using 1" ring



DELTA FORCE® MS RXP 18650 #1081076

Clam Size: 4.9"W x 6"H x 2"D Case Pack: 6



1050 LUMENS HIGH
100 LUMENS LOW



- CREE® XPL LED
- Length: 5.9"
- Head diameter: 1.57"
- Weight: 7.41 oz (w. battery)
- Batteries: 1 - 18650 rechargeable battery (INCLUDED)
- Low, high, strobe and momentary-ON functions
- Memory retention remembers last light setting
- Constructed from anodized aerospace aluminum
- Tail cap ON/OFF switch
- Crenulated head for self defense
- Lanyard carry strap (INCLUDED)
- Includes USB to Micro USB charging cord



DELTA FORCE® MS 3XCR123 #110148

Clam Size: 5.4"W x 9.5"H x 3"D Case Pack: 6



1115 LUMENS HIGH
75 LUMENS LOW



- CREE® XML2-U2 LED
- Length: 6.93"
- Head diameter: 1.7"
- Weight: 8.6 oz (w. batteries)
- Batteries: 3 - CR123 batteries (INCLUDED)
- High, low, strobe and momentary-ON modes
- Memory retention remembers last light setting
- Constructed from anodized aerospace aluminum
- ON/OFF tail cap switch
- Crenulated head for self defense



DELTA FORCE® FS 4XCR123 #110046

Clam Size: 5.5"W x 13"H x 2.3"D Case Pack: 6



2100 LUMENS HIGH
50 LUMENS LOW



- CREE® XHP 50 LED
- Length: 9.3"
- Head diameter: 2.4"
- Weight: 13.2 oz (w. batteries)
- Batteries: 4 - CR123 batteries (INCLUDED)
- High, low, strobe and momentary-ON modes
- Memory retention remembers last light setting
- Constructed from anodized aerospace aluminum
- Tail cap ON/OFF switch
- Rubberized grip for a sure grip and easy handling
- Crenulated head for self defense



DELTA FORCE®: THE ULTIMATE IN TACTICAL LIGHTING DESIGN WITH EXTRA DURABLE THICK-WALLED ANODIZED ALUMINUM CONSTRUCTION FOR HEAVY-DUTY USE IN EXTREME CONDITIONS.

DELTA FORCE® RM 2XCR123 #1083419

WITH M-LOK® AND KEYMOD ADAPTERS

Clam Size: 5"W x 8"H x 2"D Case Pack: 6

900 LUMENS HIGH

90 LUMENS LOW



- CREE® XPL LED
- Length: 5.31"
- Head diameter: 1.26"
- Weight: 4.94 oz (w. batteries)
- Batteries: 2 - CR123 batteries (INCLUDED)
- High, low, strobe and momentary-ON functions
- Memory retention remembers last light setting
- Includes an M-LOK® mount with KeyMod adapter and remote ON/OFF button with cord
- Remote button includes hook & loop mounting straps
- Constructed from anodized aerospace aluminum
- Tail cap with momentary and ON/OFF switch
- Crenulated head for self defense



STROBE WEAPON MOUNTABLE

DELTA FORCE® RM 1XCR123 #1083420

WITH M-LOK® AND KEYMOD ADAPTERS

Clam Size: 5"W x 8"H x 2"D Case Pack: 6

500 LUMENS HIGH

50 LUMENS LOW



- CREE® XPL LED
- Length: 4"
- Head diameter: 1.26"
- Weight: 3.9 oz (w. batteries)
- Batteries: 1 - CR123 battery (INCLUDED)
- High, low, strobe and momentary-ON functions
- Memory retention remembers last light setting
- Includes an M-LOK® mount with KeyMod adapter and Remote ON/OFF button with cord
- Remote button includes hook & loop mounting straps
- Constructed from anodized aerospace aluminum
- Tail cap with momentary and ON/OFF switch
- Crenulated head for self defense



STROBE WEAPON MOUNTABLE

DELTA FORCE® RM 1XCR123 PIC RAIL #110043

Clam Size: 5"W x 8"H x 2"D Case Pack: 6

500 LUMENS HIGH

50 LUMENS LOW



- CREE® XPL LED
- Length: 4"
- Head diameter: 1.26"
- Weight: 3.9 oz (w. battery)
- Batteries: 1 - CR123 battery (INCLUDED)
- High, low, strobe and momentary-ON functions
- Memory retention remembers last light setting
- Includes a Pic Rail Mount and remote ON/OFF button with cord
- Remote button includes hook & loop mounting straps
- Constructed from anodized aerospace aluminum
- Tail cap with momentary ON/OFF switch
- Crenulated head for self defense



STROBE WEAPON MOUNTABLE

DELTA FORCE® RM 2XCR123 PIC RAIL #110044

Clam Size: 5"W x 8"H x 2"D Case Pack: 6

900 LUMENS HIGH

90 LUMENS LOW



- CREE® XPL LED
- Length: 5.31"
- Head diameter: 1.26"
- Weight: 4.94 oz (w. batteries)
- Batteries: 2 - CR123 batteries (INCLUDED)
- High, low, strobe and momentary-ON functions
- Memory retention remembers last light setting
- Includes a Pic Rail Mount and remote ON/OFF button with cord
- Remote button includes hook & loop mounting straps
- Constructed from anodized aerospace aluminum
- Tail cap with momentary ON/OFF switch
- Crenulated head for self defense



STROBE WEAPON MOUNTABLE

DUTY SERIES: ULTRA-BRIGHT, RECHARGEABLE POWER FLASHLIGHTS READY FOR ANY EMERGENCY.

DUTY SERIES CS RXP 1X18350 #1078450

Clam Size: 4.5"W x 6.9"H x 2"D Case Pack: 6



970 LUMENS HIGH

85 LUMENS LOW



- CREE® XPL LED
- Length: 3"
- Head diameter: 1"
- Weight: 2.54 oz (w. battery)
- Batteries: 1- 18350 Rechargeable battery (INCLUDED)
- Low, medium, high, turbo and S.O.S. functions
- Memory retention remembers last light setting
- Constructed from anodized aerospace aluminum
- Digital ON/OFF switch with lockout feature
- Dual-function spring steel clip
- Crenulated head for self defense
- Includes USB to Micro USB charging cord



DUTY SERIES CS RXP 1X18650 #1078451

Clam Size: 4.4"W x 4.6"H x 2"D Case Pack: 6



1038 LUMENS HIGH

90 LUMENS LOW



- CREE® XPL LED
- Length: 4.65"
- Head diameter: 1.25"
- Weight: 3.32 oz (w. batteries)
- Batteries: 1- 18650 rechargeable battery (INCLUDED)
- Low, medium, high, turbo and S.O.S. functions
- Memory retention remembers last light setting
- Constructed from anodized aerospace aluminum
- Digital ON/OFF switch with lockout feature
- Dual-function spring steel clip
- Crenulated head for self defense
- Includes USB to Micro USB charging cord



DUTY SERIES MS RXP 1X18650 BATTERY BANK #1074566

Clam Size: 3.6"W x 3.0"H x 2"D Case Pack: 6

1045 LUMENS HIGH

85 LUMENS LOW



- CREE® XPL LED
- Length: 6"
- Head diameter: 1.81"
- Weight: 8.25 oz (w. battery)
- Batteries: 1- 18650 rechargeable battery (INCLUDED)
- Internal 3400mAh battery bank can charge cell phones, lights or other accessories
- Low, medium, high, turbo and S.O.S. functions
- Memory retention remembers last light setting
- Constructed from anodized aerospace aluminum
- Digital ON/OFF switch with lockout feature
- Crenulated head for self defense
- Includes USB to Micro USB charging cord



NIGHT TERROR™ SLIM #1081077

Box Size: 4.1"W x 12.8"H x 3"D Case Pack: 6



3,100 LUMENS HIGH

250 LUMENS LOW



- CREE® XHP 70.2 LED
- Length: 9.65"
- Head diameter: 2.2"
- Weight: 17.54 oz (w. batteries)
- Batteries: 2- 18650 rechargeable batteries (INCLUDED)
- Tripod mountable
- Low, medium, high, and turbo strobe and momentary-ON functions
- Constructed from anodized aerospace aluminum
- Digital ON/OFF switch with LOCK OUT feature
- Crenulated head for self defense
- Rubber textured grip
- Includes USB to Micro USB charging cord



DELTA FORCE®: THE ULTIMATE IN TACTICAL LIGHTING DESIGN WITH EXTRA DURABLE THICK-WALLED ANODIZED ALUMINUM CONSTRUCTION FOR HEAVY-DUTY USE IN EXTREME CONDITIONS.

DELTA FORCE® HL 3XAAA HEADLAMP #110152

Clam Size: 4.2"W x 4.6"H x 2.4"D Case Pack: 6



430 LUMENS TURBO-HIGH

65 LUMENS LOW



- CREE® XP-G2 R5 LED
- Weight: 3.11 oz (w. batteries)
- Batteries: 3-AAA batteries (INCLUDED)
- Lightweight, comfortable design
- Low, medium, high, turbo-high, strobe and S.O.S. modes
- Constructed from anodized aerospace aluminum
- One-button control switch for one-handed use
- Fully adjustable headband



DELTA FORCE® HL RXP 1X18650 HEADLAMP #110153

Clam Size: 5.9"W x 7.4"H x 2.6"D Case Pack: 6



870 LUMENS HIGH

45 LUMENS LOW



- CREE® XML2 LED
- Weight: 3.11 oz (w. battery)
- Batteries: 1-rechargeable 18650 Li-ION (INCLUDED)
- Lightweight, comfortable design
- Rechargeable
- Low, medium, high, turbo, strobe and S.O.S. modes
- Constructed from anodized aerospace aluminum
- One button control switch for one-handed use
- Fully adjustable head band



NIGHT TERROR® HEADLAMP #1117195

Hanging Box: Case Pack: 4



430 LUMENS TURBO-HIGH

65 LUMENS LOW

- 2000 Lumen LED
- USB rechargeable
- Batteries: 1 Rechargeable Li-ION (INCLUDED)
- Lightweight, comfortable design
- Low, medium, high, ultra-high, strobe and S.O.S. modes
- Constructed from anodized aerospace aluminum
- Illuminated power indicator
- 180° light rotation on headband
- Fully adjustable headband
- Includes charging cord and elastic headband

Illuminated battery indicator



180° rotation



DELTA FORCE®: THE ULTIMATE IN TACTICAL LIGHTING DESIGN WITH EXTRA DURABLE THICK-WALLED ANODIZED ALUMINUM CONSTRUCTION FOR HEAVY-DUTY USE IN EXTREME CONDITIONS.

DELTA FORCE® PL-10 PENLIGHT #110155

Clam Size: 3.8"W x 9.5"H x 1"D Case Pack: 6

105 LUMENS



REAL WRITING
PEN POINT

- CREE® XPE2 LED
- Length: 6.1"
- Diameter: 0.57"
- Weight: 1.17 oz (w. battery)
- Batteries: 1 AAA battery (INCLUDED)
- Lightweight, comfortable design
- Pen uses Zebra refillable inserts
- Self defense tip with DNA retention features
- Constructed from anodized aerospace aluminum
- Twist ON/OFF light
- Spring steel clip



DELTA FORCE® PL 1XAAA LASER PENLIGHT #1078448

Clam Size: 5"W x 9.5"H x 1"D Case Pack: 6

130 LUMENS HIGH



REAL WRITING
PEN POINT



RED LASER

- CREE® XPG2 LED
- Length: 6.5"
- Head diameter: 0.6"
- Weight: 1.62 oz (w. battery)
- Batteries: 1- AAA battery (INCLUDED)
- Laser pointer function
- Constructed from anodized aerospace aluminum
- Twist ON/OFF/Laser pointer/flashlight
- Spring steel clip
- Includes 1 Schmidt P900 Black Ink insert



SELF DEFENSE TACTICAL PENLIGHT #110250

Clam Size: 3.7"W x 9.5"H x 1"D Case Pack: 12



- Runtime: 30+hrs
- Beam distance: 11m
- Length: 5.85"
- Weight: 1.7 oz (w. batteries)
- Batteries: 2-AAA (INCLUDED)
- Water resistant
- Impact resistant
- Aerospace aluminum
- Diamond cut knurling
- Silent twist ON/OFF
- Includes batteries and integrated pocket clip



GALAXY® 6 LED #110242

Clam Size: 6"W x 8.6"H x 2"D Case Pack: 6



12 LUMENS WHITE

3 WHITE / 3 RED LEDS



PATENTED
WWW.SMITHSWESSON.COM/PATENTS

Ratings for white beam:

- Runtime: 8hrs
- Beam distance: 8.2m
- Length: 7"
- Weight: 6.1 oz (w. batteries)
- Batteries: 2-AA batteries (INCLUDED)
- Waterproof
- Impact resistant
- Anodized aerospace aluminum
- Patented dual-switch system for easy selection
- Includes holster and lanyard



WHITE LED



RED LED

GALAXY® 28 LED #110230

Clam Size: 5.7"W x 8.3"H x 2.3"D Case Pack: 6



42 LUMENS WHITE

20 WHITE / 4 RED / 4 BLUE LEDS



PATENTED
WWW.SMITHSWESSON.COM/PATENTS

Ratings for white beam:

- Runtime: 19hrs 48min
- Beam distance: 32m
- Length: 6.5"
- Weight: 8 oz (w. batteries)
- Batteries: 3-AAA batteries (INCLUDED)
- Waterproof
- Impact resistant
- Anodized aerospace aluminum
- Diamond cut knurling
- Patented dual-switch system for selection of white or colored LEDs
- Includes batteries, holster and lanyard



WHITE LED



RED LED



BLUE LED

GALAXY® 13 LED #110226

Clam Size: 6.25"W x 9.5"H x 3.25"D Case Pack: 6



19 LUMENS WHITE

10 WHITE / 3 RED LEDS



PATENTED
WWW.SMITHSWESSON.COM/PATENTS

Ratings for white beam:

- Runtime: 26hrs 30min
- Beam distance: 17m
- Length: 6.5"
- Weight: 7.7 oz (w. batteries)
- Batteries: 3-AAA batteries (INCLUDED)
- Waterproof
- Impact resistant
- Anodized aerospace aluminum
- Diamond cut knurling
- Patented dual-switch system for selection of white or colored LEDs
- Includes holster and lanyard



WHITE LED



RED LED

GALAXY® 12 LED #110224

Clam Size: 5.3"W x 9"H x 3.5"D Case Pack: 3



15 LUMENS WHITE

6 WHITE / 2 RED / 2 BLUE / 2 GREEN LEDS



PATENTED
WWW.SMITHSWESSON.COM/PATENTS

Ratings for white beam:

- Runtime: 3hrs 30mins
- Beam distance: 12m
- Length: 6.25"
- Weight: 7.6 oz (w. batteries)
- Batteries: 3-AAA batteries (INCLUDED)
- Waterproof
- Impact resistant
- Anodized aerospace aluminum
- Diamond cut knurling
- Patented dual-switch system for selection of white or colored LEDs
- Includes holster and lanyard



WHITE LED



RED LED



BLUE LED



GREEN LED

GALAXY®: YOUR ESSENTIAL LIGHTING FOR EVERY-DAY USE.

GALAXY® ELITE #110253

Clam Size: 5.6"W x 7.4"H x 1"D Case Pack: 6



365 LUMENS



- Runtime: 4hrs 15m
- Length: 6"
- Weight: 6.3 oz (w. batteries)
- Batteries: 2-AA batteries (INCLUDED)
- Anodized aerospace aluminum
- Diamond cut knurling
- Silent twist ON/OFF tail cap with momentary button
- Includes holster and lanyard
- Crengulated for self defense



GALAXY® 9 LED #110204

Clam Size: 5.4"W x 6.1"H x 1.5"D Case Pack: 12



- Runtime: 60hrs
- Beam distance: 15m
- Length: 4.5"
- Weight: 4.1 oz (w. batteries)
- Batteries: 3-AAA batteries (INCLUDED)
- Waterproof
- Impact resistant
- Anodized aerospace aluminum
- Diamond cut knurling
- ON/OFF tail cap switch
- Includes lanyard

GALAXY® GREEN BEAM #110252

Clam Size: 6"W x 11"H x 3.9"D Case Pack: 6



94 LUMENS GREEN

5 LUMENS RED



Ratings for green beam:

- Runtime: 39hrs
- Length: 7.25"
- Weight: 7.7 oz (w. batteries)
- Batteries: 3-AAA batteries (INCLUDED)
- Powerful green CREE® LED for long range and red LED for low light use
- Tactical tail cap ON/OFF switch for green LED and separate switch on barrel for red LED
- Anodized aerospace aluminum
- Includes lanyard and holster



GALAXY® MICRO RAY #1074564

Clam Size: 5"W x 6"H x 1.5"D Case Pack: 6



- Length: 1.62"
- Head diameter: 0.44"
- Weight: 0.25 oz (w. batteries)
- Batteries: 4-L736F batteries (INCLUDED)
- Constructed from anodized aerospace aluminum
- Twist ON/OFF switch
- Impact resistant
- Waterproof
- Includes key chain split ring

GALAXY® RAY BLACK #110198

Clam Size: 5"W x 6"H x 1.5"D Case Pack: 12



- Runtime: 30+hrs
- Beam distance: 6m
- Length: 2.25"
- Weight: 1 oz (w. batteries)
- Batteries: 4-LR44 (INCLUDED)
- Water resistant
- Impact resistant
- Anodized aerospace aluminum
- Diamond cut knurling
- Push-button ON/OFF tail cap switch
- Aluminum spring clip key chain clip

A collection of knives and sharpening tools is arranged on a light-colored wooden surface. In the foreground, a large knife with a black handle and a silver blade is prominent. Behind it, a smaller knife with a yellow handle and a silver blade is visible. To the right, a white sharpening stone with a black top layer is shown, with the brand name 'Made in Germany' visible on its side. The background is a dark, textured surface.

ACCESSORIES

SHARPENERS // SHEATHS // PROMO ITEMS // DISPLAYS

**DH40T****USA SPORTSMAN'S HONING SET**

- Mounted Soft/Hard Arkansas Stones
- 1 oz. Bottle Premium Honing Oil

Overall Length
8.4" (21.3 cm)

Weight
9.9 oz.

UPC
044356227070



180/320 Grit

SS0TCP**DOUBLE-SIDED SHARPENING STONE**

Overall Length 6" (15.2 cm)

Weight 1 lb. 0.4 oz.

UPC 044356218824

HS1**HONESTEEL**

Overall Length 7" (17.8 cm)

Weight 6.2 oz.

UPC 044356200649

**SCHDD5****DIAMOND DUST SHARPENING STONE**

Sharpening Rod 3.3" (8.4 cm) UPC 044356000253

Handle Length 1.4" (3.6 cm) **SCHDDSCP CLAM**

Weight 1.2 oz. UPC 044356000277

PREMIUM QUALITY LEATHER SHEATHS

CARRY WITH STYLE. OLD TIMER® AND UNCLE HENRY® PREMIUM LEATHER SHEATHS ARE WELL-CRAFTED TO ENSURE YOUR KNIFE IS KEPT PROTECTED THROUGHOUT YOUR TOUGHEST SITUATIONS.



LS1

OLD TIMER® LEATHER SHEATH

Overall Length 4.4" (11.1 cm) UPC 044356201967
Weight 1.6 oz.



LS2

OLD TIMER® LEATHER SHEATH

Overall Length 5.8" (14.7 cm) UPC 044356201674
Weight 1.9 oz.



LS6

UNCLE HENRY® LEATHER SHEATH

Overall Length 5.9" (15.0 cm) UPC 044356228299
Weight 2.4 oz.

SCSK1

SCHRADE® SURVIVAL KIT

Overall Length 3.4" (8.7 cm) UPC 044356223287
 Weight 1.1 oz.

SCSK1 INCLUDES:

- Waterproof Case
- Compass w/Whistle
- (6) - Matches
- Match Strike
- (2) - Needles
- (2) - Fishing Hooks
- (2) - Split Shots
- Fishing Line



SCHRADE® 550 PARACORD BRAIDED LANYARD

SCH550BK SCH550GR SCH550BKGR
 UPC 044356224451 UPC 044356224475 UPC 044356224468

• SCH550BK



SCHFS1

SCHRADE® FERRO ROD FIRE STRIKER

Overall Length 4" (10.1 cm) UPC 044356221016
 Weight 1.1 oz.

SCHFS2

SCHRADE® LARGE FERRO ROD

Overall Length 6" (15.2 cm) UPC 044356229616
 Weight 3.9 oz.

6" WINDOW DECALS & STICKERS**OLD TIMER®***OTD1 (Window Decal)*

UPC 044356221881

OTS1 (Sticker)

UPC 044356223812

SCHRADE®*SCHD1 (Window Decal)*

UPC 044356221887

SCHS1 (Sticker)

UPC 044356223799

UNCLE HENRY®*UHD1 (Window Decal)*

UPC 044356221874

UHS1 (Sticker)

UPC 044356223805

**SCHQ51****SCHRADE® 12W LED SIGN**

UPC

044356224161



- UL Approved
- 110 Volt



• **SCHRADE® HEADER FOR TBD1**

HSC UPC 044356224154



TBD1

SCHRADE® ROTATING COUNTER DISPLAY

UPC

044356224079

SCHRADE® PLEXIGLASS DISPLAYS

PLEXBR (Resting Display)

UPC

044356224055

PLEXSD (Standing Display)

UPC

044356224048



Uncle Henry



SC204 - PANEL 1

UPC 044356217613

440T
120T
30T
340T
770T
940T
50T
80T
330T
1080T
10110T
110T
8580T
90T



SC204 - PANEL 2

UPC 044356217620

11UH
834UH
12UH
124UH
885UH
877UH
897UH
804UH
285UH
16UH
5UH
LB5
LB7



SC204 - Panel 3

UPC 044356217637

440T
120T
30T
940T
330T
340T
5UH
LB5
80T
12UH
897UH
11UH
124UH
285UH



SC204 ROTATING COUNTER DISPLAY

UPC 044356217606

DISPLAY UNITS

- Vacuum Formed Panels
- Each Display Utilizes Steel Panels with Movable Magnets for Product Placement
- **SC204** Two-Sided Rotating Display with Lockable Inside Storage
- **SC500** Lockable Display with Inside Storage



Uncle Henry's



**SC500
FLOOR DISPLAY**

UPC 044356217644

SC500 - PANEL 1

UPC	044356217651
440T	80T
1250T	330T
30T	1080T
340T	180T
770T	110T
940T	8580T
50T	690T



SC500 - PANEL 2

UPC	044356217688
834UH	877UH
897UH	285UH
885UH	124UH
707UH	5UH
11UH	LB5
16UH	LB7
804UH	



SC500 - PANEL 3

UPC	044356217675
1580T	510T
1520T	1560T
1650T	227UH
1600T	162UH
150T	153UH



SC500 - PANEL 4

UPC	044356217682
180T	897LHP
1080T	12UH
940T	834UH
440T	285UH
80T	885UH
50T	LB7
124UH	



SC500 - PANEL 5

UPC	044356217699
770TW	30T
340TW	330T
940TW	11UH
440TY	340T
940TY	5UH
80TY	LB5
8580T	897UH





SWPED

SMITH & WESSON® FLOOR PEDESTAL DISPLAY

- Features Trap Door for Extra Storage

UPC

044356708772



SWB1/SWS1

SMITH & WESSON® 6" DECAL & STICKER

SWD1 (Window Decal)

UPC

028634708796

SWS1 (Sticker)

UPC

028634708789



SWPLEXSD
SMITH & WESSON® PLEXIGLASS STANDING DISPLAY

UPC
028634707577

TBD1
S&W® ROTATING COUNTER DISPLAY

- Magnetic Display
- Extra Storage

UPC
044356224002

HSW
S&W® TBD1 DISPLAY HEADER

- Smith & Wesson® Header for Rotating Counter Display

UPC
028634707399





**WHOLESALE CATALOG
2021**

ISSUE: 007 7-26-21